

EN

Operating Manual

Filter with Flanged Connections

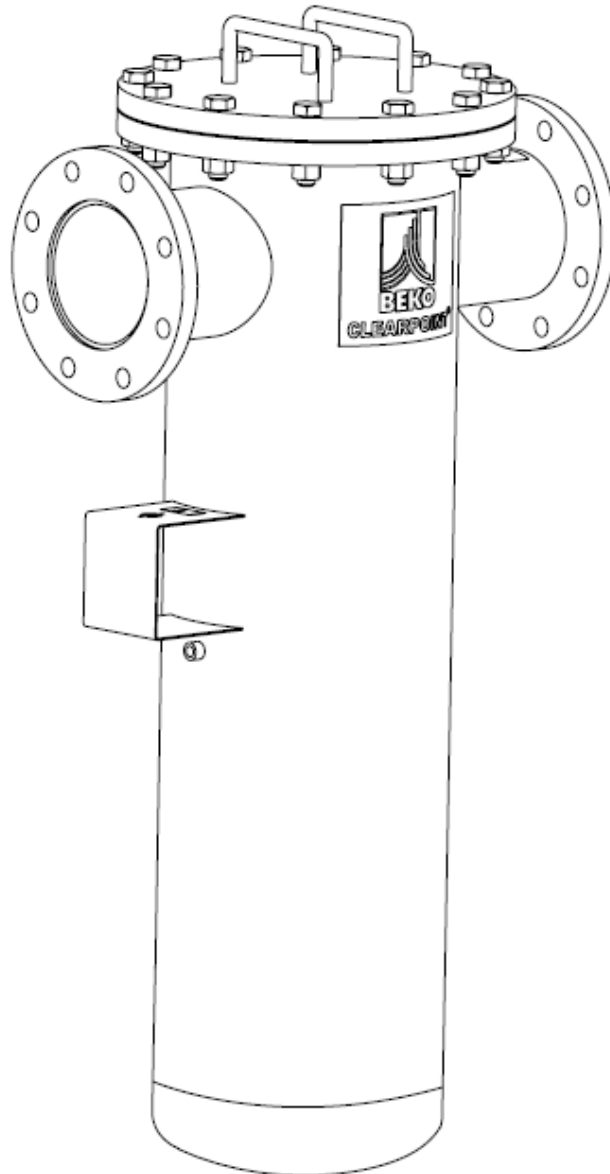

CLEARPOINT® Flange Filter Series

models L100 to L304

READ MANUAL FIRST BEFORE INSTALLATION AND OPERATION

















Table of Contents

DEFINITION OF THE SAFETY SYMBOLS	3
WARNINGS	3
INTRODUCTION	4
RECEIVING AND TRANSPORTING	5
SAFETY RULES	5
AREAS OF APPLICATION	6
FUNCTION	6
ECONOMIC EFFICIENCY OF FILTERS	6
TECHNICAL SPECIFICATIONS OVERVIEW	7
CORRECTION FACTORS	7
DIMENSIONS	8
INSTALLATION SITE	9
POSITIONING	9
INSTALLATION	9
CHECKS AND MAINTENANCE	10
FILTER ELEMENT REPLACEMENT	11
BOLT TORQUE TABLE (FT-LBS)	12
BOLT MARKING REFERENCE	12
BOLT PATTERN REFERENCE	13
BOLT PATTERN REFERENCE (con't)	13
ACCESSORIES	14
SPARE PARTS	15

For technical product support please call+1 (800) 235-6797 and select Option 2

DEFINITION OF THE SAFETY SYMBOLS

					
Before attempting any service, please read the manual	General Warning: Risk of damage or injury	Electrical Hazard: Possibility of electrocution	Warning: Under pressure	Warning: High temperature	Warning: Non-breathable air
					
Warning: Water cannot be used to extinguish fire	Warning: Do not operate if parts are missing or have been tampered with	Warning: Unit level noise may exceed 85 dBA	Warning: Hearing protection required	Warning: All work to be performed by qualified personnel only	Operations that can be performed by qualified operators ¹
					
Compressed air inlet connection		Compressed air outlet connection		Connection point for condensate drain	

¹ Only experienced and trained personnel familiar with all of the relevant laws, rules and regulations, capable to perform the needed activities and to identify and avoid possible dangerous situations while handling, installing, using and servicing the unit.

WARNINGS

WARNING: VESSELS UNDER PRESSURE

- + In most countries, states, cities and/or local municipalities the installation, operation and maintenance of units where pressure vessels are in use are subject to local boiler and pressure vessel regulations.
- + The end user is responsible for following all of the relevant laws, rules and regulations and ensuring that only experienced and trained personnel install and/or maintain filter assembly.
- + In most countries, states, cities and/or local municipalities the installation may only be carried out by a licensed installation company. Inspections must be carried out by a qualified and licensed third-party firm in accordance with all applicable laws, rules and regulations for the region where the filter is installed.
- + The pressure vessels used in this unit are built according to the American Society of Mechanical Engineers (ASME) standard Section 8, Division 1.



Compressed Air Warning:

Compressed air is a highly dangerous energy source.

- + Never work on the filter while components are under pressure.
- + Never point the compressed air stream or the condensate drain outlet towards anybody.

The end user is responsible for the installation of the filter as laid out in this manual. If proper commissioning steps are not followed, the warranty will be void and dangerous situations involving injury or death and/or damages to the unit could occur.

Only qualified personnel can use and service electrically powered units. Before attempting any maintenance:

- + Ensure that no part of the unit is powered and is locked out of the electrical mains by following proper "Lock-out, Tag-out" procedures and requirements.
- + Ensure that no part of the filter is under pressure by isolating the filter from the compressed air system.



Any change to the unit or to the standard operating parameters (see page 5), if not previously verified and authorized by the manufacturer, in addition to creating a potentially dangerous situation, will void the warranty.



Don't use water to extinguish fire on the filter or in the surrounding area.

INTRODUCTION



These instructions for installation and operation will help you to become more familiar with the CLEARPOINT® filter and enable you to utilize the unit within the intended scope of application. Furthermore, the instructions contain important information for ensuring safe, correct and economic operation.



The individual directions have to be followed precisely as described in order to avoid hazards or damage.

Additionally, it will be necessary to observe the accident prevention regulations valid in the operator's country and at the place of installation together with the approved rules of engineering practice concerning correct safety and work procedures.



All persons carrying out the installation, commissioning, maintenance or repair of the product on the operator's premises must have read and understood these instructions for installation and operation. The instructions should be permanently available at the place of installation.

CLEARPOINT® filters are built according to the state of the art and the approved safety rules of engineering practice. However, the use of the product can endanger the health and life of attending personnel or third parties and can have a considerable negative effect on the product itself or on the other material assets if:



- + The personnel are not properly trained.
- + The product is used for purposes other than the intended application.
- + The unit is not correctly serviced or maintained.

This could render the guarantee invalid

CLEARPOINT® filters are designed for gaseous neutral media without any aggressive substances. Non-observance of this condition excludes all liability claims.

BEKO TECHNOLOGIES reserves the right to implement changes at any time, while retaining the essential features of the CLEARPOINT® filter, if such changes become necessary to enhance the technical capacity of the unit for reasons of safety or standard commercial practice.

RECEIVING AND TRANSPORTING

CLEARPOINT® filters undergo stringent quality control procedures in the manufacturing plant and are handed over to the forwarding agent in perfect condition. Upon arrival of the goods, please check for any visible damage and, where appropriate, insist on a corresponding note on the delivery receipt. Contact the forwarding agent and arrange for an assessment of the damage. The manufacturer is not responsible for any damage caused during transport.

After verification of the packaging upon receipt, place the unit as close as possible to the installation point before unpacking the contents.

- + To move the packaged unit, we suggest the use of a suitable crane or forklift. We do not recommend moving the unit by any hand operated or manual mechanism.
- + Handle with care. Heavy blows could cause irreparable damage.
- + Even when packaged, keep the unit protected from severe weather.



The packaging materials are recyclable. Each material must be properly disposed in a manner complying with the rules and regulations of the local municipal government.

SAFETY RULES

- The personnel carrying out the installation, commissioning, maintenance or repair of the unit must be properly qualified for this type of work. In particular, the persons concerned should
 - + Be trained and familiar with handling compressed- air systems and be informed about the associated dangers.
 - + For CLEARPOINT® filters equipped with a BEKOMAT® drain, the BEKOMAT® operating manual must also be read, understood and respected.
 - + Know the content of the relevant instructions for installation and operation, and
 - + Possess vocational qualifications or entitlements in this particular field of work.



- Before the start of any work, the housing must first be depressurized.
- In the case the CLEARPOINT® filters with BEKOMAT® drains all the rules of the separated instructions need to be complied with as well.
- To ensure safe functioning, only use the unit within the operational limits (operating pressure, operating temperature, volumetric flow, and material stability).
- Where a BEKOMAT® is installed, it must be ensured the unit is designed for the stated volumetric flow of the compressed air or gas. Condensate surges into the unit can impair the function.
- In the event of leaks, shut off the compressed air supply immediately and eliminate the cause in order to maintain safe and cost-effective operation.

- CLEARPOINT® filters, including accessories, must be checked once a week. This applies in particular to the function of the drain. Please refer to page 10 check list.

AREAS OF APPLICATION

CLEARPOINT® filters are designed for the separation of solid particles, aerosols, oil vapors and orders from non-aggressive compressed air or industrial gases. Depending on the specific application, the filter housings are provide with different insert:

C Coarse filter for the separation of coarse solid matter pollutants up to 25 µm

G General Purpose filter element for the separation of large dirt particles up to 5 µm

F Fine filter element for the separation of liquids up to 0.1 mg/m³ and solid particles up to 1 µm

S Super fine filter element for the separation of liquids up to 0.01 mg/m³ and solid particles up to 0.01 µm

N Nano filter element for the separation of liquids up to 0.003 mg/m³ and solid particles up to 0.01 µm

A Activated carbon filter elements for the separation of oil vapors up to 0.003 mg/m³ and odors

R (x) Dust filter for the separation of solid particles, fineness depends of the grade. Refer to C to N above.

FUNCTION

Filter C, G, F, S, and R(X)

Solid particles are separated by impact and inertia effect, oil and water aerosols by coalescence effect. Due to gravity, filtered out liquid particles gather in the lower part of the filter housing from where they are discharged either manually or automatically. With coalescence filters the direction of flow through the filter elements is from the inside to the outside; with dust filters the flow moves from outside to inside.

Activated carbon filter A

The flow through the activated carbon bed proceeds from the inside to outside. Oil vapors and odors are adsorbed on the activated carbon. The carbon is incorporated into a binding fabric which ensures the reliable retention of dust particles.

ECONOMIC EFFICIENCY OF FILTERS

Surface and depth filters

Series C, G, F, S, and R(X)

In the course of time, particles accumulate in the filtration medium and reduce the space available for flow. Consequently, the flow resistance will gradually increase, which is indicated on the differential pressure gauge.

It is recommended to replace the filter elements at a differential pressure of 10 psi or at least once a year, whichever comes first. If the element replacement is delayed any longer, the economic efficiency will suffer since the higher differential pressure has to be compensated by the by the upstream compressor. This will push up the electricity consumption and lead to greater wear on the compressor.

Activated carbon filter, Series A

In order to prolong the service life of the elements, the residual moisture of the inflowing gas should not exceed 80%. Elements will reach loading capacity after approximately 6 months, requiring replacement at that time.

The nominal diameter of the pipes should be as uniform as possible in order to avoid creating additional flow resistance. Reduced pipe sections should only be installed where required for partial-flow outlets (ring, connecting or supply lines).

TECHNICAL SPECIFICATIONS OVERVIEW

Model	Pipe Size ANSI Flange	Flow Rate)scfm	A In	B In	C1 In	C2 In	D In	Volume Gallons	Weight Lbs.	Filter element **)
L100	4" FLG	1900	20.25	6.875	76.20	59.50	13.00	10.00	195	88(Typ)2 x
L102	4" FLG	2800	20.25	7.125	60.50	47.50	13.00	16.00	266	88(Typ)3 x
L150	6" FLG	3800	23.50	8.00	60.00	47.00	13.00	17.00	328	88(Typ)4 x
L156	6" FLG	6500	23.75	8.25	64.30	50.00	14.30	26.00	360	88(Typ)7 x
L200	8" FLG	7500	28.00	9.50	67.30	53.00	14.30	32.00	469	88(Typ)8 x
L204	8" FLG	9300	27.95	9.65	67.60	53.30	14.30	44.11	575	88(Typ)10 x
L254	10" FLG	13000	34.65	8.50	69.06	54.76	14.30	70.00	761	88(Typ)14 x
L304	12" FLG	21000	38.95	11.02	74.69	60.39	14.30	107.50	1135	88(Typ)22 x

*) Volumetric flow at 100 psi operating pressure, related to 68°F (20 °C) and 14.5 psi absolute(1.0 bar). Validated in accordance with ISO 12500-1, INLET CONCENTRATION 5-15mg/m³



**) When ordering, please state the required quantity of filter elements and the degree of filtration (type).

***) Coalescing filter = Residual aerosol content
Activated carbon filter = residual vapor content

Type	Description	Solid Particles µm	Residual Oil Content mg/m ³ ***)
C	Coarse filter	25	1010
G	General purpose filter	5	5
G	Fine filter	0.1	1
S	Super fine filter	0.01	0.01
A	Activated carbon filter	-	0.003
R (typ)	Dust filter	Type	Type

CORRECTION FACTORS

Operating Pressure

Inlet air pressure	psig	20	40	60	80	90	100	120	130	140	160	180	200
Factor	P ₁	0.30	.48	.65	.82	.91	1.00	1.17	1.26	1.35	1.52	1.70	1.87

- For the maximum volume flow, multiply the model volume flow shown in the table by the correction factor corresponding to the working pressure.

DIMENSIONS

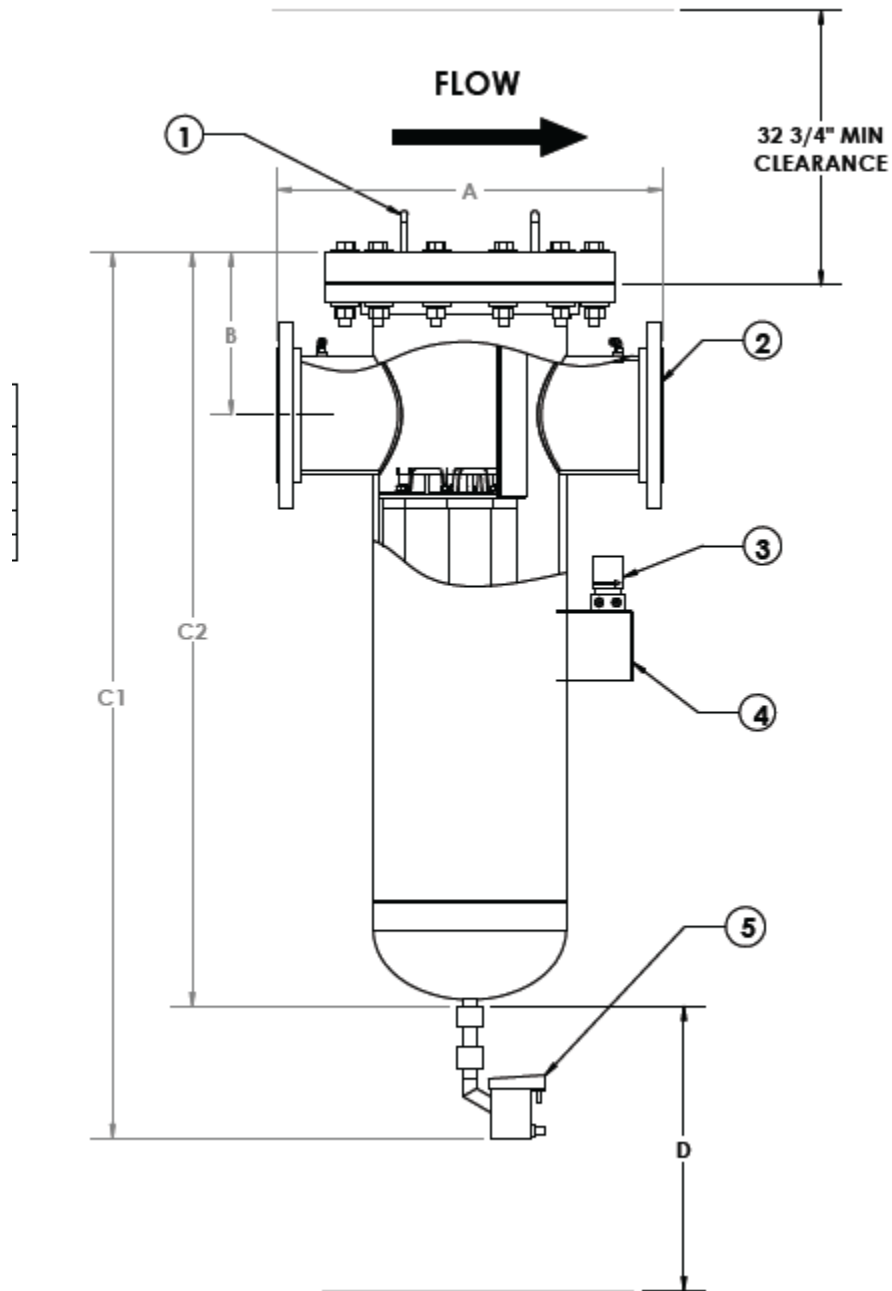

Component list

1. Flange Handles
2. ANSI 150# Flanged Connection
3. Differential Pressure Gauge
4. ASME Data Plate
5. BEKOMAT Zero Loss Condensate Drain

INSTALLATION SITE



Serious consideration should be given when selecting the installation site for the filter, as an improper location could directly affect the proper operation of the filter.

This unit is not suitable for use in explosive atmospheres, where risk of fire could exist, in the presence of gaseous or solid pollutants or in outdoor applications or areas exposed to the elements.



Don't use water to extinguish fire on or in the area surrounding filter installation.



Technicians that service the CLEARPOINT® Flange filter must wear hearing protection while servicing the filter. Each employee must select a proper personal protection unit (PPD) for hearing protection such as earmuffs, ear canal caps or earplugs in order to prevent permanent damage or loss of hearing

Minimum Installation Requirements:

- + Select a clean, dry room that is free of dust and protected from atmospheric disturbances.
- + Maximum operating pressure of 200 psig
- + Minimum operating temperature of +35 °F
- + Maximum operating temperature of +140 °F
- + Allow a clearance of at least 3' on all sides of the filter in order easily facilitate all maintenance needs.

POSITIONING

The housing should be mounted in a vertical position. Observe the direction of flow which is indicated by an arrow on page 8 of the dimensional drawing, note that this is the standard flow. All reverse flow units will flow from the outside into the filters.

For replacing the filter elements, it is necessary to leave a handling space of 34 in above the filter.

INSTALLATION

For better filter efficiency, it is recommended to install the unit at a preferably cool, but frost-protected point along the pipe network.

The separation rate and service life figures assume filtration using pre-filters of the next coarser grade (exception; coarse filter series C).

Furthermore, it is recommended to install a shutoff valve both on the inlet and the outlet side of the filters or filter combination. A bypass line with an additional shutoff valve should be installed so that the pipe network can still be supplied with compressed air during routine maintenance work.



Pre-filter, and depth filters are supplied with an electronically level-controlled condensate drain, type BEKOMAT®, as standard. Please observe the instructions in the corresponding documentation.



DO NOT DISPOSE OF THE CONDENSATE INTO THE ENVIRONMENT

The condensate collected in the filter contains oil particles released into the air stream by the compressor. Dispose the condensate in compliance with all local, state and Federal rules and regulations. We highly recommend the installation of either a QWIK-PURE® or ÖWAMAT® oil-water separator at the final collection point for all condensate discharge lines within the facility (i.e. from the main header).

CHECKS AND MAINTENANCE

To guarantee high operation and functional safety, regular checks are necessary. Any discovered defects must be immediately reported to the competent department.

For an emergency, a possibility for the shut-off of the plant section must be provided.

Daily:

Carry out a general visual inspection

- External damage and defects
- Visually check for any leaks
- Check differential pressure gauge, Pressure drop increases as element loads with solid particles. Replace when pressure reaches 10 psi or you see the indicator in the red.
- Test drain function

Monthly:

- External damage and defects
- Visually check for any leaks
- Check differential pressure gauge, Pressure drop increases as element loads with solid particles. Replace when pressure reaches 10 psi or you see the indicator in the red.
- Test drain function

Annually:

- External damage and defects
- Visually check for any leaks
- Check differential pressure gauge, Pressure drop increases as element loads with solid particles. Replace when pressure reaches 10 psi or you see the indicator in the red or annually whichever occurs first.
- Service drain, replacement of service unit. Refer to the BEKOMAT® Drain manual for proper maintenance.

Watch for noticeable problems and possible failures during the running operation.

FILTER ELEMENT REPLACEMENT

- Where appropriated, close shutoff valves at gas inlet and outlet
- Depressurize the housing, this can be accomplished by pushing the test button on the BEKOMAT® drain installed on the bottom port.
- Unbolt top lid. You can use the last flange screw as a pivot. The lid is then simply turned aside to provide full access.
- Subsequent to the loosening of two nuts and a slight turn in clockwise direction, the filter elements, along with the tie rod unit, may be completely removed from the housing.



- Unscrew the filter elements counter-clockwise from the tie rod unit.
- Replace the O-ring of the tie rod unit to ensure proper seal to the filter plate.
- Screw new filter elements onto the treaded rod (finger tight 4.7 Nm, without tools) and place unit into the housing. Retighten the nuts in order to secure the tie rod unit.
- Replace flange gasket on top
- When reassembling the lid to the vessel, confirm the bolt, flat washer, lock washer and nut are assembled in this order. The lock washer will always be on the vessel side of the assembly.
- Lubricated bolt threads in area of nut engagement
- Install all bolts and nuts finger tight.
- After you have installed all the bolts with flat washer on top and lock washer on bottom proceed to number the bolts according appropriate bolt patterns listed on page 12 & 13
- Apply torque in 20% (1/5) steps of required final torque, loading all bolts at each step before proceeding to next step. Refer to torque values on page # 12
- Tighten bolts in sequential order at each step until final torque is reached. Refer to torque values located on page 12.
- Use rotational tightening until all bolts are stable at final torque level. Two completed rotations are required.
- Slowly admit pressure to the filter by gradual opening of the shutoff valves.

- Bubble check all fittings for leaks.
- Make a note of the date for the next element replacement on the housing, the maintenance schedule and the label supplied with the elements. Stick the label on a part of the filter housing where it can easily be seen. Re-order new elements and, service kit for the automatic drain to ensure an adequate stock of spare parts.

BOLT TORQUE TABLE (FT-LBS)

PIPE SIZE	BOLT QTY	BOLT SIZE	307A/Grade A (for 150 psig only)	Grade 5 150# FLANGE		Grade 5 300# FLANGE	
				MIN	STD	MIN	STD
4"	8	5/8"-11	60	63	120	94	200
5"	8	3/4"-10	100	88	200	117	200
6"	8	3/4"-10	100	111	200	99	200
8"	8	3/4"-10	100	150	200	160	320
10"	12	7/8"-9	160	141	320	185	490
12"	12	7/8"-9	160	187	320	269	710
14"	12	1"-8	245	238	490	234	652
16"	16	1"-8	245	226	490	328	912
18"	16	1-1/8"-7	355	336	710	371	1000
20"	20	1-1/8"-7	355	296	710	409	1000
24"	20	1-1/4"-7	500	422	1000	579	1552

BOLT MARKING REFERENCE

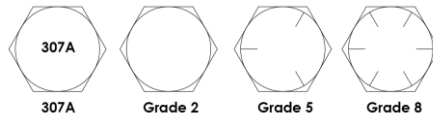

BOLT PATTERN REFERENCE

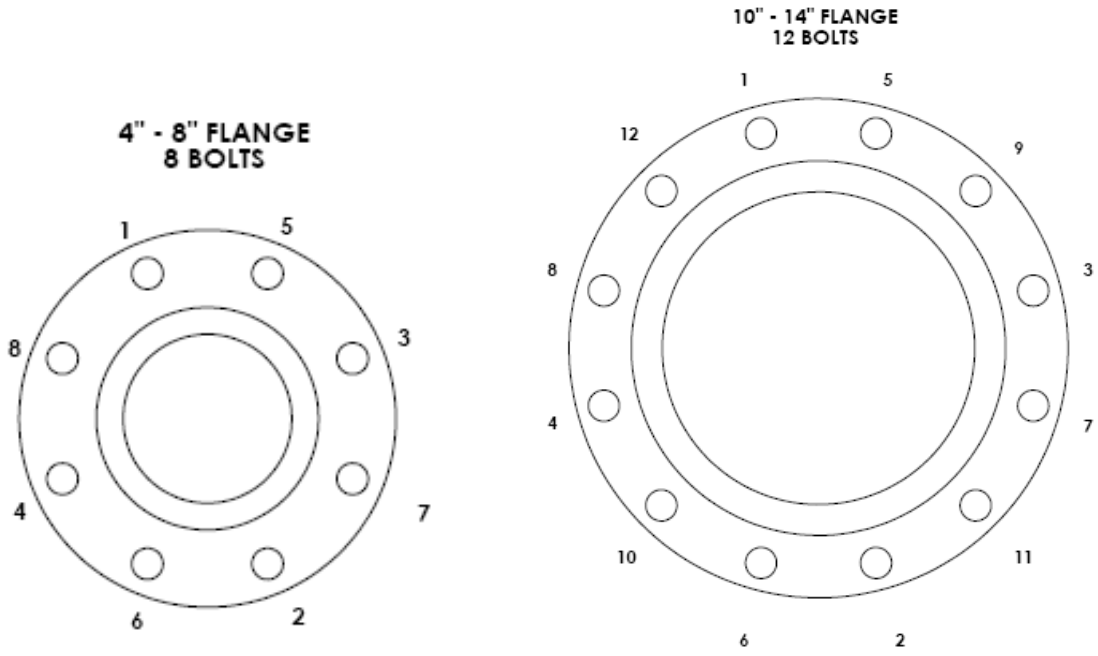

BOLT PATTERN REFERENCE (con't)

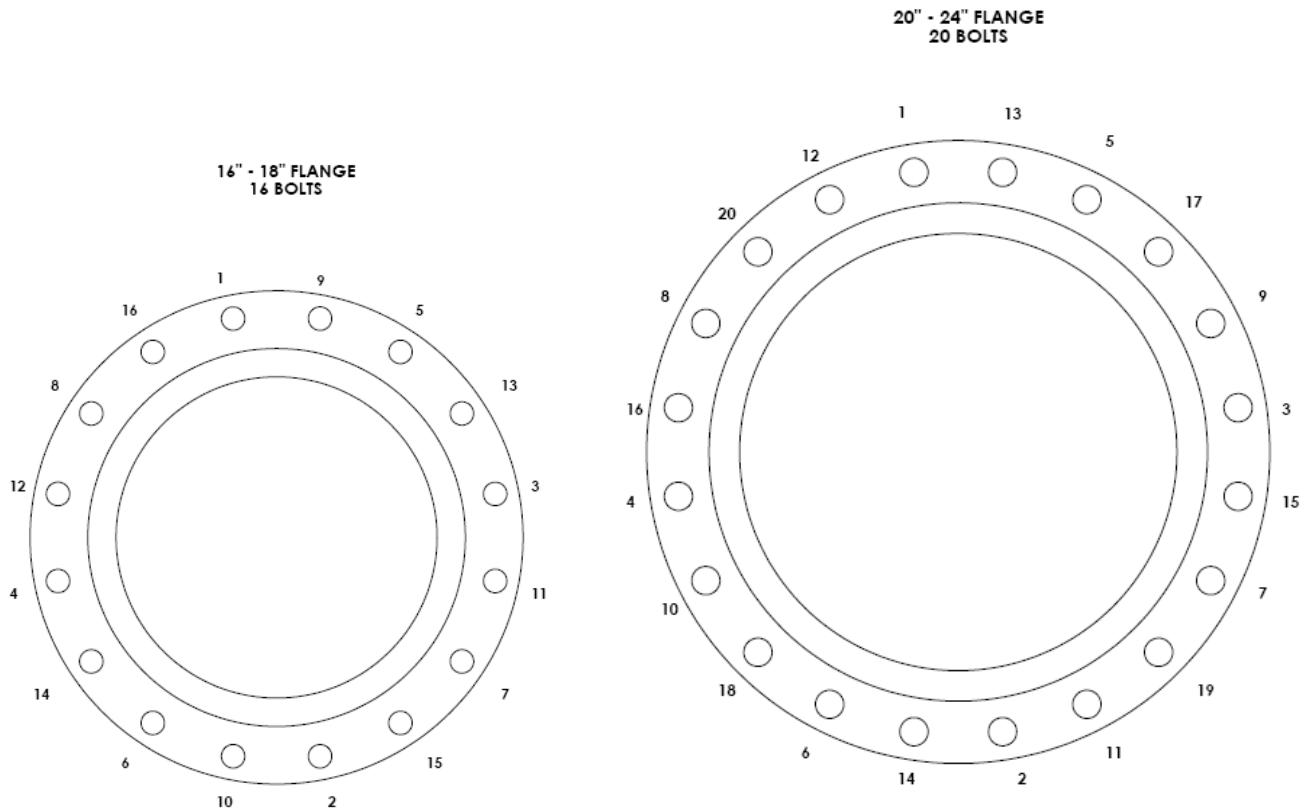

ACCESSORIES

Differential-pressure gauge

Differential-pressure gauges are used to determine the condition, i.e. the degree of fouling, of the filter elements. The scaling on the display field also allows an energy cost analysis.

The FDPS differential-pressure gauge has two pressure chambers which are separated by a membrane. One chamber relates to the pressure upstream, the other one to the pressure downstream of the filter element. Any existing pressure difference changes the position of the membrane and thus the position of the magnetic piston. The pistons changed magnetic field is transferred to the pointer without friction. Measuring system and indication system are separate from the each other. Therefore, the indicating system functions without pressure, and contaminants from the gas side cannot soil the display field.

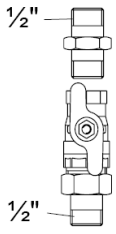
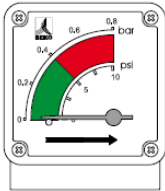
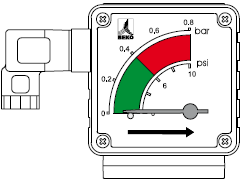
 <p style="text-align: center;">1/2" 1/2"</p>	<p style="text-align: center;">Connection set BEKOMAT® 32 Vario® L100 – L304</p>	<p style="text-align: center;">Order reference 2002228</p>
	<p style="text-align: center;">Differential pressure gauge</p>	<p style="text-align: center;">Order reference FDPS</p>
	<p style="text-align: center;">Differential pressure gauge with potential free contacts</p>	<p style="text-align: center;">Order reference FSSPDIWE</p>

SPARE PARTS

Model	C 25 µm	G 5 µm	F 1 µm	S 0.01 µm	A 0.003 ppm	Order Quantity Filter elements	LID Gaskets	BEKOMAT Service unit	BEKOMAT Drain
L100	88C	88G	88F	88S	88A	2	4032958	4023573	4025091
L102	88C	88G	88F	88S	88A	3	4032959	4023573	4025091
L150	88C	88G	88F	88S	88A	4	4032959	4023573	4025091
L156	88C	88G	88F	88S	88A	7	4032960	4023573	4025091
L200	88C	88G	88F	88S	88A	8	4032961	4023573	4025091
L204	88C	88G	88F	88S	88A	10	4032962	4023573	4025091
L254	88C	88G	88F	88S	88A	14	4032963	4023573	4025091
L304	88C	88G	88F	88S	88A	22	4032964	4023573	4025091

For technical product support please call +1 (800) 235-6797 and select Option 2

The product categories

 **Condensate drainage**
BEKOMAT®

 **Filtration**
CLEARPOINT®

 **Measurement technology**
METPOINT®

 **Condensate processing**
ÖWAMAT® | QWIK-PURE® | BEKOSPLIT®

 **Drying**
DRYPOINT®

 **Process technology**
BEKOKAT®



BEKO TECHNOLOGIES CORP.
900 Great Southwest Pkwy SW
Atlanta, GA 30336
USA
Phone +1 (404) 924-6900
Fax +1 (404) 629-6666
beko@bekousa.com
www.bekousa.com



Subject to technical changes without prior notice; the information provided does not represent characteristics of state within the meaning of the German Civil Code (BGB).
© Registered Trademarks by BEKO TECHNOLOGIES GmbH, Neuss, Germany and BEKO TECHNOLOGIES CORP, Atlanta, GA USA.