

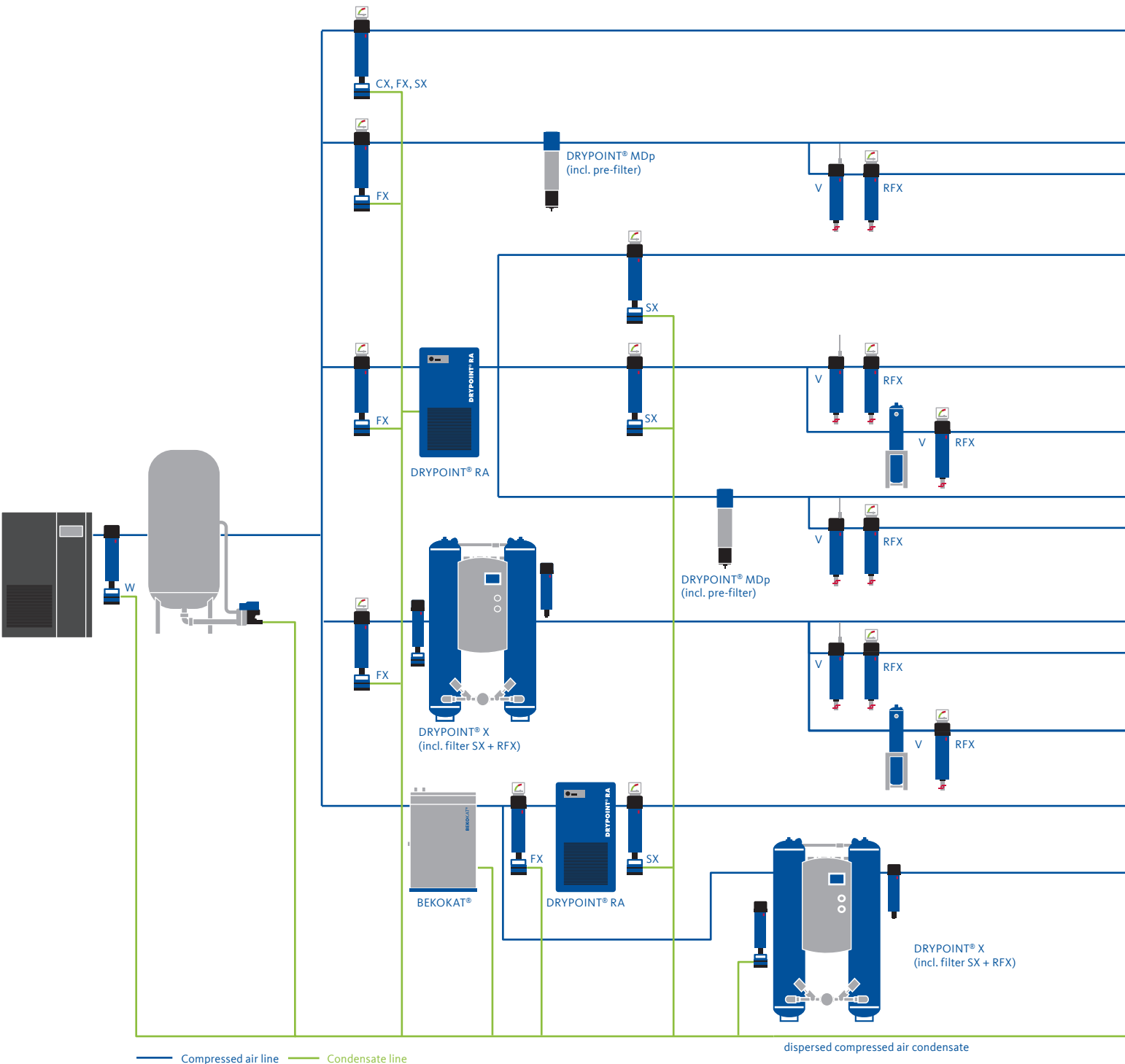

2023 PRICE BOOK

Complete compressed air processing at a glance:



your single source of supply and quality you can rely on.

Solid particles Pressure dew point Oil/oil vapor

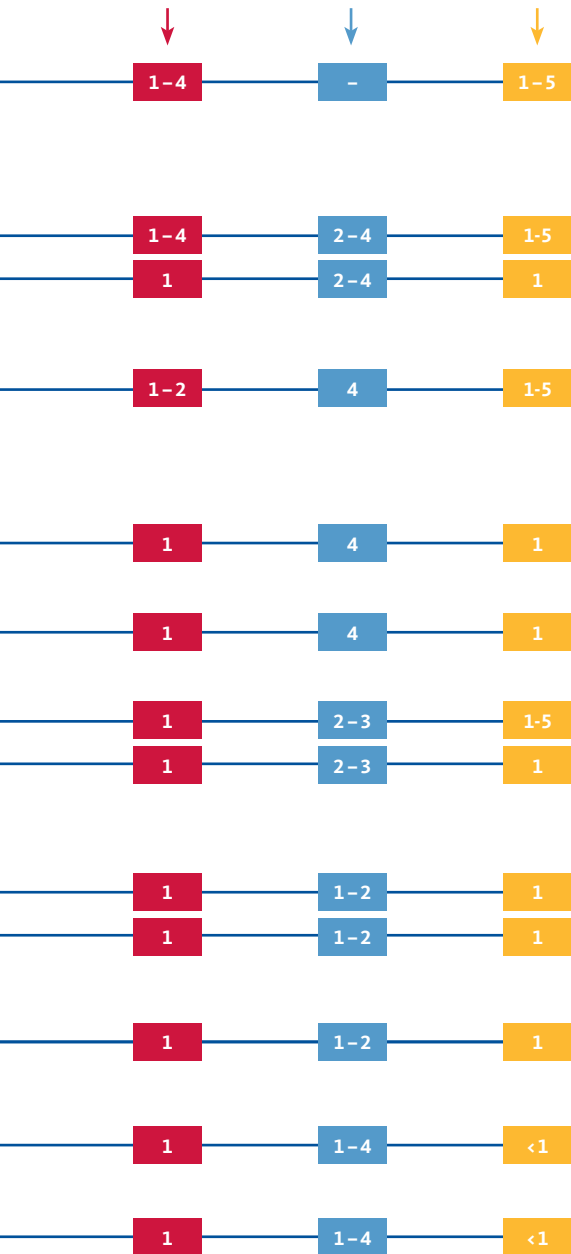

Air quality classes in accordance with ISO 8573-1:2010

Class	Solid particles, max. number of particles per m ³			Pressure dew point °F	Oil content (liquid, aerosol, oil vapor) mg/m ³
	0.1 µm < d ≤ 0.5 µm	0.5 µm < d ≤ 1.0 µm	1.0 µm < d ≤ 5.0 µm		
0	In accordance with the unit operator's or supplier's specifications, stricter requirements than class 1				
1	≤20,000	≤400	≤10	≤-100	≤0.01
2	≤400,000	≤6,000	≤100	≤-40	≤0.1
3	-	≤90,000	≤1,000	≤-4	≤1
4	-	-	≤10,000	≤37	≤5
5	-	-	≤100,000	≤45	>5
6	-	-	-	≤50	-

■ Measured in accordance with ISO 8573-4, ref. conditions 14.5 psi [a] absolute, 68 °F, 0% RH

■ Measured in accordance with ISO 8573-3

■ Measured in accordance with ISO 8573-2 and ISO 8573-5, ref. conditions 14.5 psi [a] absolute, 68 °F, 0% RH

	CLEARPOINT® dust filter RFX/RSX with manual drain with differential pressure indicator		DRYPOINT® RA refrigeration dryer with BEKOMAT®
	CLEARPOINT® coalescence filter CX/FX/SX with BEKOMAT® with differential pressure indicator or filter management		DRYPOINT® MDp / MDi membrane dryer with an integrated nanofilter and adjustable PDP (MDi only)
	CLEARPOINT® A activated carbon filter Option: oil check indicator		DRYPOINT® MDe membrane dryer
	CLEARPOINT® V activated carbon cartridge with oil check indicator		DRYPOINT® X desiccant dryer with inlet and dust filter
	CLEARPOINT® V activated carbon adsorber		BEKOKAT® catalytic converter for oil and bacteria free air
	CLEARPOINT® W water separator with BEKOMAT®		BEKOMAT® intelligent zero air loss condensate drains
	ÖWAMAT® / QWIK-PURE® oil-water separation system for dispersed and emulsified condensates		

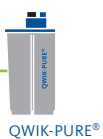



Contents

CLEARPOINT®

Compressed Air Filtration

Threaded Water Separators	8
Threaded Coalescing and Particulate Filters	10
Threaded Vapor Removal	14
Threaded Activated Carbon Cartridge	15
Flanged Water Separators	16
Flanged Coalescing and Particulate Filters	17
Activated Carbon Adsorption Towers	18
Threaded Compressed Air Heater	19
High Pressure Water Separators and Filters (725 psig)	20
High Pressure Stainless Steel Filters (7,250 psig)	24
Accessories	26
Maintenance and Spare Parts	27

DRYPOINT® RA

Refrigerant Air Dryers

RAc Economy Series Dryers	34
RAx Premium Series Dryers	36
RA CT Series Cycling Dryers.....	40
RA VSD Series Variable Speed Dryers	42
RA HT High Temperature Series (210 °F)	44
RS HP High Pressure Series (725 psig)	46
RA LC Series Air and Gas Chillers	48
Maintenance and Spare Parts	50

DRYPOINT® X

Desiccant Air Dryers

ACC Compact Heatless Series	70
XCe Economy Heatless Series	72
XCp Premium Heatless Series	74
NEW XFe Economy Heated Blower Series	78
NEW XFi ecoIntelligent Heated Blower Series	80
ACH Heated Purge Series	82
AC HP High Pressure Series (7,250 psig)	84
Maintenance and Spare Parts	86

DRYPOINT® MD

Membrane Air Dryers

MDe, MDp and FDR Product Selector Chart	94
MDe Economy Series Dryers	95
MDp Premium Series Dryers	96
FDR Series Filter, Dryer, Regulator Packages	97
MDi Product Selector Chart	98
MDi ecoIntelligent Series Dryers	99
Accessories	100
Maintenance and Spare Parts	101



Contents

BEKOMAT®

True Zero Air Loss Drains

Product Selector Chart	104
Standard Series	105
Standard High Pressure Series / Stainless Steel High Pressure Series	106
CV Series / NLV Series for Centrifugal Compressors	107
Low Pressure and Vacuum System Series / Explosion Proof Series	108
Large Capacity Series	109
Accessories	109
Maintenance and Spare Parts	110

QWIK-PURE® & ÖWAMAT®

Oil-water Separation Solutions

QWIK-PURE® Product Selector Chart	116
QWIK-PURE® Oil-water Separators / Spill Protection	117
ÖWAMAT® Product Selector Chart	118
ÖWAMAT® Oil-water Separators / Spill Protection	119
Accessories	120
Maintenance and Spare Parts	121

METPOINT®

Instrumentation and Monitoring

Pre-configured Stationary Dew Point Meters	126
Pre-configured Stationary Flow Meters	127
Pre-configured Compact Multi-function Monitoring Solutions	128
Configurable Compact Multi-function Monitoring Solutions	129
Stationary Oil Vapor Monitoring Systems	132
Accessories	132
NEW Portable Monitoring Devices	133
Maintenance and Spare Parts	135

BEKOKAT®

Hydrocarbon Removal Systems

NEW Advanced Catalytic Conversion Systems	138
Maintenance and Spare Parts	140

DEMO PRODUCTS

WARRANTY AND TERMS

Cutaway, Demo and Educational Products	142
Cover3More Extended Warranty	144
Terms and Conditions	145

COMPRESSED AIR FILTRATION

Alternative Filter Elements for Competitive Housings	147
--	-----



Air Filtration

CLEARPOINT®

energy saving filtration and separation

- › Threaded Water Separators
- › Threaded Coalescing and Particulate Filters
- › Threaded Vapor Removal and Activated Carbon Filters
- › Flanged Water Separators
- › Flanged Coalescing and Particulate Filters
- › High Pressure Water Separators,
- › High Pressure Coalescing and Particulate Filters, and more...

CLEARPOINT® Threaded Water Separators with float drain

- › Removal of large quantities of condensate
- › Used downstream of aftercoolers
- › CRN approved
- › Max. operating pressure: 232 psig
- › Max. operating temperature: 140 °F

Maintenance Interval: < 8,000 hours
Maintenance and Spare Parts: Page 27
Extended Warranty: Page 144

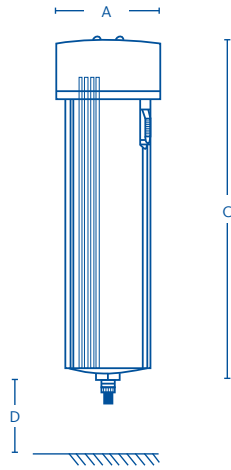

CLEARPOINT®	S040	S045	S050	S075	S100	M010
Pipe Size (NPT)	¾"	½"	½"	¾"	1"	1"
Flow Rate (scfm)	25	30	50	100	125	160
Separator Size	04W	04W	05W	07W	07W	10W

Dimensions and Weight

A (inches)	2.95	2.95	2.95	3.94	3.94	3.94
C (inches)	7.09	7.09	8.27	11.02	11.02	13.78
D (inches)	5.91	5.91	5.91	5.91	5.91	5.91
Weight (lbs)	1.65	1.65	1.87	3.75	4.18	4.63

THREADED WATER SEPARATOR WITH FLOAT DRAIN

Order ref.	4005005	4020216	4004735	4004736	4020380	4004732
Price (\$)	\$225	\$230	\$248	\$325	\$356	\$380

Price Group 82

ELEMENT GRADE	ELEMENT TYPE	Δ PRESSURE (psid)	REMOVAL RATE
Grade W	Water Separator	.87	99.0%

Correction Factors

Operating Pressure (psig)	20	40	60	80	90	100	110	120	130	140	160	180	200	230
Correction Factor	.30	.48	.65	.82	.91	1.00	1.09	1.17	1.26	1.35	1.52	1.70	1.87	2.13

The correction factors on this page provide an estimation of the performance that can be achieved with the model sizes shown. For precise sizing for your application, please contact your BEKO Technologies sales representative.

CLEARPOINT® Threaded Water Separators

with BEKOMAT® and connection kit

ECO CHOICE

- › Removal of large quantities of condensate
- › Used downstream of aftercoolers
- › CRN approved
- › Max. operating pressure: 232 psig
- › Max. operating temperature: 140 °F

Maintenance Interval: < 8,000 hours
 Maintenance and Spare Parts: Page 27
 Extended Warranty: Page 144

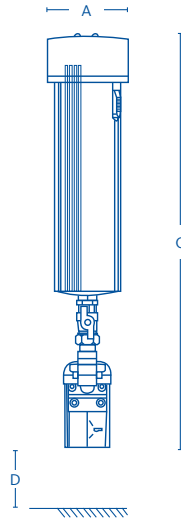

CLEARPOINT®	S040	S045	S050	S075	S100	M010	M015	M019	M020	M022	M025	M030
Pipe Size (NPT)	¾"	½"	½"	¾"	1"	1"	1½"	1½"	2"	2"	2½"	3"
Flow Rate (scfm)	25	30	50	100	125	160	250	450	500	600	1000	1500
Separator Size	04W	04W	05W	07W	07W	10W	15W	20W	20W	22W	25W	30W

Dimensions and Weight												
A (inches)	2.95	2.95	2.95	3.94	3.94	3.94	5.75	5.75	5.75	5.75	10.24	10.24
C (inches)	15.55	15.55	16.73	19.49	19.49	22.24	22.83	26.89	26.89	30.71	34.88	39.76
D (inches)	5.91	5.91	5.91	5.91	5.91	5.91	6.30	6.30	6.30	6.30	7.87	7.87
Weight (lbs)	1.65	1.65	1.87	3.75	4.18	4.63	9.04	10.61	11.24	13.45	43.87	57.10

THREADED WATER SEPARATOR WITH BEKOMAT

Order ref.	4012253	4020244	4012254	4012255	4020397	4012256	4012257	4020440	4012258	4012259	4012260	4012261
Price (\$)	\$419	\$434	\$444	\$521	\$575	\$644	\$973	\$1,130	\$1,158	\$1,232	\$2,506	\$2,690

Price Group 82

ELEMENT GRADE	ELEMENT TYPE	Δ PRESSURE (psid)	REMOVAL RATE
Grade W	Water Separator	.87	99.0%

Correction Factors

Operating Pressure (psig)	20	40	60	80	90	100	110	120	130	140	160	180	200	230
Correction Factor	.30	.48	.65	.82	.91	1.00	1.09	1.17	1.26	1.35	1.52	1.70	1.87	2.13

The correction factors on this page provide an estimation of the performance that can be achieved with the model sizes shown. For precise sizing for your application, please contact your BEKO Technologies sales representative.

CLEARPOINT® Threaded Coalescing and Particulate Filters

with float drain with or without differential pressure gauge and eco series elements

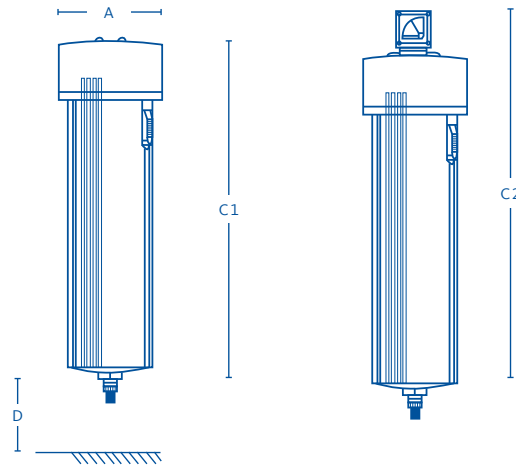

CLEARPOINT®	S040	S045	S050	S055	S075	S100	M010	M012	M015
Pipe Size (NPT)	¾"	½"	½"	½"	¾"	1"	1"	1"	1 ½"
Flow Rate (scfm)	25	30	50	80	100	125	160	200	250
Element Size	04*	04*	05*	06*	07*	07*	10*	12*	15*

Dimensions and Weight

A (inches)	2.95	2.95	2.95	2.95	3.94	3.94	3.94	3.94	5.75
C1 (inches)	7.09	7.09	8.27	10.43	11.02	11.02	13.78	15.16	14.17
C2 (inches)	9.65	9.65	10.83	12.99	13.58	13.58	16.34	17.72	16.73
D (inches)	5.91	5.91	5.91	5.91	5.91	5.91	5.91	5.91	6.30
Weight (lbs)	1.65	1.65	1.87	2.65	3.75	4.18	4.63	4.85	9.04

THREADED FILTER WITH FLOAT DRAIN, WITHOUT GAUGE

Order ref. 25 µm	4041816	4020218	4003292	4014086	4003295	4020382	4003298	4021612	4014969
Price (\$)	\$234	\$250	\$278	\$328	\$374	\$409	\$427	\$494	\$702
Order ref. 1 µm	4002890	4020220	4002891	4002892	4002893	4020305	4002894	4002895	4002896
Price (\$)	\$234	\$250	\$278	\$328	\$374	\$409	\$427	\$494	\$702
Order ref. .01 µm	4002950	4020231	4002951	4002952	4002953	4020384	4002954	4002955	4002956
Price (\$)	\$234	\$250	\$278	\$328	\$374	\$409	\$427	\$494	\$702

THREADED FILTER WITH FLOAT DRAIN, WITH GAUGE

Order ref. 25 µm	4017030	4020232	4014415	4014087	4021611	4020385	4004738	4021614	4014423
Price (\$)	\$287	\$316	\$352	\$403	\$439	\$492	\$522	\$590	\$769
Order ref. 1 µm	4015378	4020234	4005492	4006122	4005841	4020387	4005840	4009992	4016030
Price (\$)	\$287	\$316	\$352	\$403	\$439	\$492	\$522	\$590	\$769
Order ref. .01 µm	4003520	4020235	4005073	4006047	4003404	4020388	4003524	4007053	4003405
Price (\$)	\$287	\$316	\$352	\$403	\$439	\$492	\$522	\$590	\$769

Price Group 82

* ELEMENT GRADE	ELEMENT TYPE	MICRON RATING	OIL CARRYOVER	DRY Δ PRESSURE (psid)	WET Δ PRESSURE (psid)
Grade CX	Coarse	25 µm	5 mg/m ³	.44	.73
Grade FX	Fine	1 µm	.05 mg/m ³	.73	1.9
Grade SX	Superfine	.01 µm	.005 mg/m ³	.87	1.7

- › Advanced CLEARPOINT® eco series elements
- › Validated in accordance with ISO 12500-1 and 3
- › CRN approved
- › Filter for natural gas (CNG) on request
- › Max. operating pressure: 232 psig
- › Max. operating temperature: 140 °F

Maintenance Interval: < 8,000 hours
 Maintenance and Spare Parts: Page 27
 Extended Warranty: Page 144

CLEARPOINT®	M018	M019	M020	M022	M023	M025	M027	M030	M032
Pipe Size (NPT)	1 ½"	1 ½"	2"	2"	2"	2 ½"	2 ½"	3"	3"
Flow Rate (scfm)	330	450	500	600	800	1000	1300	1500	1900
Element Size	18*	20*	20*	22*	23*	25*	27*	30*	32*

Dimensions and Weight

A (inches)	5.75	5.75	5.75	5.75	5.75	10.24	10.24	10.24	10.24
C1 (inches)	16.46	18.43	18.43	22.24	26.89	26.42	30.51	35.24	41.14
C2 (inches)	19.02	20.99	20.99	24.80	29.45	29.98	33.07	37.80	43.70
D (inches)	6.30	6.30	6.30	6.30	6.30	7.87	7.87	7.87	7.87
Weight (lbs)	9.92	10.61	11.24	13.45	15.65	43.87	49.82	57.10	65.92

THREADED FILTER WITH FLOAT DRAIN, WITHOUT GAUGE

Order ref. 25 µm	4016180	4020424	4036332	4025163	4017267	4046879	4046881	4027261	4046883
Price (\$)	\$778	\$906	\$972	\$1,082	\$1,184	\$2,109	\$2,195	\$2,394	\$2,823
Order ref. 1 µm	4002897	4020426	4002898	4002899	4002900	4002901	4002902	4002903	4002904
Price (\$)	\$778	\$906	\$972	\$1,082	\$1,184	\$2,109	\$2,195	\$2,394	\$2,823
Order ref. .01 µm	4002957	4020427	4002958	4002959	4002960	4002961	4002962	4002963	4002964
Price (\$)	\$778	\$906	\$972	\$1,082	\$1,184	\$2,109	\$2,195	\$2,394	\$2,823

THREADED FILTER WITH FLOAT DRAIN, WITH GAUGE

Order ref. 25 µm	4021615	4020428	4013962	4013031	4023011	4022717	4022200	4024259	4020916
Price (\$)	\$836	\$974	\$983	\$1,127	\$1,256	\$2,180	\$2,265	\$2,462	\$2,890
Order ref. 1 µm	4014017	4020430	4011475	4014287	4020281	4003493	4017439	4007154	4016052
Price (\$)	\$836	\$974	\$983	\$1,127	\$1,256	\$2,180	\$2,265	\$2,462	\$2,890
Order ref. .01 µm	4014542	4020431	4003406	4013032	4003407	4021904	4025162	4022499	4016071
Price (\$)	\$836	\$974	\$983	\$1,127	\$1,256	\$2,180	\$2,265	\$2,462	\$2,890

Price Group 82

Correction Factors

Operating Pressure (psig)	20	40	60	80	90	100	110	120	130	140	160	180	200	230
Correction Factor	.30	.48	.65	.82	.91	1.00	1.09	1.17	1.26	1.35	1.52	1.70	1.87	2.13

The correction factors on this page provide an estimation of the performance that can be achieved with the model sizes shown. For precise sizing for your application, please contact your BEKO Technologies sales representative.

CLEARPOINT® Threaded Coalescing and Particulate Filters

with BEKOMAT® and connection kit with or without differential pressure gauge and eco series elements

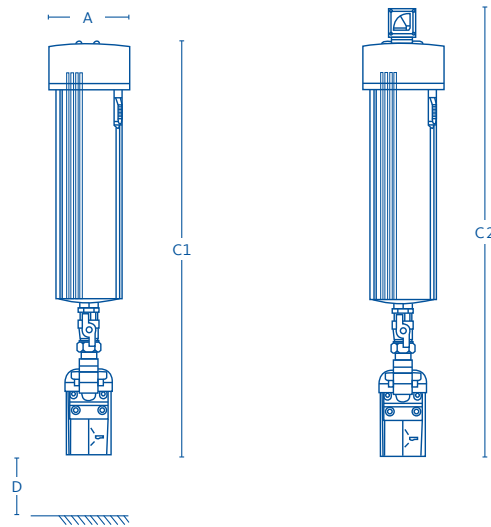

CLEARPOINT®	S040	S045	S050	S055	S075	S100	M010	M012	M015
Pipe Size (NPT)	¾"	½"	½"	½"	¾"	1"	1"	1"	1 ½"
Flow Rate (scfm)	25	30	50	80	100	125	160	200	250
Element Size	04*	04*	05*	06*	07*	07*	10*	12*	15*

Dimensions and Weight

A (inches)	2.95	2.95	2.95	2.95	3.94	3.94	3.94	3.94	5.75
C1 (inches)	15.55	15.55	16.73	18.90	19.49	19.49	22.24	23.62	22.83
C2 (inches)	18.11	18.11	19.29	21.46	22.05	22.05	24.80	26.18	25.39
D (inches)	5.91	5.91	5.91	5.91	5.91	5.91	5.91	5.91	6.30
Weight (lbs)	1.65	1.65	1.87	2.65	3.75	4.18	4.63	4.85	9.04

THREADED FILTER WITH BEKOMAT, WITHOUT GAUGE

Order ref. 25 µm	4047720	4047721	4023800	4047722	4047723	4020398	4006811	4020361	4047724
Price (\$)	\$416	\$437	\$474	\$522	\$571	\$600	\$630	\$658	\$906
Order ref. 1 µm	4047725	4047726	4003156	4047727	4045129	4020400	4003159	4047728	4003161
Price (\$)	\$416	\$437	\$474	\$522	\$571	\$600	\$630	\$658	\$906
Order ref. .01 µm	4047729	4047730	4003186	4047731	4003188	4020401	4003189	4003190	4003191
Price (\$)	\$416	\$437	\$474	\$522	\$571	\$600	\$630	\$658	\$906

THREADED FILTER WITH BEKOMAT, WITH GAUGE

Order ref. 25 µm	4041390	4020249	4047732	4047733	4019878	4020402	4047426	4047734	4014274
Price (\$)	\$483	\$506	\$542	\$590	\$636	\$690	\$734	\$759	\$974
Order ref. 1 µm	4014030	4020251	4017447	4034206	4014031	4020404	4014546	4015872	4016192
Price (\$)	\$483	\$506	\$542	\$590	\$636	\$690	\$734	\$759	\$974
Order ref. .01 µm	4004517	4020252	4047735	4019917	4014032	4020405	4014547	4015382	4014548
Price (\$)	\$483	\$506	\$542	\$590	\$636	\$690	\$734	\$759	\$974

Price Group 82

* ELEMENT GRADE	ELEMENT TYPE	MICRON RATING	OIL CARRYOVER	DRY Δ PRESSURE (psid)	WET Δ PRESSURE (psid)
Grade CX	Coarse	25 µm	5 mg/m ³	.44	.73
Grade FX	Fine	1 µm	.05 mg/m ³	.73	1.9
Grade SX	Superfine	.01 µm	.005 mg/m ³	.87	1.7

- › Advanced CLEARPOINT® eco series elements
- › Validated in accordance with ISO 12500-1 and 3
- › CRN approved
- › Filter for natural gas (CNG) on request
- › Max. operating pressure: 232 psig
- › Max. operating temperature: 140 °F

Maintenance Interval: < 8,000 hours
 Maintenance and Spare Parts: Page 27
 Extended Warranty: Page 144

CLEARPOINT®	M018	M019	M020	M022	M023	M025	M027	M030	M032
Pipe Size (NPT)	1 ½"	1 ½"	2"	2"	2"	2 ½"	2 ½"	3"	3"
Flow Rate (scfm)	330	450	500	600	800	1000	1300	1500	1900
Element Size	18*	20*	20*	22*	23*	25*	27*	30*	32*

Dimensions and Weight

A (inches)	5.75	5.75	5.75	5.75	5.75	10.24	10.24	10.24	10.24
C1 (inches)	24.92	26.89	26.89	30.71	35.35	34.88	38.98	39.76	49.61
C2 (inches)	27.48	29.45	29.45	33.27	37.91	37.44	41.54	42.32	52.17
D (inches)	6.30	6.30	6.30	6.30	6.30	7.87	7.87	7.87	7.87
Weight (lbs)	9.92	10.61	11.24	13.45	15.65	43.87	49.82	57.10	65.92

THREADED FILTER WITH BEKOMAT, WITHOUT GAUGE

Order ref. 25 µm	4047736	4047737	4047738	4047739	4047740	4047741	4047742	4047743	4047744
Price (\$)	\$954	\$1,103	\$1,137	\$1,262	\$1,587	\$2,317	\$2,449	\$2,646	\$3,076
Order ref. 1 µm	4015958	4047745	4003163	4015972	4046877	4021460	4047746	4023010	4023806
Price (\$)	\$954	\$1,103	\$1,137	\$1,262	\$1,587	\$2,317	\$2,449	\$2,646	\$3,076
Order ref. .01 µm	4047747	4047748	4003193	4003194	4003195	4003196	4047749	4003198	4047750
Price (\$)	\$954	\$1,103	\$1,137	\$1,262	\$1,587	\$2,317	\$2,449	\$2,646	\$3,076

THREADED FILTER WITH BEKOMAT, WITH GAUGE

Order ref. 25 µm	4047751	4047752	4047753	4024905	4047754	4047755	4047756	4010436	4047757
Price (\$)	\$1,025	\$1,181	\$1,268	\$1,433	\$1,645	\$2,387	\$2,516	\$2,715	\$3,143
Order ref. 1 µm	4014183	4020447	4006657	4019916	4020290	4014908	4047758	4010403	4021831
Price (\$)	\$1,025	\$1,181	\$1,268	\$1,433	\$1,645	\$2,387	\$2,516	\$2,715	\$3,143
Order ref. .01 µm	4013481	4020448	4015409	4020043	4047759	4020558	4047760	4007153	4021297
Price (\$)	\$1,025	\$1,181	\$1,268	\$1,433	\$1,645	\$2,387	\$2,516	\$2,715	\$3,143

Price Group 82

Correction Factors

Operating Pressure (psig)	20	40	60	80	90	100	110	120	130	140	160	180	200	230
Correction Factor	.30	.48	.65	.82	.91	1.00	1.09	1.17	1.26	1.35	1.52	1.70	1.87	2.13

The correction factors on this page provide an estimation of the performance that can be achieved with the model sizes shown. For precise sizing for your application, please contact your BEKO Technologies sales representative.

CLEARPOINT® Threaded Activated Carbon Filters

oil vapor removal filters with manual ball valve

- › With activated carbon filter element
- › Removal of solid particles up to .01 µm
- › Residual oil vapor content down to .003 mg/m³
- › CRN approved
- › Max. inlet moisture: 30% (dryer required upstream)
- › Max. operating pressure: 232 psig
- › Max. operating temperature: 140 °F

Maintenance Interval: < 300 hours
 Maintenance and Spare Parts: Page 27
 Extended Warranty: Page 144

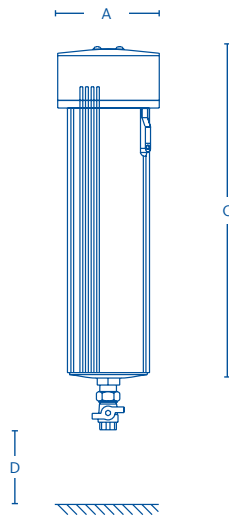

CLEARPOINT®	S040	S045	S050	S055	S075	S100	M010	M012	M015
Pipe Size (NPT)	3/8"	1/2"	1/2"	1/2"	3/4"	1"	1"	1"	1 1/2"
Flow Rate (scfm)	25	30	50	80	100	125	160	200	250
Element Size	04A	04A	05A	06A	07A	07A	10A	12A	15A

Dimensions and Weight

A (inches)	2.95	2.95	2.95	2.95	3.94	3.94	3.94	3.94	5.75
C (inches)	7.09	7.09	8.27	10.43	11.02	11.02	13.78	15.16	14.17
D (inches)	5.91	5.91	5.91	5.91	5.91	5.91	5.91	5.91	6.30
Weight (lbs)	1.65	1.65	1.87	2.65	3.75	4.18	4.63	4.85	9.04

THREADED ACTIVATED CARBON FILTER WITH MANUAL BALL VALVE

Order ref.	4002965	4024599	4002966	4002967	4002968	4023629	4002969	4002970	4002971
Price (\$)	\$234	\$250	\$278	\$328	\$374	\$409	\$427	\$494	\$702

CLEARPOINT®	M018	M019	M020	M022	M023	M025	M027	M030	M032
Pipe Size (NPT)	1 1/2"	1 1/2"	2"	2"	2"	2 1/2"	2 1/2"	3"	3"
Flow Rate (scfm)	330	450	500	600	800	1000	1300	1500	1900
Element Size	18A	20A	20A	22A	23A	25A	27A	30A	32A

Dimensions and Weight

A (in inches)	5.75	5.75	5.75	5.75	5.75	10.24	10.24	10.24	10.24
C1 (in inches)	16.46	16.46	18.43	22.24	26.89	26.42	30.51	35.24	41.14
D (in inches)	6.30	6.30	6.30	6.30	6.30	7.87	7.87	7.87	7.87
Weight (lbs)	9.92	10.61	11.24	13.45	15.65	43.87	49.82	57.10	65.92

THREADED ACTIVATED CARBON FILTER WITH MANUAL BALL VALVE

Order ref.	4002972	4026441	4002973	4002974	4002975	4002976	4002977	4002978	4002979
Price (\$)	\$778	\$906	\$972	\$1,082	\$1,184	\$2,109	\$2,195	\$2,394	\$2,823

Price Group 84

ELEMENT GRADE	ELEMENT TYPE	MICRON RATING	OIL CARRYOVER	Δ PRESSURE (psid)
Grade A	Activated Carbon Element	.01 µm	.003 mg/m ³	1.02

Correction Factors

Operating Pressure (psig)	20	40	60	80	90	100	110	120	130	140	160	180	200	230
Correction Factor	.30	.48	.65	.82	.91	1.00	1.09	1.17	1.26	1.35	1.52	1.70	1.87	2.13

The correction factors on this page provide an estimation of the performance that can be achieved with the model sizes shown. For precise sizing for your application, please contact your BEKO Technologies sales representative.

CLEARPOINT® Threaded Activated Carbon Cartridge Filters

oil vapor removal filters with manual ball valve

- › With activated carbon filter cartridge
- › Removal of solid particles up to 1 µm
- › Residual oil vapor content down to .003 mg/m³
- › CRN approved
- › Max. inlet moisture: 30% (dryer required upstream)
- › Max. operating pressure: 232 psig
- › Max. operating temperature: 140 °F

Maintenance Interval: < 1,000 hours
 Maintenance and Spare Parts: Page 27
 Extended Warranty: Page 144

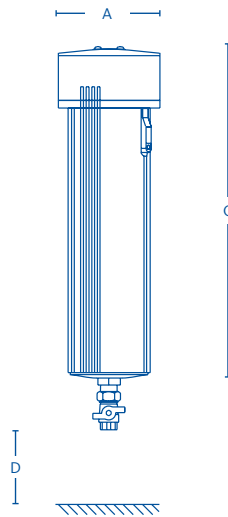

CLEARPOINT®	S055	M010	M018
Pipe Size (NPT)	½"	1"	1 ½"
Flow Rate (scfm)	29	59	118
Cartridge Size	06V	10V	18V
Dimensions and Weight			
A (inches)	2.95	3.94	5.75
C (inches)	10.43	13.78	16.46
D (inches)	5.91	5.91	6.30
Weight (lbs)	2.65	4.63	9.92

THREADED ACTIVATED CARBON CARTRIDGE FILTER WITH MANUAL BALL VALVE

Order ref.	4013174	4047761	4017502
Price (\$)	\$555	\$889	\$1,440

Price Group 84

ELEMENT GRADE	ELEMENT TYPE	MICRON RATING	OIL CARRYOVER	Δ PRESSURE (psid)
Grade V	Activated Carbon Cartridge	1 µm	.003 mg/m ³	.54

Correction Factors

Operating Pressure (psig)	20	40	60	80	90	100	110	120	130	140	160	180	200	230
Correction Factor	.30	.48	.65	.82	.91	1.00	1.09	1.17	1.26	1.35	1.52	1.70	1.87	2.13

The correction factors on this page provide an estimation of the performance that can be achieved with the model sizes shown. For precise sizing for your application, please contact your BEKO Technologies sales representative.

CLEARPOINT® Flanged Water Separators

with BEKOMAT® and connection kit

- › Removal of large quantities of condensate
- › Used downstream of aftercoolers
- › BEKOMAT® drain as standard
- › Designed according to ASME Sec. VIII, Div. 1
- › UM stamp standard and CRN optional
- › Max. operating pressure: 232 psig
- › Max. operating temperature: 140 °F

Maintenance Interval: < 8,000 hours

Maintenance and Spare Parts: Page 27

Extended Warranty: Page 144

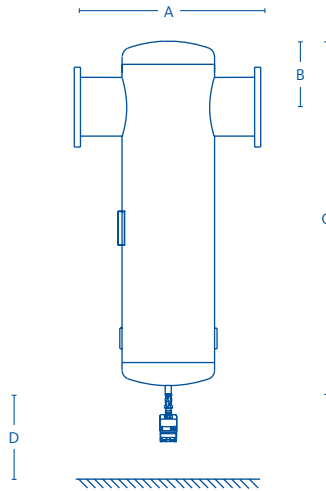

CLEARPOINT®	L100	L102	L150	L156	L200	L204	L254	L304
Pipe Size (ANSI)	4"	4"	6"	6"	8"	8"	10"	12"
Flow Rate (scfm)	1900	2800	3800	6500	7500	9300	13000	21000
Separator Size	88W							

Dimensions and Weight

A (inches)	15.75	18.75	19.10	21.13	22.81	24.80	29.53	34.25
B (inches)	6.96	7.75	7.80	9.75	12.38	11.34	13.07	14.57
C (inches)	34.25	37.25	50.24	52.63	64.50	66.93	81.50	95.28
D (inches)	12.40	18.90	18.90	18.50	18.31	17.72	17.72	16.93
Weight (lbs)	150	230	294	350	500	562	653	741

FLANGED WATER SEPARATORS WITH BEKOMAT

Order ref.	4033071	4033072	4047762	4047763	4047764	4047765	4047766	4047767
Price (\$)	\$4,976	\$6,292	\$7,381	\$8,306	\$10,332	\$11,231	\$15,394	\$16,833

Price Group 80

ELEMENT GRADE	ELEMENT TYPE	DRY Δ PRESSURE (psid)	REMOVAL RATE
Grade W	Water Separator	.87	99.0%

Correction Factors

Operating Pressure (psig)	20	40	60	80	90	100	110	120	130	140	160	180	200	230
Correction Factor	.30	.48	.65	.82	.91	1.00	1.09	1.17	1.26	1.35	1.52	1.70	1.87	2.13

The correction factors on this page provide an estimation of the performance that can be achieved with the model sizes shown. For precise sizing for your application, please contact your BEKO Technologies sales representative.

CLEARPOINT® Flanged Coalescing and Particulate Filters

with BEKOMAT® and connection kit with differential pressure gauge

- › Advanced CLEARPOINT® eco series elements
- › Validated in accordance with ISO 12500
- › Designed according to ASME Sec. VIII, Div. 1
- › UM stamp standard and CRN optional
- › Max. operating pressure: 232 psig
- › Max. operating temperature: 140 °F

Maintenance Interval: < 8,000 hours
 Maintenance and Spare Parts: Page 28
 Extended Warranty: Page 144

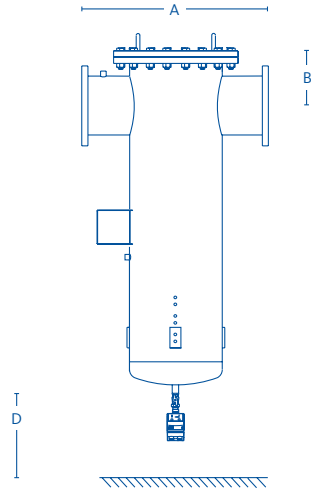

CLEARPOINT®	L100	L102	L150	L156	L200	L204	L254	L304
Pipe Size (ANSI)	4"	4"	6"	6"	8"	8"	10"	12"
Flow Rate (scfm)	1900	2800	3800	6500	7500	9300	13000	21000
Element Size	88*							

Dimensions and Weight

	L100	L102	L150	L156	L200	L204	L254	L304
A (inches)	21.25	21.25	23.50	23.75	28.00	30.31	34.65	38.98
B (inches)	6.88	7.13	8.00	8.25	9.50	9.75	9.88	10.87
C (inches)	46.50	47.38	46.88	50.38	53.00	56.34	60.18	64.26
D (inches)	13.00	18.00	18.00	18.00	18.00	18.00	18.00	18.00
Weight (lbs)	195	266	283	328	534	623	727	825

FLANGED FILTER WITH BEKOMAT, WITH GAUGE

Order ref. 25 µm	4047768	4047769	4047770	4047771	4046762	4046765	4047772	4047773
Price (\$)	\$6,315	\$7,865	\$9,408	\$11,613	\$14,155	\$15,920	\$21,942	\$26,737
Order ref. 1 µm	4020749	4020761	4020864	4020874	4057036	4037501	4047774	4047775
Price (\$)	\$6,315	\$7,865	\$9,408	\$11,613	\$14,155	\$15,920	\$21,942	\$26,737
Order ref. .01 µm	4020750	4020762	4020865	4047776	4041302	4046764	4047777	4047778
Price (\$)	\$6,315	\$7,865	\$9,408	\$11,613	\$14,155	\$15,920	\$21,942	\$26,737

FLANGED ACTIVATED CARBON FILTER WITH MANUAL BALL VALVE, WITHOUT GAUGE

Order ref. Activated Carbon	4020751	4020763	4020866	4047779	4046763	4046766	4047780	4047781
Price (\$)	\$5,877	\$7,410	\$8,950	\$11,155	\$13,698	\$15,463	\$21,942	\$26,280

Price Group 80

* ELEMENT GRADE	ELEMENT TYPE	MICRON RATING	OIL CARRYOVER	OIL VAPOR	DRY Δ PRESSURE (psid)	WET Δ PRESSURE (psid)	APPROVALS
Grade CX	Coarse	25 µm	5 mg/m ³	-	.44	.73	ASME Coded Vessel with UM Stamp as standard (CRN Optional)
Grade FX	Fine	1 µm	.05 mg/m ³	-	.73	1.9	
Grade SX	Superfine	.01 µm	.005 mg/m ³	-	.87	1.7	
Grade A	Activated Carbon	.01 µm	-	.003 mg/m ³	1.45	-	

Correction Factors

Operating Pressure (psig)	20	40	60	80	90	100	110	120	130	140	160	180	200
Correction Factor	.30	.48	.65	.82	.91	1.00	1.09	1.17	1.26	1.35	1.52	1.70	1.87

The correction factors on this page provide an estimation of the performance that can be achieved with the model sizes shown. For precise sizing for your application, please contact your BEKO Technologies sales representative.

CLEARPOINT® V Activated Carbon Adsorption Towers

in-line oil vapor removal towers with activated carbon fill

- › Filled with activated carbon adsorbent
- › Required pre-filtration: .01 µm
- › Residual oil vapor content down to .003 mg/m³
- › Max. inlet moisture: 30% (dryer required upstream)
- › Max. operating pressure: 150 psig
- › Max. operating temperature: 120 °F

Maintenance Interval: < 8,000 hours

Maintenance and Spare Parts: Page 27

Extended Warranty: Page 144

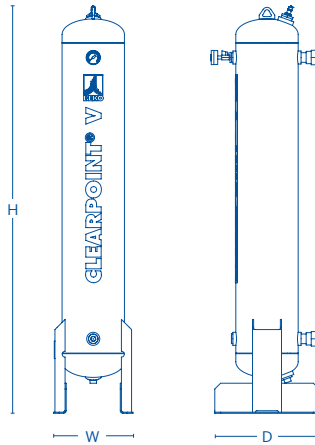

CLEARPOINT® V	V80	V100	V120	V160	V200	V250	V300	V400	V500
Pipe Size (NPT)	1"	1"	1"	1½"	1½"	1½"	1½"	2"	2"
Flow Rate (scfm)	80	100	120	160	200	250	300	400	500
Dimensions and Weight									
H x W x D (inches)	58 x 11 x 17	70 x 11 x 17	70 x 11 x 17	70 x 14 x 19	70 x 14 x 19	77 x 16 x 23	77 x 16 x 23	68 x 17 x 24	78 x 19 x 26
Empty Weight (lbs)	190	190	196	224	260	273	312	356	427
Total Fill (lbs)	24	30	35	48	60	75	90	120	152

ACTIVATED CARBON ADSORPTION TOWER (FILTRATION REQUIRED)

Order ref.	4034705	4034706	4034707	4034708	4034709	4034710	4034711	4034712	4034713
Price (\$)	\$3,170	\$3,752	\$3,881	\$4,270	\$4,787	\$5,046	\$5,305	\$6,468	\$7,115

Price Group 84

REQUIRED FILTERS, NOT MOUNTED

	S100	M015	M018	M020
Pre-Filter .01 µm	4020388	4003405	4014542	4003406
Price (\$)	\$492	\$769	\$836	\$983

Price Group 82

CLEARPOINT® V	V650	V800	V1000	V1200	V1500	V1900	V2300	V2800
Pipe Size	2½"	2½"	2½" Flange	2½" Flange	3" Flange	3" Flange	4" Flange	4" Flange
Flow Rate (scfm)	650	800	1000	1200	1500	1900	2300	2800
Dimensions and Weight								
H x W x D (inches)	74 x 22 x 29	72 x 24 x 31	85 x 24 x 26	84 x 26 x 27	90 x 28 x 29	77 x 35 x 35	93 x 35 x 35	83 x 40 x 41
Empty Weight (lbs)	583	609	734	872	1,380	1,737	2,168	2,360
Total Fill (lbs)	199	246	286	344	430	544	659	802

ACTIVATED CARBON ADSORPTION TOWER (FILTRATION REQUIRED)

Order ref.	4034714	4034715	4034716	4034717	4034718	4034719	4034720	4034721
Price (\$)	\$7,365	\$9,225	\$11,637	\$12,001	\$14,479	\$16,185	\$18,248	\$19,804

Price Group 84

REQUIRED FILTERS, NOT MOUNTED

	M025	M027	M030	L102
Pre-Filter .01 µm	4021904	4025162	4022499	4020762
Price (\$)	\$2,180	\$2,265	\$2,462	\$7,865

Price Group 82

Correction Factors

Operating Pressure (psig)	60	70	80	90	100	110	120	130	140	150
Correction Factor	.65	.74	.83	.91	1.00	1.12	1.16	1.2	1.25	1.29

CLEARPOINT® H Threaded Compressed Air Heaters

in-line compressed air heater with user adjustable temperature

- › For the adjustable heating of compressed air
- › Adjustable temperature from 86 °F to 140 °F
- › Includes line cord 8.2 ft(2.5m) with US-plug
- › Encapsulated corrosion-free stainless-steel heating cartridges
- › Available touch protection option
- › Max. operating pressure: 232 psig

No Maintenance Required
Extended Warranty: Page 144

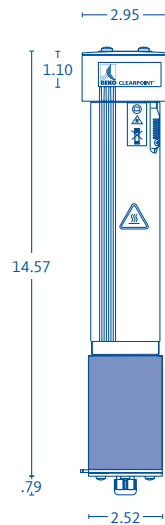

CLEARPOINT® H	S040	S050
Pipe Size (NPT)	3/8"	1/2"
Max. Volume Flow at 100 psig	30 scfm	60 scfm
Compressed Air Outlet Temperature Adjustment Range (°F)	86 °F to 140 °F	86 °F to 140 °F
Max. Operating Pressure (psig)	232	232
Pressure Differential	< 2.18 psig	< 2.90 psig
Voltage	115 VAC / 60 Hz +/-10%	115 VAC / 60 Hz +/-10%
Inlet Temperature Range (°F)	36 °F to 122 °F	36 °F to 122 °F
Ambient Temperature Range (°F)	36 °F to 122 °F	36 °F to 122 °F
Internal Safety Auto-off Temperature (°F)	183 °F	183 °F
Max. Housing Temperature (°F)	176 °F	176 °F
Max. Compressed Air Outlet Temperature (°F)	140 °F	140 °F
Max. Power Consumption	750	750
Volume (l)	0.42	0.42
Weight (lbs)	5.3	5.3
Protection Class	IP 54	IP 54

THREADED COMPRESSED AIR HEATER

Order ref.	4029051	4012743
Price (\$)	\$1,823	\$1,935

Price Group 84

CLEARPOINT® PN50 Threaded High Pressure Water Separators

with open port or with BEKOMAT® connection kit (drain sold separately) without pressure gauge

- › Removal of large quantities of condensate
- › Used downstream of aftercooler
- › Max. operating temperature: 140 °F
- › Max. operating pressure: 725 psig

Maintenance Interval: < 8,000 hours
 Maintenance and Spare Parts: Page 27
 Extended Warranty: Page 144

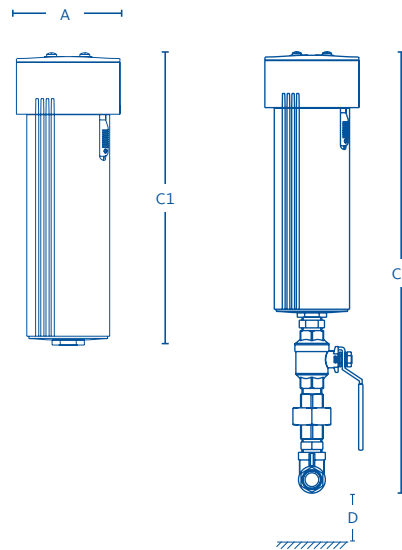

CLEARPOINT® PN50	HP50S040	HP50S050	HP50S075	HP50M010	HP50M015	HP50M020
Pipe Size (NPT)	3/8"	1/2"	3/4"	1"	1 1/2"	2"
Flow Rate (scfm)	100	190	440	600	1000	1720
Separator Size	04W	05W	07W	10W	15W	20W

Dimensions and Weight

A (inches)	2.95	2.95	3.95	3.95	5.75	5.75
C1 (inches)	7.10	8.30	11.00	13.80	14.40	18.40
C2 (inches)	16.50	16.50	20.50	23.20	23.80	27.80
D (inches)	7.10	7.10	7.10	7.10	7.10	7.10
Weight (lbs)	1.65	1.85	3.75	4.63	9.04	11.24

THREADED HIGH PRESSURE WATER SEPARATOR WITH OPEN PORT

Order ref.	4025277	4044760	4020962	4034366	4041616	4026603
Price (\$)	\$419	\$538	\$842	\$1,042	\$1,310	\$1,765

THREADED HIGH PRESSURE WATER SEPARATOR WITH DRAIN CONNECTION KIT

Order ref.	4012590	4014556	4014435	4032180	4033059	4015959
Price (\$)	\$615	\$698	\$1,024	\$1,205	\$1,463	\$1,984

Price Group 82

OPTIONAL DRAIN

BEKOMAT® 12 CO PN63	2002931
Price (\$)	\$1,215

Price Group 10

ELEMENT GRADE	ELEMENT TYPE	Δ PRESSURE (psid)	REMOVAL RATE
Grade W	Water Separator	.87	99.0%

Correction Factors

Operating Pressure (psig)	60	90	100	150	200	300	450	600	725
Correction Factor	.14	.18	.24	.35	.43	.59	.73	.88	1.00

The correction factors on this page provide an estimation of the performance that can be achieved with the model sizes shown. For precise sizing for your application, please contact your BEKO Technologies sales representative.

CLEARPOINT® PN50 Threaded Coalescing and Particulate High Pressure Filters

with open port without pressure gauge

- › Advanced CLEARPOINT® eco series elements
- › Validated in accordance with ISO 12500-1 and 3
- › Max. operating temperature: 140 °F
- › Max. operating pressure: 725 psig

Maintenance Interval: < 8,000 hours
 Maintenance and Spare Parts: Page 27
 Extended Warranty: Page 144

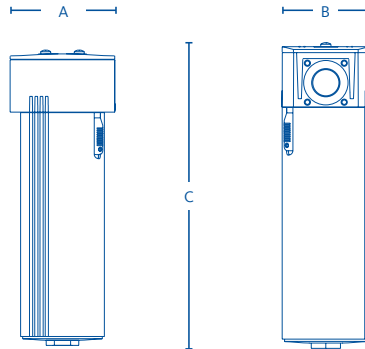

CLEARPOINT® PN50	HP50S040	HP50S050	HP50S055	HP50S075	HP50M010	HP50M012	HP50M015	HP50M018	HP50M020	HP50M022	HP50M023
Pipe Size	3/8"	1/2"	1/2"	3/4"	1"	1"	1 1/2"	1 1/2"	2"	2"	2"
Flow Rate (scfm)	100	190	300	440	600	710	1000	1210	1720	2065	2750
Element Size	04*	05*	06*	07*	10*	12*	15*	18*	20*	22*	23*

Dimensions and Weight

A (inches)	2.36	2.36	2.36	3.15	3.15	3.15	4.72	4.72	4.72	4.72	4.72
B (inches)	2.95	2.95	2.95	3.95	3.95	3.95	5.75	5.75	5.75	5.75	5.75
C (inches)	7.10	8.30	10.40	11.00	13.80	15.20	14.40	16.50	18.40	22.20	26.90
Weight (lbs)	1.65	1.85	2.65	3.75	4.63	4.85	9.04	9.92	11.24	13.45	15.65

THREADED HIGH PRESSURE FILTER WITH OPEN PORT, WITHOUT GAUGE

Order ref. 25 µm	4011170	4020143	4025582	4010824	4047782	4047783	4011137	4047784	4011135	4047785	4047786
Price (\$)	\$428	\$570	\$665	\$879	\$1,042	\$1,193	\$1,333	\$1,569	\$1,855	\$2,008	\$2,202
Order ref. 1 µm	4011169	4009817	4009830	4010826	4033252	4011477	4047787	4047788	4029879	4047789	4047790
Price (\$)	\$428	\$570	\$665	\$879	\$1,042	\$1,193	\$1,333	\$1,569	\$1,855	\$2,008	\$2,202
Order ref. .01 µm	4025278	4020144	4014624	4024031	4047791	4047792	4011133	4047793	4011134	4047794	4047795
Price (\$)	\$428	\$570	\$665	\$879	\$1,042	\$1,193	\$1,333	\$1,569	\$1,855	\$2,008	\$2,202

Price Group 82

* ELEMENT GRADE	ELEMENT TYPE	MICRON RATING	OIL CARRYOVER	OIL VAPOR	DRY Δ PRESSURE (psid)
Grade CX	Coarse	25 µm	5 mg/m ³	-	.54
Grade FX	Fine	1 µm	.05 mg/m ³	-	.86
Grade SX	Superfine	.01 µm	.005 mg/m ³	-	1.04
Grade A	Activated Carbon	.01 µm	-	.003 mg/m ³	.70

Correction Factors

Operating Pressure (psig)	60	90	100	150	200	300	450	600	725
Correction Factor	.14	.18	.24	.35	.43	.59	.73	.88	1.00

The correction factors on this page provide an estimation of the performance that can be achieved with the model sizes shown. For precise sizing for your application, please contact your BEKO Technologies sales representative.

CLEARPOINT® PN50 Threaded Coalescing and Particulate High Pressure Filters

with BEKOMAT® connection kit (drain sold separately) without pressure gauge

- › Advanced CLEARPOINT® eco series elements
- › Validated in accordance with ISO 12500-1 and 3
- › Shown with BEKOMAT® 12 CO PN 63 (optional)
- › Filter for natural gas (CNG) on request
- › Max. operating temperature: 140 °F
- › Max. operating pressure: 725 psig

Maintenance Interval: < 8,000 hours

Maintenance and Spare Parts: Page 27

Extended Warranty: Page 144

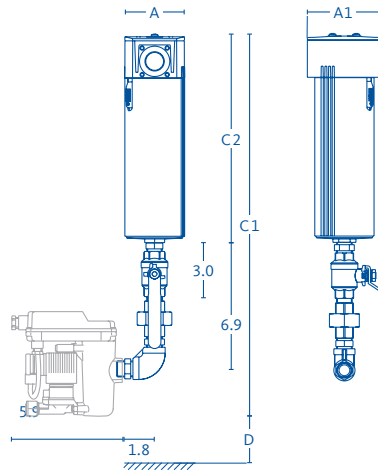

CLEARPOINT® PN50	HP50S040	HP50S050	HP50S055	HP50S075	HP50M010	HP50M012	HP50M015	HP50M018	HP50M020	HP50M022	HP50M023
Pipe Size	3/8"	1/2"	1/2"	3/4"	1"	1"	1 1/2"	1 1/2"	2"	2"	2"
Flow Rate (scfm)	100	190	300	440	600	710	1000	1210	1720	2065	2750
Element Size	04*	05*	06*	07*	10*	12*	15*	18*	20*	22*	23*

Dimensions and Weight

A (inches)	2.95	2.95	2.95	3.95	3.95	3.95	5.75	5.75	5.75	5.75	5.75
A1 (inches)	2.36	2.36	2.36	3.15	3.15	3.15	4.72	4.72	4.72	4.72	4.72
C1 (inches)	16.50	16.50	19.90	20.50	23.20	24.60	23.80	25.90	27.80	31.60	36.30
C2 (inches)	7.10	8.30	10.40	11.00	13.80	15.20	14.40	16.50	18.40	22.20	26.90
D (inches)	7.10	7.10	7.10	7.10	7.10	7.10	7.10	7.10	7.10	7.10	7.10
Weight (lbs)	1.65	1.85	2.65	3.75	4.63	4.85	9.04	9.92	11.24	13.45	15.65

THREADED HIGH PRESSURE FILTER WITH DRAIN CONNECTION KIT, WITHOUT GAUGE

Order ref. 25 µm	4012593	4047796	4047797	4047798	4047799	4047800	4047801	4047802	4047803	4047804	4047805
Price (\$)	\$615	\$725	\$815	\$1,020	\$1,170	\$1,393	\$1,463	\$1,641	\$1,984	\$2,180	\$2,372
Order ref. 1 µm	4020169	4029877	4047806	4037961	4032540	4047807	4017646	4047808	4015401	4047809	4045235
Price (\$)	\$615	\$725	\$815	\$1,020	\$1,170	\$1,393	\$1,463	\$1,641	\$1,984	\$2,180	\$2,372
Order ref. .01 µm	4012594	4029878	4039185	4047810	4032539	4047811	4017647	4047812	4037533	4047813	4047814
Price (\$)	\$615	\$725	\$815	\$1,020	\$1,170	\$1,393	\$1,463	\$1,641	\$1,984	\$2,180	\$2,372

Price Group 82

OPTIONAL DRAIN

BEKOMAT® 12 CO PN63	2002931
Price (\$)	\$1,215

Price Group 10

* ELEMENT GRADE	ELEMENT TYPE	MICRON RATING	OIL CARRYOVER	OIL VAPOR	DRY Δ PRESSURE (psid)
Grade CX	Coarse	25 µm	5 mg/m ³	-	.54
Grade FX	Fine	1 µm	.05 mg/m ³	-	.86
Grade SX	Superfine	.01 µm	.005 mg/m ³	-	1.04
Grade A	Activated Carbon	.01 µm	-	.003 mg/m ³	.70

Correction Factors

Operating Pressure (psig)	60	90	100	150	200	300	450	600	725
Correction Factor	.14	.18	.24	.35	.43	.59	.73	.88	1.00

The correction factors on this page provide an estimation of the performance that can be achieved with the model sizes shown. For precise sizing for your application, please contact your BEKO Technologies sales representative.

CLEARPOINT® PN50 Threaded Activated Carbon High Pressure Filters

oil vapor removal filters with manual ball valve

- › With activated carbon filter element
- › Removal of solid particles up to .01 µm
- › Residual oil vapor content down to .003 mg/m³
- › Max. inlet moisture: 30% (dryer required upstream)
- › Max. operating pressure: 725 psig
- › Max. operating temperature: 140 °F

Maintenance Interval: 300 hours
 Maintenance and Spare Parts: Page 27
 Extended Warranty: Page 144

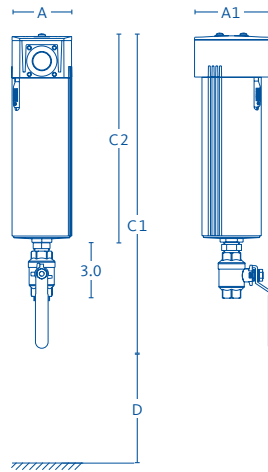

CLEARPOINT® PN50	HP50S040	HP50S050	HP50S055	HP50S075	HP50M010	HP50M012	HP50M015	HP50M018	HP50M020	HP50M022	HP50M023
Pipe Size	3/8"	1/2"	1/2"	3/4"	1"	1"	1 1/2"	1 1/2"	2"	2"	2"
Flow Rate (scfm)	100	190	300	440	600	710	1000	1210	1720	2065	2750
Element Size	04A	05A	06A	07A	10A	12A	15A	18A	20A	22A	23A

Dimensions and Weight

A (inches)	2.95	2.95	2.95	3.95	3.95	3.95	5.75	5.75	5.75	5.75	5.75
A1 (inches)	2.36	2.36	2.36	3.15	3.15	3.15	4.72	4.72	4.72	4.72	4.72
C1 (inches)	16.50	16.50	19.90	20.50	23.20	24.60	23.80	25.90	27.80	31.60	36.30
C2 (inches)	7.10	8.30	10.40	11.00	13.80	15.20	14.40	16.50	18.40	22.20	26.90
D (inches)	7.10	7.10	7.10	7.10	7.10	7.10	7.10	7.10	7.10	7.10	7.10
Weight (lbs)	1.65	1.85	2.65	3.75	4.63	4.85	9.04	9.92	11.24	13.45	15.65

THREADED HIGH PRESSURE ACTIVATED CARBON FILTER WITH MANUAL BALL VALVE

Order ref.	4022651	4037829	4025580	4031610	4042507	4047815	4047816	4047817	4015633	4047818	4047819
Price (\$)	\$615	\$725	\$815	\$1,020	\$1,170	\$1,393	\$1,463	\$1,641	\$1,984	\$2,180	\$2,372

Price Group 82

ELEMENT GRADE	ELEMENT TYPE	MICRON RATING	OIL CARRYOVER	OIL VAPOR	DRY Δ PRESSURE (psid)
Grade A	Activated Carbon	.01 µm	-	.003 mg/m ³	.70

Correction Factors

Operating Pressure (psig)	60	90	100	150	200	300	450	600	725
Correction Factor	.14	.18	.24	.35	.43	.59	.73	.88	1.00

The correction factors on this page provide an estimation of the performance that can be achieved with the model sizes shown. For precise sizing for your application, please contact your BEKO Technologies sales representative.

CLEARPOINT® HP High Pressure Filters

with open port without pressure gauge

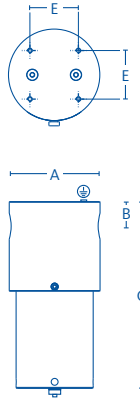

CLEARPOINT® HP 100	HP100S040	HP100S045	HP100S050	HP100S055	HP100S075	HP100M010	HP100M015	HP100M020
Max. Operating Pressure (psig)	1,450	1,450	1,450	1,450	1,450	1,450	1,450	1,450
Pipe Size (NPT)	3/8"	3/8"	1/2"	1/2"	3/4"	1"	1 1/2"	2"
Flow Rate (scfm)	25	60	160	270	400	700	1000	2000

HIGH PRESSURE FILTER WITH OPEN PORT, WITHOUT GAUGE

Order ref.	HP100S040 ...WC	HP100S045 ...WC	HP100S050 ...WC	HP100S055 ...WC	HP100S075 ...WC	HP100M010 ...WC	HP100M015 ...WC	HP100M020 ...WC
Price (\$)	\$1,380	\$1,518	\$1,854	\$2,392	\$3,228	\$4,588	\$7,312	\$8,571

... Choose one CX / FX / SX / A and insert element grade to Order ref. number. See chart below*.

CLEARPOINT® HP 350	HP350S030	HP350S040	HP350S045	HP350S050	HP350S075	HP350M010	HP350M012	HP350M015
Max. Operating Pressure (psig)	5,075	5,075	5,075	5,075	5,075	5,075	5,075	5,075
Pipe Size (NPT)	1/4"	3/8"	3/8"	1/2"	3/4"	1"	1"	1 1/2"
Flow Rate (scfm)	30	75	205	350	520	920	1300	2600

HIGH PRESSURE FILTER WITH OPEN PORT, WITHOUT GAUGE

Order ref.	HP350S030 ...WC	HP350S040 ...WC	HP350S045 ...WC	HP350S050 ...WC	HP350S075 ...WC	HP350M010 ...WC	HP350M012 ...WC	HP350M015 ...WC
Price (\$)	\$2,146	\$2,320	\$2,900	\$3,154	\$5,422	\$6,798	\$9,137	\$11,343

... Choose one CX / FX / SX / A and insert element grade to Order ref. number. See chart below*.

CLEARPOINT® HP 500	HP500S030	HP500S040	HP500S045	HP500S050
Max. Operating Pressure (psig)	7,250	7,205	7,250	7,250
Pipe Size (NPT)	1/4"	3/8"	3/8"	1/2"
Flow Rate (scfm)	30	80	220	380

HIGH PRESSURE FILTER WITH OPEN PORT, WITHOUT GAUGE

Order ref.	HP500S030 ...WC	HP500S040 ...WC	HP500S045 ...WC	HP500S050 ...WC
Price (\$)	\$2,573	\$2,801	\$3,482	\$3,808

... Choose one CX / FX / SX / A and insert element grade to Order ref. number. See chart below*.

OPTIONAL ACCESSORIES

Needle Valve for HP 100 / 350	4016153
Price (\$)	\$376
Needle Valve for HP 500	4038134
Price (\$)	\$2,329

Price Group 81

* ELEMENT GRADE	ELEMENT TYPE	MICRON RATING	OIL CARRYOVER	OIL VAPOR	DRY Δ PRESSURE (psid)
Grade CX	Coarse	25 µm	10 mg/m ³	-	.54
Grade FX	Fine	1 µm	.1 mg/m ³	-	.86
Grade SX	Superfine	.01 µm	.01 mg/m ³	-	1.04
Grade A	Activated Carbon	-	-	.003 mg/m ³	.70

- › Stainless steel housing
- › Max. operating temperature: 140 °F (HP350S075 and HP350M010 only)
- › Max. operating temperature: 248 °F (all other models)
- › Max. inlet pressure: 1,450 - 7,250 psig

Maintenance Interval: < 8,000 hours
 Maintenance and Spare Parts: Page 28
 Extended Warranty: Page 144

CLEARPOINT® HP	A	B	C	E	Volume (gal)	Weight (lbs)
HP100S040	2.36	.65	4.61	0.98	0.01	4.41
HP100S045	3.11	.81	5.51	1.39	0.03	9.92
HP100S050	3.07	.91	8.43	1.57	0.10	8.82
HP100S055	3.07	.91	10.39	1.57	0.13	12.13
HP100S075	4.49	1.16	10.63	2.36	0.32	23.15
HP100M010	4.49	1.16	16.54	2.36	0.52	30.20
HP100M015	6.85	1.97	18.94	3.94	0.87	74.96
HP100M020	6.85	1.97	30.87	3.94	1.51	92.60
HP350S030	2.36	0.65	4.61	0.98	0.01	4.41
HP350S040	3.11	0.81	5.51	1.39	0.03	9.92
HP350S045	3.46	0.91	8.43	1.57	0.10	14.33
HP350S050	3.46	0.91	10.39	1.57	0.13	16.53
HP350S075	5.47	1.47	11.26	3.15	0.30	45.19
HP350M010	5.47	1.47	17.17	3.15	0.52	59.52
HP350M012	6.65	1.94	18.90	3.15	0.85	99.23
HP350M015	6.65	1.94	30.83	3.15	1.51	156.53
HP500S030	2.36	0.65	4.61	0.98	0.01	4.41
HP500S040	3.11	0.81	5.51	1.39	0.03	9.92
HP500S045	4.45	0.98	8.70	2.36	0.10	26.46
HP500S050	4.45	0.98	10.67	2.36	0.13	28.66

Correction Factors

Operating Pressure (1,450 psig)	300	450	600	725	900	1,100	1,200	1,300	1,450
Correction Factor	.45	.56	.64	.71	.78	.84	.90	.95	1.00

Operating Pressure (5,075 psig)	3,000	3,600	4,500	5,075
Correction Factor	.84	.89	.94	1.00

Operating Pressure (7,250 psig)	4,500	5,000	5,800	6,500	7,250
Correction Factor	.89	.93	.96	.98	1.00

The correction factors on this page provide an estimation of the performance that can be achieved with the model sizes shown. For precise sizing for your application, please contact your BEKO Technologies sales representative.

CLEARPOINT® Accessories

oil check indicator



	Complete Oil Check Indicator Set	Mounting Adapter for Oil Check Indicator			
Fits CLEARPOINT® Models	S055V, M010V and M018V	S040 - S055	S075-M012	M015-M023	M025-M032
Order ref.	4008728	4008713	4008725	4008726	4008749
Price (\$)	\$460	\$85	\$88	\$92	\$112
Oil Check Indicator					
Order ref.	-	4025989			
Price (\$)	-	\$398			

Price Group 84

wall brackets

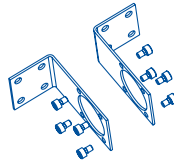

	FMBK4	FMBK5	FMBK6	FMBK7
Fits Filter Housing	S040 S045 S050 S055	S075 S100 M010 M012	M015 M018 M019 M020 M022 M023	M025 M027 M030 M032
Order ref.	4003328	4003329	4003330	4003331
Price (\$)	\$71	\$81	\$95	\$104

Price Group 84

modular connection kits

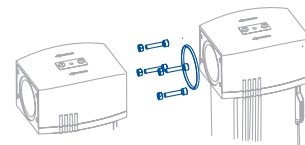
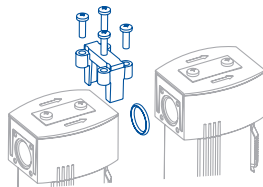

	F2CK4	F2CK5	F2CK6	F2CK7
Fits Filter Housing	S040 S045 S050 S055	S075 S100 M010 M012	M015 M018 M019 M020 M022 M023	M025 M027 M030 M032
Order ref.	4003332	4003333	4003334	4003335
Price (\$)	\$54	\$72	\$52	\$62

Price Group 84

CLEARPOINT® Maintenance

- replacement filter elements for standard and PN50 series threaded filters

Maintenance Interval: < 8,000 hours

Filter Housing	CX 25 µm	FX 1 µm	SX .01 µm	A* .003 ppm	Price (\$)
S040 / S045 / HP50S040	4038157	4038104	4038111	4002737	\$88
S050 / HP50S050	4038158	4038139	4038148	4002738	\$113
S055 / HP50S055	4038159	4038105	4038112	4002739	\$134
S075 / S100 / HP50S075	4038160	4038106	4038113	4002740	\$142
M010 / HP50M010	4038161	4038140	4038149	4002741	\$169
M012 / HP50M012	4038162	4038107	4038114	4002742	\$217
M015 / HP50M015	4038163	4038108	4038115	4002743	\$235
M018 / HP50M018	4038164	4038141	4038150	4002744	\$271
M019 / M020 / HP50M020	4038165	4038142	4038151	4002745	\$323
M022	4038166	4038143	4038152	4002746	\$358
M023	4038167	4038144	4038153	4002747	\$417
M025	4038168	4038109	4038116	4002748	\$453
M027	4038169	4038145	4038154	4002749	\$511
M030	4038177	4038146	4038155	4002750	\$760
M032	4038170	4038147	4038156	4002751	\$855

* A filter grade element maintenance interval: <300 hours

Price Group 86

CLEARPOINT® V Maintenance

- filling material for activated carbon adsorption towers

Maintenance Interval: 8,000 hours

Replacement Activated Carbon (30 lb bags)		
4mm diameter		
All models and fill weights	4056165	\$528 ea.

Price Group 63

- replacement filter cartridges for CLEARPOINT® V series

Maintenance Interval: < 1,000 hours

Filter Housing	V .003 ppm	Price (\$)
S055	4009180	\$353
M010	4009181	\$541
M018	4009182	\$798

Price Group 84

CLEARPOINT® Maintenance

■ replacement filter elements for flanged filters

Maintenance Interval: < 8,000 hours

Filter Housing	88CX 25 µm	88FX 1 µm	88SX .01 µm	88A .003 ppm	Order Quantity	Price (\$)	Flat Gasket for Top Lid	Price (\$)
L100	4038178	4038110	4038117	4021586	2	\$846	4032958	\$15
L102	4038178	4038110	4038117	4021586	3	\$1,269	4032959	\$42
L150	4038178	4038110	4038117	4021586	4	\$1,692	4032959	\$42
L156	4038178	4038110	4038117	4021586	7	\$2,961	4032960	\$63
L200	4038178	4038110	4038117	4021586	8	\$3,384	4032961	\$85
L204	4038178	4038110	4038117	4021586	10	\$4,230	4032962	\$134
L254	4038178	4038110	4038117	4021586	14	\$5,922	4032963	\$209
L304	4038178	4038110	4038117	4021586	22	\$9,306	4032964	\$330

Price Group 86 Price Group 63

■ replacement filter elements for HP series filters

Maintenance Interval: < 8,000 hours

Filter Housing	CX 25 µm	FX 1 µm	SX .01 µm	A .003 ppm	Price (\$)
HP100S040	4007820	4007822	4007823	4007824	\$307
HP100S045	4007827	4007829	4007830	4007831	\$396
HP100S050	4007835	4007839	4007841	4007843	\$497
HP100S055	4007836	4007840	4007842	4007844	\$585
HP100S075	4007849	4007853	4007855	4007857	\$654
HP100M010	4007850	4007854	4007856	4007858	\$756
HP100M015	4007863	4007867	4007869	4007871	\$833
HP100M020	4007864	4007868	4007870	4007872	\$1,130
HP350S030	4007820	4007822	4007823	4007824	\$307
HP350S040	4007827	4007829	4007830	4007831	\$396
HP350S045	4007835	4007839	4007841	4007843	\$497
HP350S050	4007836	4007840	4007842	4007844	\$585
HP350S075	4007849	4007853	4007855	4007857	\$654
HP350M010	4007850	4007854	4007856	4007858	\$756
HP350M012	4007863	4007867	4007869	4007871	\$833
HP350M015	4007864	4007868	4007870	4007872	\$1,130
HP500S030	4007820	4007822	4007823	4007824	\$307
HP500S040	4007827	4007829	4007830	4007831	\$396
HP500S045	4007835	4007839	4007841	4007843	\$497
HP500S050	4007836	4007840	4007842	4007844	\$585

Price Group 84

CLEARPOINT® Maintenance

■ replacement float drains

Maintenance Interval: < 8,000 hours



CLEARPOINT S040-M032 from Aug. 2004 / max. pressure 232 psig	
Order ref.	4025536
Price (\$)	\$96

Price Group 84

■ service unit for BEKOMAT® drains

Maintenance Interval: < 8,000 hours

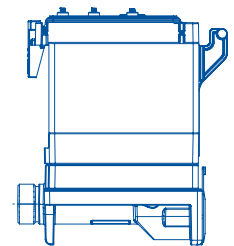
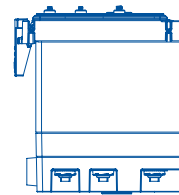
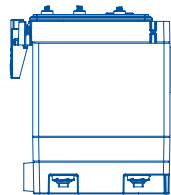

Fits BEKOMAT® Model	31	32	32 V	33
	For S040-M025 filters S040-S100 water separators	For M027-M032 filters	For M010-M030 water separators L100-L304 filter and water separators	-
Order ref.	4023608	4025061	4023573	4023634
Price (\$)	\$141	\$167	\$186	\$219

Price Group 12

■ oil check indicator detector tube

Maintenance Interval: after every use



Replacement detector tube with needle valve for CLEARPOINT® V	
Order ref.	4025989
Price (\$)	\$398

Price Group 84

CLEARPOINT® Spare Parts

■ replacement o-ring sets for standard and PN50 series threaded units

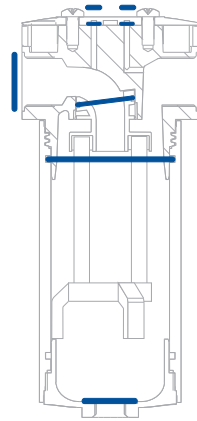

	S040 S045 S050 S055	S075 S100 M010 M012	M015 M018 M019 M020 M022 M023	M025 M027 M030 M032
Filter Housing	and HP50 housing equivalents	and HP50 housing equivalents	and HP50 housing equivalents	and HP50 housing equivalents
Order ref.	4026562	4026563	4026564	4026565
Price (\$)	\$44	\$49	\$55	\$60

Price Group 86

■ replacement lock bar (slide) kits

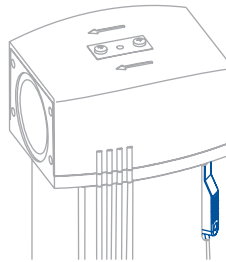

Includes the slide (red lock bar), screw, flat disc, rubber seal, and Viton o-ring

Filter Housing	S040 - M012	M015 - M032
Order ref.	4008541	4008540
Price (\$)	\$41	\$55

Price Group 86

■ replacement differential pressure gauges

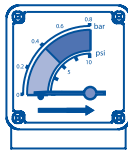

For direct mounting on the filter
for S040 - M032 / L100 - 304

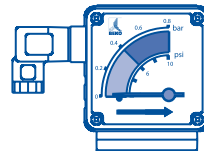

With the potential-free contact
for S040 - M032 / L100 - 304

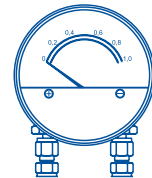

For direct mounting on HP series filters
(max. 5,075 psig)

Differential Pressure Gauges			
Max. Pressure (psig)	232	232	5,075
Order ref.	4010931	4001481	4009202
Price (\$)	\$110	\$233	\$1,687

Price Group 84

CLEARPOINT® Spare Parts

■ connection kit with ball valve

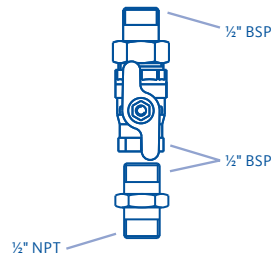

1/2" connection kit with ball valve for S040-M032 L100-L304	
Max. Pressure (psig)	232
Order ref.	2002228
Price (\$)	\$68

Price Group 84

■ replacement BEKOMAT® drains

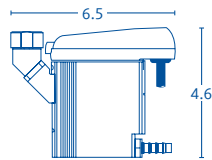

For S040-M025 filters
S040-S100 water separators

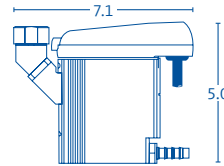

For M027-M032 filters

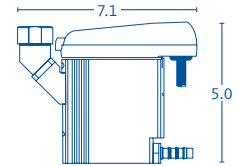

For M010-M030 water separators
L100-L304 filter and water separators

	BEKOMAT 31	BEKOMAT 32	BEKOMAT 32V
Max. Pressure (psig)	232	232	232
Order ref.	4025098	4025088	4025091
Price (\$)	\$250	\$339	\$320

Price Group 12

Refrigerant Drying



DRYPOINT® RA

the most economical way to dry compressed air

- › RAc economy series, compact refrigerant air dryers
- › RAX fully equipped, premium refrigerant air dryers
- › RA CT & VSD cycling and variable speed refrigerant air dryers
- › RA HT high inlet temperature refrigerant air dryers
- › RS HP high inlet pressure refrigerant air dryers, and more...

DRYPOINT® RAc Economy Refrigeration Dryers

economically priced with BEKOMAT® or with timer drain in a compact frame

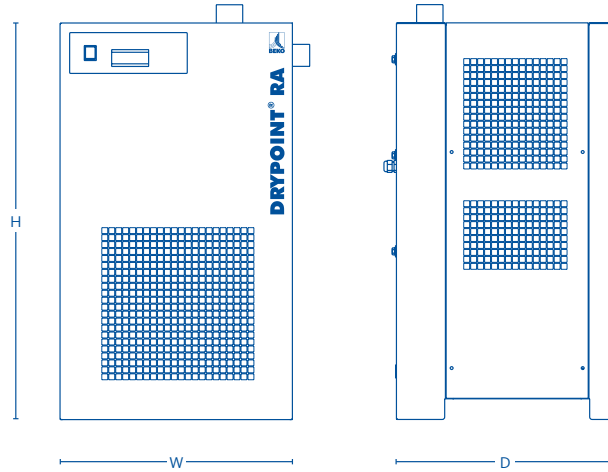

DRYPOINT® RAc	RAc 10	RAc 15	RAc 20	RAc 35	RAc 50	RAc 75	RAc 100
Connection Size (NPT)	½"	½"	½"	½"	½"	1"	1¼"
Flow Rate (scfm)	10	15	20	35	50	75	100
Operating Voltage	115 V / 1 Ph	115 V / 1 Ph	115 V / 1 Ph	115 V / 1 Ph	115 V / 1 Ph	115 V / 1 Ph	115 V / 1 Ph
Power Consumption - Load (kW)	.19	.20	.21	.29	.30	.45	.70

Dimensions and Weight

H x W x D (inches)	19 x 15 x 20	19 x 15 x 20	19 x 15 x 20	19 x 15 x 20	19 x 15 x 20	29 x 14 x 17	29 x 14 x 18
Weight (lbs)	57	60	62	62	68	84	86

REFRIGERANT DRYER WITH BEKOMAT® DRAIN

ECO CHOICE

Order ref.	4050435	4050436	4050437	4050438	4050439	4050440	4050441
Price (\$)	\$1,642	\$1,730	\$1,856	\$1,982	\$2,370	\$2,685	\$3,366

REFRIGERANT DRYER WITH TIMER DRAIN

Order ref.	4050383	4050422	4050423	4050424	4050425	4050426	4050427
Price (\$)	\$1,437	\$1,537	\$1,730	\$1,840	\$2,062	\$2,354	\$2,923

Price Group 51

REQUIRED 1 µm PRE-FILTRATION

	S040	S045	S050	S055	S100
without Δpsi gauge Float Drain	4002890	4020220	4002891	4002892	4020305
Price (\$)	\$234	\$250	\$278	\$328	\$409
with Δpsi gauge BEKOMAT®	4014030	4020251	4017447	4034206	4020404
Price (\$)	\$483	\$506	\$542	\$590	\$690

Price Group 82

OPTIONAL .01 µm POST-FILTRATION

without Δpsi gauge Float Drain	4002950	4020231	4002951	4002952	4020384
Price (\$)	\$234	\$250	\$278	\$328	\$409

Price Group 82

OPTIONAL EQUIPMENT

Three-Valve Bypass*	4040646		4032965	4032966	4032967
Price (\$)	\$461		\$502	\$625	\$798

Price Group 53

*The bypass will be dry fit to unit and shipped loose to prevent damage, filtration is not included. Filters ordered with bypass are also shipped loose.

- › Required pre-filtration: 1 µm | Recommended post-filtration: .01 µm
- › UL / CSA certified
- › Outlet pressure dew point: Class 4-5 in accordance with ISO 8573-1:2010
- › Max. inlet air temperature: 130 °F
- › Min. / max. ambient temperature: 34 °F / 115 °F
- › Max. inlet pressure: RAc 10 - 50: 232 psig | RAc 75 - 480: 200 psig

Maintenance Interval: < 8,000 hours
 Maintenance and Spare Parts: Page 50
 Extended Warranty: Page 144

DRYPOINT® RAc	RAc 125	RAc 150	RAc 175	RAc 220	RAc 300	RAc 375	RAc 480
Connection Size (NPT)	1¼"	1¼"	1½"	1½"	2"	2"	2½"
Flow Rate (scfm)	125	150	175	220	300	375	480
Operating Voltage	115 V / 1 Ph	115 V / 1 Ph	230 V / 1 Ph	230 V / 1 Ph	230 V / 1 Ph	230 V / 1 Ph	230 V / 1 Ph
Power Consumption - Load (kW)	1.00	1.05	1.20	1.25	1.50	2.20	2.30
Dimensions and Weight							
H x W x D (inches)	29 x 14 x 18	32 x 19 x 18	35 x 22 x 23	35 x 22 x 23	38 x 22 x 25	38 x 22 x 25	44 x 26 x 29
Weight (lbs)	88	90	119	123	207	212	317

REFRIGERANT DRYER WITH BEKOMAT® DRAIN

ECO CHOICE

Order ref.	4050442	4050443	4050444	4050445	4050446	4050447	4050448
Price (\$)	\$3,568	\$3,866	\$4,655	\$4,975	\$7,136	\$7,818	\$9,977

REFRIGERANT DRYER WITH TIMER DRAIN

Order ref.	4050428	4050429	4050430	4050431	4050432	4050433	4050434
Price (\$)	\$3,394	\$3,694	\$4,478	\$4,798	\$6,958	\$7,492	\$9,650

Price Group 51

**REQUIRED 1 µm
PRE-FILTRATION**

	S100	M010	M015	M020
without Δpsi gauge Float Drain	4020305	4002894	4002896	4002898
Price (\$)	\$409	\$427	\$702	\$972
with Δpsi gauge BEKOMAT®	4020404	4014546	4016192	4006657
Price (\$)	\$690	\$734	\$974	\$1,268

Price Group 82

**OPTIONAL .01 µm
POST-FILTRATION**

without Δpsi gauge Float Drain	4020384	4002954	4002956	4002958
Price (\$)	\$409	\$427	\$702	\$972

Price Group 82

OPTIONAL EQUIPMENT

Three-Valve Bypass*	4032967	4032968	4032969	4032970
Price (\$)	\$798	\$962	\$1,460	\$2,795

Price Group 53

Correction Factors

Operating Pressure psig	60	80	100	120	140	160	180	200
Correction Factor	.79	.91	1.00	1.07	1.13	1.18	1.23	1.27

Ambient Air Temperature °F	80	90	100	110	115
Correction Factor	1.10	1.07	1.00	.83	.70

Inlet Air Temperature °F	90	100	110	120	130
Correction Factor	1.11	1.00	.80	.65	.53

DRYPOINT® RAx Premium Refrigeration Dryers

equipped with all premium features including BEKOMAT® as standard

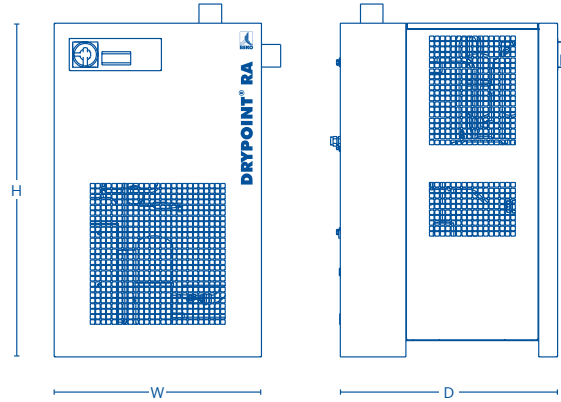

DRYPOINT® RAx	RAx 20	RAx 30	RAx 50	RAx 75	RAx 100	RAx 125
Connection Size (NPT)	½"	½"	½"	1"	1¼"	1¼"
Flow Rate (scfm)	20	30	50	75	100	125
Power Consumption - Load (kW)	.26	.27	.39	.48	.58	1.00
Dimensions and Weight						
H x W x D (inches)	29 x 14 x 17	29 x 14 x 17	29 x 14 x 17	29 x 14 x 17	32 x 19 x 18	32 x 19 x 18
Weight (lbs)	64	68	75	79	82	101

REFRIGERANT DRYER WITH STANDARD VOLTAGE

Voltage	115 V / 1 Ph	115 V / 1 Ph	115 V / 1 Ph	115 V / 1 Ph	115 V / 1 Ph	115 V / 1 Ph
Order ref.	4028689	4028691	4028693	4028695	4028697	4028699
Price (\$)	\$2,160	\$2,437	\$2,610	\$3,075	\$3,931	\$4,076

REFRIGERANT DRYER WITH OPTIONAL VOLTAGE

Voltage	230 V / 1 Ph	230 V / 1 Ph	230 V / 1 Ph	230 V / 1 Ph	230 V / 1 Ph	230 V / 1 Ph
Order ref.	4019934	4019936	4019938	4019940	4019942	4028700
Price (\$)	\$2,160	\$2,437	\$2,610	\$3,075	\$3,931	\$4,076

Price Group 51

REQUIRED 1 µm PRE-FILTRATION

	S045	S050	S100
without Δpsi gauge Float Drain	4020220	4002891	4020305
Price (\$)	\$250	\$278	\$409
with Δpsi gauge BEKOMAT®	4020251	4017447	4020404
Price (\$)	\$506	\$542	\$690

Price Group 82

OPTIONAL .01 µm POST-FILTRATION

without Δpsi gauge Float Drain	4020231	4002951	4020384
Price (\$)	\$250	\$278	\$409

Price Group 82

OPTIONAL EQUIPMENT

Anti-Corrosion Option TAC	Factory installed option - please add TAC suffix to order reference number (Example: 40xxxxx-TAC)		
Price (\$)	\$374		\$496
Three-Valve Bypass*	4031472	4032245	4032246
Price (\$)	\$502	\$625	\$798

Price Group 53

*The bypass will be dry fit to unit and shipped loose to prevent damage, filtration is not included. Filters ordered with bypass are also shipped loose.

- › Required pre-filtration: 1 µm | Recommended post-filtration: .01 µm
- › RAx 20-200 115V UL / CSA certified
- › RAx 125-400 230V UL / CSA certified
- › RAx 200-500 460V UL / CSA control panel
- › Outlet pressure dew point: Class 4-5 in accordance with ISO 8573-1:2010
- › Max. inlet air temperature: 160 °F
- › Min. / max. ambient temperature: 34 °F / 120 °F
- › Max. inlet pressure: RAx 20-50: 232 psig | RAx 75-500: 200 psig

Maintenance Interval: < 8,000 hours
 Maintenance and Spare Parts: Page 50
 Extended Warranty: Page 144

DRYPOINT® RAx	RAx 150	RAx 200	RAx 250	RAx 300	RAx 350	RAx 400	RAx 500
Connection Size (NPT)	1¼"	1½"	1½"	2"	2"	2½"	2½"
Flow Rate (scfm)	150	200	250	300	350	400	500
Power Consumption - Load (kW)	1.05	1.10	1.39	1.64	2.19	2.48	2.97
Dimensions and Weight							
H x W x D (inches)	32 x 19 x 18	35 x 22 x 23	35 x 22 x 23	38 x 22 x 25	38 x 22 x 25	44 x 26 x 29	44 x 26 x 29
Weight (lbs)	110	121	139	203	207	331	355

REFRIGERANT DRYER WITH STANDARD VOLTAGE

Voltage	115 V / 1 Ph	115 V / 1 Ph	230 V / 1 Ph	230 V / 1 Ph	230 V / 1 Ph	230 V / 1 Ph	460 V / 3 Ph
Order ref.	4028701	4028703	4028706	4028708	4028710	4028712	4028714
Price (\$)	\$4,446	\$5,559	\$6,447	\$8,014	\$8,742	\$10,366	\$12,106

REFRIGERANT DRYER WITH OPTIONAL VOLTAGE

Voltage	230 V / 1 Ph	230 V / 1 Ph	460 V / 3 Ph	460 V / 3 Ph	460 V / 3 Ph	460 V / 3 Ph	-
Order ref.	4028702	4028704	4028707	4028709	4028711	4028713	-
Price (\$)	\$4,446	\$5,559	\$7,662	\$8,793	\$9,289	\$11,047	-
Voltage	-	460 V / 3 Ph	-	-	-	-	-
Order ref.	-	4028705	-	-	-	-	-
Price (\$)	-	\$7,130	-	-	-	-	-

Price Group 51

REQUIRED 1 µm PRE-FILTRATION

	M010	M015	M020	M025
without Δpsi gauge Float Drain	4002894	4002896	4002898	4002901
Price (\$)	\$427	\$702	\$972	\$2,109
with Δpsi gauge BEKOMAT®	4014546	4016192	4006657	4014908
Price (\$)	\$734	\$974	\$1,268	\$2,387

Price Group 82

OPTIONAL .01 µm POST-FILTRATION

without Δpsi gauge Float Drain	4002954	4002956	4002958	4002961
Price (\$)	\$427	\$702	\$972	\$2,109

Price Group 82

OPTIONAL EQUIPMENT

Anti-Corrosion Option TAC	Factory installed option - please add TAC suffix to order reference number (Example: 40xxxxx-TAC)						
Price (\$)	\$496	\$611			\$1,226		
Water Ingress Protection IP54	Factory installed option - please add IP54 suffix to order reference number (Example: 40xxxxx-IP54)						
Price (\$)	\$741					\$806	
Three-Valve Bypass*	4032246	4031899	4032247	4032248			
Price (\$)	\$798	\$962	\$1,460	\$2,795			

Price Group 53

Correction Factors

Operating Pressure psig	60	80	100	120	140	160	180	200
Correction Factor	.79	.91	1.00	1.07	1.13	1.18	1.23	1.27

Ambient Air Temperature °F	80	90	100	105	110	115	120
Correction Factor	1.11	1.09	1.00	.94	.87	.78	.69

Inlet Air Temperature °F	90	100	110	120	130	140	150	160
Correction Factor	1.16	1.00	.82	.68	.61	.52	.45	.40

The correction factors on this page provide an estimation of the performance that can be achieved with the model sizes shown. For precise sizing for your application, please contact your BEKO Technologies sales representative.

DRYPOINT® RAx Premium Refrigeration Dryers

equipped with all premium features including BEKOMAT® as standard

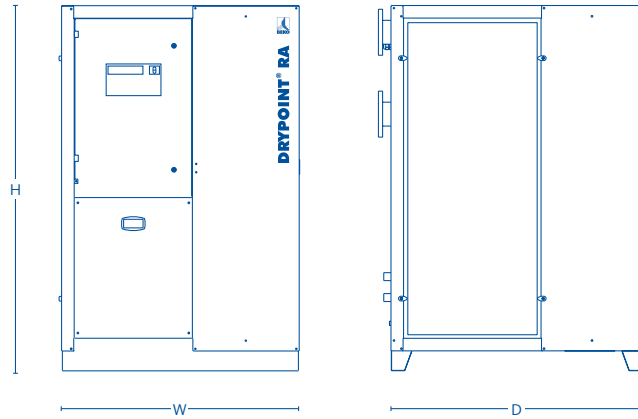

DRYPOINT® RAx	RAx 600	RAx 800	RAx 1000	RAx 1250	RAx 1500	RAx 1750	RAx 2000	RAx 2500
Connection Size (ANSI)	3" Flange	3" Flange	3" Flange	3" Flange	4" Flange	4" Flange	4" Flange	4" Flange
Flow Rate (scfm)	600	800	1000	1250	1500	1750	2000	2500
Power Consumption - Load (kW)	2.65	3.25	4.60	5.60	6.40	7.50	8.60	9.80

Dimensions and Weight

H x W x D (inches)	58 x 31 x 39	58 x 31 x 39	58 x 31 x 39	58 x 31 x 39	69 x 45 x 47	69 x 45 x 47	69 x 45 x 47	69 x 45 x 47
Weight (lbs)	529	534	608	686	1,021	1,186	1,190	1,349

AIR COOLED REFRIGERANT DRYER WITH STANDARD VOLTAGE

Voltage	460 V / 3 Ph	460 V / 3 Ph	460 V / 3 Ph	460 V / 3 Ph	460 V / 3 Ph	460 V / 3 Ph	460 V / 3 Ph	460 V / 3 Ph
Order ref.	4028715	4028717	4028719	4028721	4028723	4028725	4028727	4028729
Price (\$)	\$14,836	\$16,312	\$18,632	\$23,700	\$29,184	\$32,051	\$35,919	\$42,019

Price Group 51

WATER COOLED REFRIGERANT DRYER WITH STANDARD VOLTAGE

Voltage	460 V / 3 Ph	460 V / 3 Ph	460 V / 3 Ph	460 V / 3 Ph	460 V / 3 Ph	460 V / 3 Ph	460 V / 3 Ph	460 V / 3 Ph
Order ref.	4043474	4043475	4043476	4043477	4043478	4043479	4043480	4043481
Price (\$)	\$16,357	\$16,746	\$19,065	\$23,700	\$29,184	\$32,282	\$35,919	\$42,019

Price Group 51

REQUIRED 1 µm PRE-FILTRATION

	M030	L100	L102
without Δpsi gauge Float Drain	4002903	-	-
Price (\$)	\$2,394	-	-
with Δpsi gauge BEKOMAT®	4010403	4020749	4020761
Price (\$)	\$2,715	\$6,315	\$7,865

Price Group 82

OPTIONAL .01 µm POST-FILTRATION

without Δpsi gauge Float Drain	4002963	4020750	4020762
Price (\$)	\$2,394	\$6,315	\$7,865

Price Group 82

OPTIONAL EQUIPMENT

Anti-Corrosion Option TAC	Factory installed option - please add TAC suffix to order reference number (Example: 40xxxxx-TAC)		
Price (\$)	\$1,511	\$2,473	
Sea Water Cooled Variant SWC	Add SWC suffix to order reference number (Example: 40xxxxx-SWC)		
Price (\$)	ON REQUEST		
Water Ingress Protection IP54	Factory installed option - please add IP54 suffix to order reference number (Example: 40xxxxx-IP54)		
Price (\$)	\$806		
PC Connection Kit	4039183		
Price (\$)	\$1,071		
Three-Valve Bypass*	4032249	4039182	
Price (\$)	\$3,888	\$3,926	

Price Group 53

*The bypass will be dry fit to unit and shipped loose to prevent damage, filtration is not included. Filters ordered with bypass are also shipped loose.

- › Required pre-filtration: 1 µm | Recommended post-filtration: .01 µm
- › UL / CSA certified control panel
- › MODBUS ready
- › Outlet pressure dew point: Class 4-5 in accordance with ISO 8573-1:2010
- › Max. inlet air temperature: 160 °F
- › Min. / max. ambient temperature: 34 °F / 120 °F
- › Max. inlet pressure: RAx 600-10000: 200 psig

Maintenance Interval: < 8,000 hours
 Maintenance and Spare Parts: Page 50
 Extended Warranty: Page 144

DRYPOINT® RAx	RAx 3000	RAx 4000	RAx 5000	RAx 6000	RAx 7500	RAx8000	RAx10000
Connection Size (ANSI)	6" Flange	8" Flange	8" Flange	8" Flange	8" Flange	10" Flange	10" Flange
Flow Rate (scfm)	3000	4000	5000	6000	7500	8000	10000
Power Consumption - Load (kW)	12.20	15.70	23.50	25.50	27.10	35.00	40.70
Dimensions and Weight							
H x W x D (inches)	71 x 51 x 69	74 x 55 x 87	74 x 55 x 87	96 x 61 x 85	96 x 61 x 85	96 x 61 x 107	96 x 61 x 107
Weight (lbs)	1,830	2,330	2,650	3,640	4,030	4,730	5,390

AIR COOLED REFRIGERANT DRYER WITH STANDARD VOLTAGE

Voltage	460 V / 3 Ph	460 V / 3 Ph	460 V / 3 Ph	460 V / 3 Ph	460 V / 3 Ph	460 V / 3 Ph	460 V / 3 Ph
Order ref.	4028731	4028733	4028735	4031468	4031470	4038789	4038793
Price (\$)	\$52,401	\$69,720	\$91,551	\$108,706	\$127,720	\$134,849	\$183,843

Price Group 51

WATER COOLED REFRIGERANT DRYER WITH STANDARD VOLTAGE

Voltage	460 V / 3 Ph	460 V / 3 Ph	460 V / 3 Ph	460 V / 3 Ph	460 V / 3 Ph	460 V / 3 Ph	460 V / 3 Ph
Order ref.	4043482	4043483	4043484	4043485	4043486	4043487	4043488
Price (\$)	\$52,401	\$69,720	\$91,551	\$108,706	\$127,720	\$134,849	\$183,843

Price Group 51

REQUIRED 1 µm PRE-FILTRATION

	L150	L200	L204	L254
without Δpsi gauge Float Drain	-	-	-	-
Price (\$)	-	-	-	-
with Δpsi gauge BEKOMAT®	4020864	4057036	4037501	4047774
Price (\$)	\$9,408	\$14,155	\$15,920	\$21,942

Price Group 82

OPTIONAL .01 µm POST-FILTRATION

without Δpsi gauge Float Drain	4020865	4041302	4046764	4047777
Price (\$)	\$9,408	\$14,155	\$15,920	\$21,942

Price Group 82

OPTIONAL EQUIPMENT

Anti-Corrosion Option TAC	Factory installed option - please add TAC suffix to order reference number (Example: 40xxxxx-TAC)						
Price (\$)	\$3,708	\$4,945	\$6,736				
Sea Water Cooled Variant SWC	Add SWC suffix to order reference number (Example: 40xxxxx-SWC)						
Price (\$)	ON REQUEST						
Water Ingress Protection IP54	Factory installed option - please add IP54 suffix to order reference number (Example: 40xxxxx-IP54)						
Price (\$)	\$806						
PC Connection Kit	4039183						
Price (\$)	\$1,071						

Price Group 53

Correction Factors

Operating Pressure psig	60	80	100	120	140	160	180	200
Correction Factor	.79	.91	1.00	1.07	1.13	1.18	1.23	1.27

Ambient Air Temperature °F	80	90	100	105	110	115	120
Correction Factor	1.11	1.09	1.00	.94	.87	.78	.69

Inlet Air Temperature °F	90	100	110	120	130	140	150	160
Correction Factor	1.16	1.00	.82	.68	.61	.52	.45	.40

DRYPOINT® RA CT Series Refrigeration Dryers

ultra efficient dryers with cycling technology and standard BEKOMAT®

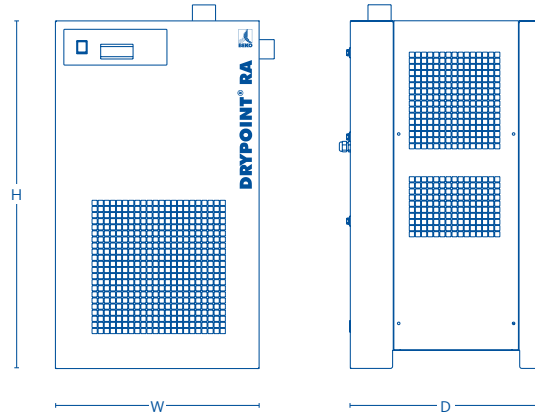

DRYPOINT® RA CT	RACT 20	RACT 30	RACT 50	RACT 75	RACT 100	RACT 125	RACT 150
Connection Size (NPT)	½"	½"	½"	1"	1¼"	1¼"	1¼"
Flow Rate (scfm)	20	30	50	75	100	125	150
Power Consumption at Full Load (kW)	.26	.27	.39	.48	.58	1.00	1.05
Dimensions and Weight							
H x W x D (inches)	29 x 14 x 17	29 x 14 x 17	29 x 14 x 17	29 x 14 x 17	32 x 19 x 18	32 x 19 x 18	32 x 19 x 18
Weight (lbs)	64	68	75	79	82	101	110

REFRIGERANT DRYER WITH STANDARD VOLTAGE

Voltage	115 V / 1 Ph	115 V / 1 Ph	115 V / 1 Ph	115 V / 1 Ph	115 V / 1 Ph	115 V / 1 Ph	115 V / 1 Ph
Order ref.	4038907	4038908	4038909	4038910	4038911	4038912	4038913
Price (\$)	\$2,537	\$2,810	\$3,072	\$3,579	\$4,445	\$5,304	\$5,765

REFRIGERANT DRYER WITH OPTIONAL VOLTAGE

Voltage	-	-	-	-	-	230 V / 1 Ph	230 V / 1 Ph
Order ref.	-	-	-	-	-	4038915	4038916
Price (\$)	-	-	-	-	-	\$5,304	\$5,765

Price Group 51

REQUIRED 1 µm PRE-FILTRATION

	S045	S050	S100	M010
without Δpsi gauge Float Drain	4020220	4002891	4020305	4002894
Price (\$)	\$250	\$278	\$409	\$427
with Δpsi gauge BEKOMAT®	4020251	4017447	4020404	4014546
Price (\$)	\$506	\$542	\$690	\$734

Price Group 82

OPTIONAL .01 µm POST-FILTRATION

without Δpsi gauge Float Drain	4020231	4002951	4020384	4002954
Price (\$)	\$250	\$278	\$409	\$427

Price Group 82

OPTIONAL EQUIPMENT

Anti-Corrosion Option TAC	Factory installed option - please add TAC suffix to order reference number (Example: 40xxxxx-TAC)		
Price (\$)	\$374		\$496
Water Ingress Protection IP54	Factory installed option - please add IP54 suffix to order reference number (Example: 40xxxxx-IP54)		
115 V / 230 V Price (\$)	-		\$976
460 V Price (\$)	-		\$806
Three-Valve Bypass*	4031472	4032245	4032246
Price (\$)	\$502	\$625	\$798

Price Group 53

*The bypass will be dry fit to unit and shipped loose to prevent damage, filtration is not included. Filters ordered with bypass are also shipped loose.

- › Required pre-filtration: 1 µm | Recommended post-filtration: .01 µm
- › UL/CSA certified: RA CT 20-200: 115V | RA CT 250-500: 230V
- › UL/CSA certified control panel: RA CT 200-500: 460V
- › Outlet pressure dew point: Class 4-5 in accordance with ISO 8573-1:2010
- › Max. inlet air temperature: 160 °F
- › Min. / max. ambient temperature: 34 °F / 120 °F
- › Max. inlet pressure: RA CT 20-50: 232 psig | RA CT 75-500: 200 psig

Maintenance Interval: < 8,000 hours
 Maintenance and Spare Parts: Page 50
 Extended Warranty: Page 144

DRYPOINT® RA CT	RACT 200	RACT 250	RACT 300	RACT 350	RACT 400	RACT 500
Connection Size (NPT)	1½"	1½"	2"	2"	2½"	2½"
Flow Rate (scfm)	200	250	300	350	400	500
Power Consumption at Full Load (kW)	1.10	1.39	1.64	2.19	2.48	2.97
Dimensions and Weight						
H x W x D (inches)	35 x 22 x 23	35 x 22 x 23	38 x 22 x 25	38 x 22 x 25	44 x 26 x 29	44 x 26 x 29
Weight (lbs)	121	139	203	207	331	355

REFRIGERANT DRYER WITH STANDARD VOLTAGE

Voltage	115 V / 1 Ph	230 V / 1 Ph	230 V / 1 Ph	230 V / 1 Ph	230 V / 1 Ph	230 V / 1 Ph
Order ref.	4038914	4038918	4038919	4038920	4038921	4038922
Price (\$)	\$6,710	\$7,632	\$9,471	\$10,193	\$11,067	\$12,729

REFRIGERANT DRYER WITH OPTIONAL VOLTAGE

Voltage	460 V / 3 Ph	460 V / 3 Ph	460 V / 3 Ph	460 V / 3 Ph	460 V / 3 Ph	460 V / 3 Ph
Order ref.	4045287	4045288	4045289	4045290	4045291	4045292
Price (\$)	\$7,677	\$8,394	\$10,245	\$11,304	\$11,594	\$13,936

Price Group 51

REQUIRED 1 µm PRE-FILTRATION

	M015	M020	M025
without Δpsi gauge Float Drain	4002896	4002898	4002901
Price (\$)	\$702	\$972	\$2,109
with Δpsi gauge BEKOMAT®	4016192	4006657	4014908
Price (\$)	\$974	\$1,268	\$2,387

Price Group 82

OPTIONAL .01 µm POST-FILTRATION

without Δpsi gauge Float Drain	4002956	4002958	4002961
Price (\$)	\$702	\$972	\$2,109

Price Group 82

OPTIONAL EQUIPMENT

Anti-Corrosion Option TAC	Factory installed option - please add TAC suffix to order reference number (Example: 40xxxxx-TAC)					
Price (\$)	\$611					\$1,226
Water Ingress Protection IP54	Factory installed option - please add IP54 suffix to order reference number (Example: 40xxxxx-IP54)					
115 V / 230 V Price (\$)	\$976					
460 V Price (\$)	\$806					
Three-Valve Bypass*	4031899	4032247				4032248
Price (\$)	\$962	\$1,460				\$2,795

Price Group 53

Correction Factors

Operating Pressure psig	60	80	100	120	140	160	180	200
Correction Factor	.79	.91	1.00	1.07	1.13	1.18	1.23	1.27

Ambient Air Temperature °F	80	90	100	105	110	115	120
Correction Factor	1.11	1.09	1.00	.94	.87	.78	.69

Inlet Air Temperature °F	90	100	110	120	130	140	150	160
Correction Factor	1.16	1.00	.82	.68	.61	.52	.45	.40

The correction factors on this page provide an estimation of the performance that can be achieved with the model sizes shown. For precise sizing for your application, please contact your BEKO Technologies sales representative.

DRYPOINT® RA VSD Series Refrigeration Dryers

ultra efficient dryers with variable speed technology and standard BEKOMAT®

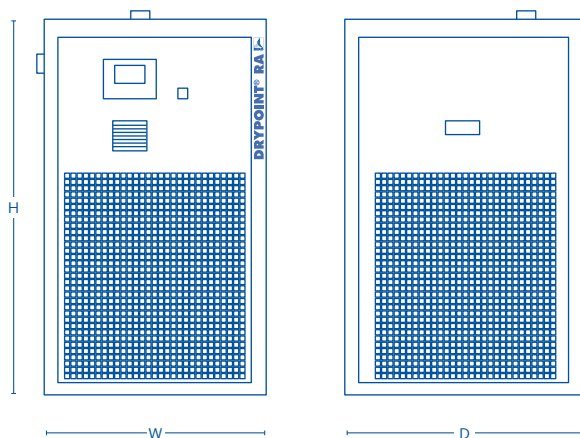

DRYPOINT® RA VSD	RA VSD 800	RA VSD 1000	RA VSD 1250	RA VSD 1500	RA VSD 1750	RA VSD 2000	RA VSD 2500
Connection Size (NPT)	3" Flange	3" Flange	3" Flange	4" Flange	4" Flange	4" Flange	4" Flange
Flow Rate (scfm)	800	1000	1250	1500	1750	2000	2500
Power Consumption at Full Load (kW)	2.80	4.10	5.00	5.80	6.40	8.00	10.10

Dimensions and Weight

H x W x D (inches)	58 x 31 x 39	58 x 31 x 39	58 x 31 x 39	69 x 45 x 47	69 x 45 x 47	69 x 45 x 47	69 x 45 x 47
Weight (lbs)	534	608	686	1,021	1,202	1,202	1,349

AIR COOLED REFRIGERANT DRYER WITH STANDARD VOLTAGE

Voltage	460 V / 3 Ph	460 V / 3 Ph	460 V / 3 Ph	460 V / 3 Ph	460 V / 3 Ph	460 V / 3 Ph	460 V / 3 Ph
Order ref.	4055158	4056611	4056612	4056613	4056614	4056615	4056616
Price (\$)	\$22,999	\$24,890	\$28,886	\$35,074	\$41,911	\$42,570	\$47,167

Price Group 51

WATER COOLED REFRIGERANT DRYER WITH STANDARD VOLTAGE

Voltage	460 V / 3 Ph	460 V / 3 Ph	460 V / 3 Ph	460 V / 3 Ph	460 V / 3 Ph	460 V / 3 Ph	460 V / 3 Ph
Order ref.	4056622	4056623	4056624	4056625	4056626	4056627	4056628
Price (\$)	\$23,493	\$25,424	\$29,505	\$35,826	\$42,811	\$43,485	\$48,181

Price Group 51

REQUIRED 1 µm PRE-FILTRATION

	M030	L100	L102
without Δpsi gauge Float Drain	4002903	-	-
Price (\$)	\$2,394	-	-
with Δpsi gauge BEKOMAT®	4010403	4020749	4020761
Price (\$)	\$2,715	\$6,315	\$7,865

Price Group 82

OPTIONAL .01 µm POST-FILTRATION

without Δpsi gauge Float Drain	4002963	4020750	4020762
Price (\$)	\$2,394	\$6,315	\$7,865

Price Group 82

- › Required pre-filtration: 1 µm | Recommended post-filtration: .01 µm
- › MODBUS ready
- › Outlet pressure dew point: Class 4-5 in accordance with ISO 8573-1:2010
- › Max. inlet air temperature: 160 °F
- › Min. / max. ambient temperature: 34 °F / 115 °F
- › Max. inlet pressure: 200 psig

Maintenance Interval: < 8,000 hours
 Maintenance and Spare Parts: Page 50
 Extended Warranty: Page 144

DRYPOINT® RA VSD	RA VSD 3000	RA VSD 3750	RA VSD 4000	RA VSD 5000	RA VSD 6000
Connection Size (NPT)	6" Flange	6" Flange	8" Flange	8" Flange	8" Flange
Flow Rate (scfm)	3000	3750	4000	5000	6000
Power Consumption at Full Load (kW)	11.20	13.80	15.40	17.10	22.30
Dimensions and Weight					
H x W x D (inches)	71 x 51 x 69	71 x 51 x 69	74 x 55 x 87	74 x 55 x 87	96 x 61 x 86
Weight (lbs)	1,850	2,090	2,350	2,670	3,660

AIR COOLED REFRIGERANT DRYER WITH STANDARD VOLTAGE

Voltage	460 V / 3 Ph	460 V / 3 Ph	460 V / 3 Ph	460 V / 3 Ph	460 V / 3 Ph
Order ref.	4056617	4056618	4056619	4056620	4056621
Price (\$)	\$64,667	\$71,653	\$83,043	\$98,872	\$120,172

Price Group 51

WATER COOLED REFRIGERANT DRYER WITH STANDARD VOLTAGE

Voltage	460 V / 3 Ph	460 V / 3 Ph	460 V / 3 Ph	460 V / 3 Ph	460 V / 3 Ph
Order ref.	4056629	4056630	4056631	4056632	4056633
Price (\$)	\$66,056	\$73,194	\$84,828	\$100,997	\$122,755

Price Group 51

REQUIRED 1 µm PRE-FILTRATION

	L150	L200
without Δpsi gauge Float Drain	-	-
Price (\$)	-	-
with Δpsi gauge BEKOMAT®	4020864	4057036
Price (\$)	\$9,408	\$14,155

Price Group 82

OPTIONAL .01 µm POST-FILTRATION

without Δpsi gauge Float Drain	4020865	4041302
Price (\$)	\$9,408	\$14,155

Price Group 82

Correction Factors

Operating Pressure psig	60	80	100	120	140	160	180	200
Correction Factor	.79	.91	1.00	1.07	1.13	1.18	1.23	1.27

Ambient Air Temperature °F	80	90	100	105	110	115
Correction Factor	1.11	1.09	1.00	.94	.87	.78

Inlet Air Temperature °F	90	100	110	120	130	140	150	160
Correction Factor	1.16	1.00	.82	.68	.61	.52	.45	.40

DRYPOINT® RA HT High Inlet Temperature Refrigeration Dryers

with integrated aftercooler and BEKOMAT® or timer drain

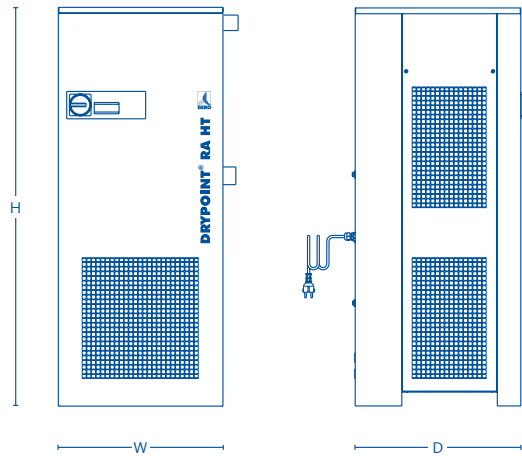

DRYPOINT® RA HT	RA HT 20	RA HT 30	RA HT 40	RA HT 50	RA HT 75
Flow Rate at 45 °F Outlet PDP (scfm)	20	30	40	50	75
Connection Size (NPT)	½"	½"	½"	½"	1"
Power Consumption - Load (kW)	.21	.28	.31	.48	.77
Operating Voltage	115 V / 1 Ph	115 V / 1 Ph	115 V / 1 Ph	115 V / 1 Ph	115 V / 1 Ph

Dimensions and Weight

H x W x D (inches)	25 x 17 x 16	25 x 17 x 16	25 x 17 x 16	25 x 17 x 16	45 x 16 x 18
Weight (lbs)	66	68	71	73	110

REFRIGERANT DRYER WITH BEKOMAT® DRAIN

ECO CHOICE

Order ref.	4050468	4050469	4050470	4050471	4050472
Price (\$)	\$3,110	\$3,480	\$3,952	\$4,249	\$4,794

REFRIGERANT DRYER WITH TIMER DRAIN

Order ref.	4050457	4050458	4050459	4050460	4050461
Price (\$)	\$2,912	\$3,037	\$3,522	\$4,034	\$4,237

Price Group 51

INCLUDED 1 µm PRE-FILTRATION

	S040	S050	S075	M010
without Δpsi gauge Built-in	4002920	4002921	4002923	4002924
Price (\$)	INCLUDED			

Price Group 82

OPTIONAL .01 µm POST-FILTRATION

	S045	S050	S100
without Δpsi gauge Float Drain	4020231	4002951	4020384
Price (\$)	\$250	\$278	\$409

Price Group 82

- › Integrated aftercooler
- › Pre-filter included
- › UL / CSA certified
- › Recommended post-filtration: .01 µm
- › Outlet pressure dew point: Class 6 in accordance with ISO 8573-1:2010
- › Max. inlet air temperature: 210 °F
- › Min. / max. ambient temperature: 34 °F / 120 °F
- › Max. inlet pressure: 200 psig

Maintenance Interval: < 8,000 hours
 Maintenance and Spare Parts: Page 50
 Extended Warranty: Page 144

DRYPOINT®RA HT	RA HT 100	RA HT 150	RA HT 200	RA HT 250	RA HT 300	RA HT 350
Flow Rate at 45 °F Outlet PDP (scfm)	100	150	200	250	300	350
Connection Size (NPT)	1¼"	1¼"	1½"	1½"	2"	2"
Power Consumption - Load (kW)	.88	1.14	1.28	1.57	2.13	2.68
Operating Voltage	115 V / 1 Ph	115 V / 1 Ph	230 V / 1 Ph	230 V / 1 Ph	230 V / 1 Ph	230 V / 1 Ph

Dimensions and Weight

H x W x D (inches)	49 x 20 x 20	49 x 20 x 20	55 x 22 x 23	55 x 22 x 23	59 x 28 x 31	59 x 28 x 31
Weight (lbs)	134	146	165	185	291	304

REFRIGERANT DRYER WITH BEKOMAT® DRAIN

ECO CHOICE

Order ref.	4050473	4050474	4050475	4050476	4050477	4050478
Price (\$)	\$5,900	\$6,775	\$8,749	\$9,606	\$12,681	\$13,899

REFRIGERANT DRYER WITH TIMER DRAIN

Order ref.	4050462	4050463	4050464	4050465	4050466	4050467
Price (\$)	\$5,547	\$5,958	\$8,040	\$8,883	\$11,804	\$13,128

Price Group 51

INCLUDED 1 µm PRE-FILTRATION

	M010	M015	M020
without Δpsi gauge Built-in	4002924	4002926	4002928
Price (\$)	INCLUDED		

Price Group 82

OPTIONAL .01 µm POST-FILTRATION

	S100	M010	M015	M020
without Δpsi gauge Float Drain	4020384	4002954	4002956	4002958
Price (\$)	\$409	\$427	\$702	\$972

Price Group 82

Correction Factors

Operating Pressure psig	60	80	100	120	140	160	180	200
Correction Factor	.79	.91	1.00	1.07	1.13	1.18	1.23	1.27

Ambient Air Temperature °F	80	90	100	105	110	115	120
Correction Factor	1.22	1.11	1.00	.94	.89	.83	.78

Inlet Air Temperature °F	140	160	170	180	195	210
Correction Factor	1.26	1.13	1.07	1.00	.90	.81

DRYPOINT® RS HP High Pressure Refrigeration Dryers

stainless steel heat exchanger with BEKOMAT® or timer drain

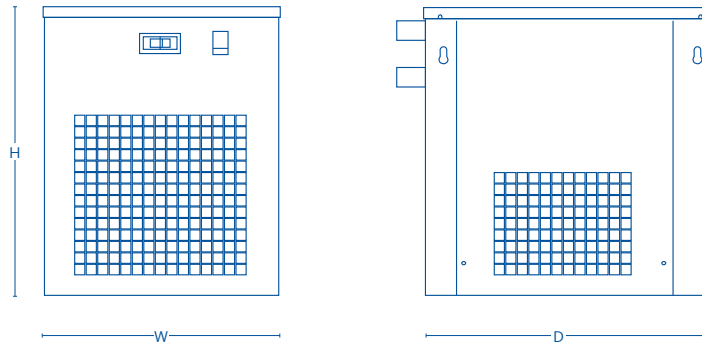

DRYPOINT® RS HP	RS HP 15	RS HP 30	RS HP 40	RS HP 50	RS HP 80	RS HP 100	RS HP 140	RS HP 180	RS HP 260
Connection Size (NPT)	3/8"	3/8"	3/8"	3/4"	3/4"	3/4"	3/4"	1"	1"
Flow Rate (scfm)	15	30	40	50	80	100	140	180	260
Operating Voltage	115 V / 1 Ph	115 V / 1 Ph	115 V / 1 Ph	115 V / 1 Ph	115 V / 1 Ph	115 V / 1 Ph	115 V / 1 Ph	115 V / 1 Ph	230 V / 1 Ph
Power Consumption Load (kW)	.16	.22	.33	.41	.49	.86	.89	.94	1.18

Dimensions and Weight

H x W x D (inches)	19 x 15 x 20	19 x 15 x 20	19 x 15 x 20	29 x 14 x 17	29 x 14 x 17	33 x 19 x 18	33 x 19 x 18	34 x 23 x 23	34 x 23 x 23
Weight (lbs)	62	64	71	84	86	110	117	196	223

REFRIGERANT DRYER WITH BEKOMAT® DRAIN

ECO CHOICE

Order ref.	4050485	4050487	4050489	4050501	4050502	4050503	4050504	4050505	4050511
Price (\$)	\$4,057	\$4,185	\$4,446	\$5,627	\$6,590	\$7,240	\$7,788	\$8,462	\$9,582

REFRIGERANT DRYER WITH TIMER DRAIN

Order ref.	4050479	4050480	4050481	4050491	4050492	4050493	4050494	4050495	4032047
Price (\$)	\$2,856	\$2,996	\$3,284	\$4,564	\$5,611	\$5,919	\$6,376	\$7,054	\$7,750

Price Group 50

REQUIRED 1 µm PRE-FILTRATION

	HP50S040	HP50S050	HP50S075	HP50M010
without Δpsi gauge BM Kit	4020169	4029877	4037961	4032540
Price (\$)	\$615	\$725	\$1,020	\$1,170

Price Group 82

OPTIONAL .01 µm POST-FILTRATION

without Δpsi gauge BM Kit	4012594	4029878	4047810	4032539
Price (\$)	\$615	\$725	\$1,020	\$1,170

Price Group 82

OPTIONAL EQUIPMENT

BEKOMAT® 12 CO PN63	2002931
Price (\$)	\$1,215

Price Group 10

- › Required pre-filtration: 1 µm | Recommended post-filtration: .01 µm
- › Outlet pressure dew point: Class 4-5 in accordance with ISO 8573-1:2010
- › Max. inlet air temperature: 150 °F
- › Min. / max. ambient temperature: 34 °F / 120 °F
- › Max. inlet pressure: RS HP 15-550: 725 psig | RS HP 700-3500: 650 psig

Maintenance Interval: < 8,000 hours
 Maintenance and Spare Parts: Page 50
 Extended Warranty: Page 144

DRYPOINT® RS HP	Max. 650 psig										
	RS HP 350	RS HP 450	RS HP 550	RS HP 700	RS HP 900	RS HP 1300	RS HP 1400	RS HP 1700	RS HP 2300	RS HP 2900	RS HP 3500
Connection Size (NPT)	1"	1½"	1½"	2"	2"	2"	3" Flange	3" Flange	3" Flange	3" Flange	3" Flange
Flow Rate (scfm)	350	450	550	700	900	1300	1400	1700	2300	2900	3500
Operating Voltage	230 V / 1 Ph	230 V / 1 Ph	460 V / 3 Ph	460 V / 3 Ph	460 V / 3 Ph	460 V / 3 Ph	460 V / 3 Ph	460 V / 3 Ph	460 V / 3 Ph	460 V / 3 Ph	460 V / 3 Ph
Power Consumption Load (kW)	1.39	1.93	2.75	3.00	3.30	4.25	5.20	5.95	6.90	8.00	-
Dimensions and Weight											
H x W x D (inches)	34 x 23 x 23	44 x 26 x 29	44 x 26 x 29	58 x 31 x 40	58 x 31 x 40	58 x 31 x 40	64 x 45 x 48	64 x 45 x 48	64 x 45 x 48	64 x 45 x 48	-
Weight (lbs)	254	344	414	556	584	862	979	1,016	1,071	1,217	-

REFRIGERANT DRYER WITH BEKOMAT® DRAIN											ECO CHOICE
Order ref.	4050512	4050513	4050514	4014309	4014310	4014311	4014312	4014313	4032048	4032049	4032050
Price (\$)	\$11,312	\$12,347	\$16,687	\$23,971	\$27,014	\$28,204	\$38,497	\$40,812	\$46,740	\$55,903	\$61,720

REFRIGERANT DRYER WITH TIMER DRAIN											
Order ref.	4015603	4015604	4015605	-	-	-	-	-	-	-	-
Price (\$)	\$10,243	\$11,758	\$16,656	-	-	-	-	-	-	-	-

Price Group 50

REQUIRED 1 µm PRE-FILTRATION	HP50M010	HP50M020	
without Δpsi gauge BM Kit	4032540	4015401	Consult Factory
Price (\$)	\$1,170	\$1,984	ON REQUEST

Price Group 82

OPTIONAL .01 µm POST-FILTRATION			
without Δpsi gauge BM Kit	4032539	4037533	Consult Factory
Price (\$)	\$1,170	\$1,984	ON REQUEST

Price Group 82

OPTIONAL EQUIPMENT		
BEKOMAT® 12 CO PN63		2002931
Price (\$)		\$1,215

Price Group 10

Correction Factors

Operating Pressure psig	200	300	400	500	550	580	650	725
Correction Factor	.53	.71	.84	.94	.98	1.00	1.05	1.10

Ambient Air Temperature °F	80	90	100	105	110	115	120
Correction Factor	1.11	1.09	1.00	.94	.87	.78	.69

Inlet Air Temperature °F	90	100	110	120	130	140	150
Correction Factor	1.16	1.00	.82	.68	.61	.52	.45

The correction factors on this page provide an estimation of the performance that can be achieved with the model sizes shown. For precise sizing for your application, please contact your BEKO Technologies sales representative.

DRYPOINT® RA LC Low Cooling Chillers
 compressed air and gas chiller technology with BEKOMAT®

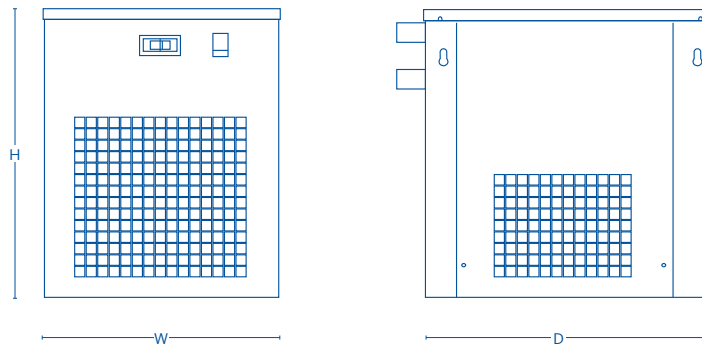

DRYPOINT® RA LC	RA LC 8	RA LC 22	RA LC 35	RA LC 50	RA LC 70	RA LC 90
Connection Size (NPT)	3/8"	3/8"	1/2"	3/4"	3/4"	1"
Flow Rate (scfm)	5	20	35	50	70	90
Operating Voltage	115 V / 1 Ph	115 V / 1 Ph	115 V / 1 Ph	115 V / 1 Ph	115 V / 1 Ph	115 V / 1 Ph
Power Consumption Load (kW)	.19	.39	.58	.86	.89	.94

Dimensions and Weight

H x W x D (inches)	19 x 15 x 20	19 x 15 x 20	29 x 14 x 17	33 x 20 x 18	33 x 20 x 18	35 x 23 x 23
Weight (lbs)	59	64	81	130	134	179

Order ref.	4050519	4050520	4011801	4011802	4011803	4011804
Price (\$)	\$2,739	\$3,047	\$4,374	\$5,398	\$6,334	\$7,130

Price Group 51

**REQUIRED 1 µm
 PRE-FILTRATION**

	S040	S050	S075	S100
without Δpsi gauge Float Drain	4002890	4002891	4002893	4020305
Price (\$)	\$234	\$278	\$374	\$409
with Δpsi gauge BEKOMAT®	4014030	4017447	4014031	4020404
Price (\$)	\$483	\$542	\$636	\$690

**OPTIONAL .01 µm
 POST-FILTRATION**

without Δpsi gauge Float Drain	4002950	4002951	4002953	4020384
Price (\$)	\$234	\$278	\$374	\$409

Price Group 82

- › Required pre-filtration: 1 µm | Recommended post-filtration: .01 µm
- › Outlet gas temperature: 41 °F
- › Max. inlet air temperature: 130 °F
- › Min. / max. ambient temperature: 34 °F / 120 °F
- › Max. inlet pressure: 220 psig

Maintenance Interval: < 8,000 hours
 Maintenance and Spare Parts: Page 50
 Extended Warranty: Page 144

DRYPOINT® RA LC	RA LC 140	RA LC 210	RA LC 280	RA LC 350	RA LC 420
Connection Size (NPT)	1"	1½"	2"	2"	2"
Flow Rate (scfm)	140	210	280	350	420
Operating Voltage	230 V / 1 Ph	230 V / 1 Ph	460 V / 3 Ph	460 V / 3 Ph	460 V / 3 Ph
Power Consumption Load (kW)	1.86	2.12	3.30	3.80	4.25

Dimensions and Weight

H x W x D (inches)	35 x 23 x 23	44 x 26 x 29	58 x 31 x 40	58 x 31 x 42	58 x 31 x 42
Weight (lbs)	262	280	481	518	540

Order ref.	4011805	4011806	4011807	4011808	4013099
Price (\$)	\$8,591	\$11,785	\$18,780	\$20,592	\$20,928

Price Group 51

**REQUIRED 1 µm
PRE-FILTRATION**

	M010	M015	M020
without Δpsi gauge Float Drain	4002894	4002896	4002898
Price (\$)	\$427	\$702	\$972
with Δpsi gauge BEKOMAT®	4014546	4016192	4006657
Price (\$)	\$734	\$974	\$1,268

**OPTIONAL .01 µm
POST-FILTRATION**

without Δpsi gauge Float Drain	4002954	4002956	4002958
Price (\$)	\$409	\$702	\$972

Price Group 82

Correction Factors

Operating Pressure psig	60	80	100	120	140	160	180	200	220
Correction Factor	.79	.91	1.00	1.07	1.13	1.18	1.23	1.27	1.30

Ambient Air Temperature °F	80	90	95	100	105	110	115	120
Correction Factor	1.00	.94	.90	.86	.81	.76	.70	.63

Inlet Air Temperature °F	80	90	95	100	110	120	130
Correction Factor	1.39	1.11	1.00	.88	.68	.53	.46

DRYPOINT® RA Maintenance

■ replacement filter elements

Maintenance Interval: < 8,000 hours

Filter Housing	Pre-Filter FX (1 µm)	Post-Filter SX (.01 µm)	Price (\$)
S040 / S045	4038104	4038111	\$88
S050	4038139	4038148	\$113
S055	4038105	4038112	\$134
S075 / S100	4038106	4038113	\$142
M010	4038140	4038149	\$169
M015	4038108	4038115	\$235
M019 / M020	4038142	4038151	\$323
M025	4038109	4038116	\$453
M030	4038146	4038155	\$760
L100	4038110 x 2	4038117 x 2	\$846
L102	4038110 x 3	4038117 x 3	\$1,269
L150	4038110 x 4	4038117 x 4	\$1,692
L200	4038110 x 8	4038117 x 8	\$3,384

Price Group 86

■ service unit for BEKOMAT® drains

Maintenance Interval: < 8,000 hours

	RAc 10 - 300	RAc 375 - 480	RAx 20 - 350	RAx 400 - 5000
BEKOMAT® Service Unit	4023608	4023573	4023608	4023573
Price (\$)	\$141	\$186	\$141	\$186

Price Group 12

■ timer drains - for UL certified dryers

Maintenance Interval: < 8,000 hours

	RAc 10 - 100 115 VAC	RAc 125 - 150 115 VAC	RAc 175-480 230 VAC
Solenoid Valve	4015497	4038211	4038211
Price (\$)	\$46	\$104	\$104
Coil	4029884	4029884	4029883
Price (\$)	\$74	\$74	\$74

Price Group 53

■ drain maintenance for RA HT dryers

Maintenance Interval: < 8,000 hours

	RA HT 20 - 100 115 VAC	RA HT 150 115 VAC	RA HT 100 230 VAC	RA HT 150 230 VAC	RA HT 200 - 350 230 VAC
Solenoid Valve	4015497	4015497	4015497	4015497	4038211
Price (\$)	\$46	\$46	\$46	\$46	\$104
Coil	4029884	4015508	4044438	4044438	4044438
Price (\$)	\$74	\$69	\$71	\$71	\$71

Price Group 53

BEKOMAT® Service Unit	4023608	4023573	4023608	4023573	4023573
Price (\$)	\$141	\$186	\$141	\$186	\$186

Price Group 12

DRYPOINT® RA Spare Parts

■ for RAc series dryers UL - 115 VAC from model year 2015 and above

DRYPOINT® RAc	RAc 10	RAc 15	RAc 20	RAc 35	RAc 50
Refrigerant Compressor	4035837			4015172	
Price (\$)	\$413			\$570	
Condenser	4015185	4015182			4015184
Price (\$)	\$74	\$106			\$206
Hot Gas By-Pass Valve	4015230				
Price (\$)	\$221				
Fan Motor	4015214				4015215
Price (\$)	\$106				\$120
Dehydration Filter	4035838		4012705		
Price (\$)	\$9		\$11		
Dryer Controller (DMC 15)	4015196				
Price (\$)	\$166				
Lighted Switch	4012682				
Price (\$)	\$20				
BEKOMAT®	4025280				
Price (\$)	\$208				
Temperature Probe	4010768				
Price (\$)	\$59				

Price Group 53

DRYPOINT® RAc	RAc 75	RAc 100	RAc125	RAc150
Refrigerant Compressor	4015173	4015160	4015154	
Price (\$)	\$744	\$786	\$1,083	
Condenser	4015184	4015186	4035839	4035840
Price (\$)	\$206	\$246	\$246	\$360
Hot Gas By-Pass Valve	4015230		4022079	
Price (\$)	\$221		\$346	
Fan Motor	4015215	4015216	4028542	
Price (\$)	\$120	\$148	\$298	
Dehydration Filter	4012705		4012706	
Price (\$)	\$11		\$53	
Dryer Controller (DMC 15)	4015196			
Price (\$)	\$166			
Lighted Switch	4012682			
Price (\$)	\$20			
BEKOMAT®	4025280			
Price (\$)	\$208			
Temperature Probe	4010768			
Price (\$)	\$59			
PV Pressure Switch	-	-	4015576	
Price (\$)	-	-	\$207	

Price Group 53

DRYPOINT® RA Spare Parts

■ for RAc series dryers UL - 115 VAC from model year 2020 and above

DRYPOINT® RAc	RAc 10	RAc 15	RAc 20	RAc 35	RAc 50
Refrigerant Compressor	4035837			4015172	
Price (\$)	\$413			\$570	
Condenser	4044382	4044383			4044384
Price (\$)	\$68	\$100			\$192
Hot Gas By-Pass Valve	4015230				
Price (\$)	\$221				
Fan Motor	4050892				4050893
Price (\$)	\$100				\$114
Dehydration Filter	4012705				
Price (\$)	\$11				
Dryer Controller (DMC 35)	4050888				
Price (\$)	\$151				
Lighted Switch	4012682				
Price (\$)	\$20				
BEKOMAT®	4025280				
Price (\$)	\$208				
Temperature Probe	4046053				
Price (\$)	\$21				

Price Group 53

DRYPOINT® RAc	RAc 75	RAc 100	RAc125	RAc150
Refrigerant Compressor	4015173	4015160	4015154	
Price (\$)	\$744	\$786	\$1,083	
Condenser	4044384	4035839	4035842	4035840
Price (\$)	\$192	\$246	\$387	\$360
Hot Gas By-Pass Valve	4015230		4022079	
Price (\$)	\$221		\$346	
Fan Motor	4050894	4050895	4050896	
Price (\$)	\$132	\$132	\$240	
Dehydration Filter	4012705		4012706	
Price (\$)	\$11		\$53	
Dryer Controller (DMC 35)	4050888		4050889	
Price (\$)	\$151		\$151	
Lighted Switch	4012682			
Price (\$)	\$20			
BEKOMAT®	4025280			
Price (\$)	\$208			
Temperature Probe	4046053			
Price (\$)	\$21			
Pressure Transducer	-	-	4046319	
Price (\$)	-	-	\$166	

Price Group 53

DRYPOINT® RA Spare Parts

■ for RAc series dryers UL - 230v from model year 2015 and above

DRYPOINT® RAc	RAc 175	RAc 220	RAc 300	RAc 375	RAc 480
Refrigerant Compressor	4015155		4015165	4015157	
Price (\$)	\$1,083		\$1,119	\$1,601	
Condenser	4035840	4035841	4013705	4015190	4022030
Price (\$)	\$360	\$499	\$667	\$1,004	\$1,132
Hot Gas By-Pass Valve	4022079				
Price (\$)	\$346				
Fan Motor	4022055	4029885	-		
Price (\$)	\$176	\$252	-		
Complete Fan	-		4027483		
Price (\$)	-		\$1,294		
Dehydration Filter	4012706	4012707			
Price (\$)	\$53	\$67			
Dryer Controller (DMC 15)	4014071				
Price (\$)	\$183				
Lighted Switch	4012682	-			
Price (\$)	\$20	-			
Main Switch	-		4025708		
Price (\$)	-		\$95		
BEKOMAT®	4025280			4025040	
Price (\$)	\$208			\$254	
Temperature Probe	4010768				
Price (\$)	\$59				
PV Pressure Switch	4015576		4012693		
Price (\$)	\$207		\$198		
Low Pressure Switch	-			4012690	
Price (\$)	-			\$204	
High Pressure Switch	-		4012692		
Price (\$)	-		\$356		
Thermo Safety Switch	-		4012691		
Price (\$)	-		\$96		

Price Group 53

DRYPOINT® RA Spare Parts

■ for RAc series dryers UL - 230v from model year 2020 and above

DRYPOINT® RAc	RAc 175	RAc 220	RAc 300	RAc 375	RAc 480
Refrigerant Compressor	4015155		4015165	4015157	
Price (\$)	\$1,083		\$1,119	\$1,601	
Condenser	4035840	4035841	4044440	4044441	4022030
Price (\$)	\$360	\$499	\$625	\$944	\$1,132
Hot Gas By-Pass Valve	4022079				
Price (\$)	\$346				
Fan Motor	4053733	4050897	-		
Price (\$)	\$188	\$237	-		
Complete Fan	-		4027483		
Price (\$)	-		\$1,294		
Dehydration Filter	4012706	4012707			
Price (\$)	\$53	\$67			
Dryer Controller (DMC 35)	4050889				
Price (\$)	\$151				
Lighted Switch	4012682	-			
Price (\$)	\$20	-			
Main Switch	-		4025708		
Price (\$)	-		\$95		
BEKOMAT®	4025280			4025040	
Price (\$)	\$208			\$254	
Temperature Probe	4046053				
Price (\$)	\$21				
Pressure Transducer	4046319				
Price (\$)	\$166				
Contactora (KC1)	-	4022080			
Price (\$)	-	\$98 ea.			
Solid State Relay (KF)	-		4050903		
Price (\$)	-		\$100		
Low Pressure Switch	-				4022105
Price (\$)	-				\$119
High Pressure Switch	-		4022102		
Price (\$)	-		\$132		
Thermo Safety Switch	-	4046057			
Price (\$)	-	\$86			

Price Group 53

DRYPOINT® RA Spare Parts

■ for RAx series dryers UL - 115v from model year 2015 and above

DRYPOINT® RAx	RAx 20	RAx 30	RAx 50	RAx 75	RAx 100
Refrigerant Compressor	4035837	4015172	4021996	4015173	4015160
Price (\$)	\$413	\$570	\$699	\$744	\$786
Condenser	4015182		4015186		4022029
Price (\$)	\$106		\$246		\$448
Hot Gas By-Pass Valve	4012694				
Price (\$)	\$344				
Fan Motor	4015215				4028542
Price (\$)	\$120				\$298
Dehydration Filter	4012705				
Price (\$)	\$11				
Dryer Controller (DMC 18)	4021469				
Price (\$)	\$264				
Lighted Switch	4012682				
Price (\$)	\$20				
BEKOMAT®	4027640				
Price (\$)	\$208				
Temperature Probe	4010768				
Price (\$)	\$59				
PV Pressure Switch	4015576				
Price (\$)	\$207				

Price Group 53

DRYPOINT® RAx	RAx 125	RAx 150	RAx 200
Refrigerant Compressor	4015154		
Price (\$)	\$1,083		
Condenser	4035842	4035840	4035841
Price (\$)	\$387	\$360	\$499
Hot Gas By-Pass Valve	4022079		
Price (\$)	\$346		
Fan Motor	4028542		
Price (\$)	\$298		
Dehydration Filter	4012706		4012707
Price (\$)	\$53		\$67
Dryer Controller (DMC 18)	4021469		
Price (\$)	\$264		
Main Switch	4025708		
Price (\$)	\$95		
BEKOMAT®	4027640		
Price (\$)	\$208		
Temperature Probe	4010768		
Price (\$)	\$59		
Thermo Safety Switch	4012691		
Price (\$)	\$96		
PV Pressure Switch	4015576		
Price (\$)	\$207		

Price Group 53

DRYPOINT® RA Spare Parts

■ for RAx series dryers UL - 230v from model year 2015 and above

DRYPOINT® RAx	RAx 125	RAx 150	RAx 200	RAx 250	RAx 300	RAx 350	RAx 400	RAx 500
Refrigerant Compressor	4015155			4015165	4015167	4015157	4022015	
Price (\$)	\$1,083			\$1,119	\$1,155	\$1,601	\$2,142	
Condenser	4035842	4035840	4035841	4035843	4013705	4015190	4035844	4022031
Price (\$)	\$387	\$360	\$499	\$537	\$667	\$1,004	\$1,133	\$1,547
Hot Gas By-Pass Valve	4022079							
Price (\$)	\$346							
Fan Motor	4022055		4029885		-			
Price (\$)	\$176		\$252		-			
Complete Fan	-		-		4027483		4029894	
Price (\$)	-		-		\$1,294		\$1,294	
Dehydration Filter	4012706			4012707				
Price (\$)	\$53			\$67				
Dryer Controller Display (DMC 18)	4021469							
Price (\$)	\$264							
Main Switch	4025708							
Price (\$)	\$95							
BEKOMAT®	4027640						4027642	
Price (\$)	\$208						\$254	
Temperature Probe	4010768							
Price (\$)	\$59							
Thermo Safety Switch	4012691							
Price (\$)	\$96							
PV Pressure Switch	4015576				4012693			
Price (\$)	\$207				\$198			
Low Pressure Switch	-				4012690			
Price (\$)	-				\$204			
High Pressure Switch	-				4012692			
Price (\$)	-				\$356			

Price Group 53

DRYPOINT® RA Spare Parts

■ for RAx series dryers CE - 460v from model year 2015 and above

DRYPOINT® RAx	RAx 200	RAx 250	RAx 300	RAx 350	RAx 400	RAx 500
Refrigerant Compressor	4021997			4021998	4015171	4015159
Price (\$)	\$1,967			\$1,705	\$2,379	\$3,543
Condenser	4035843	4013705		4015190	4035844	4022031
Price (\$)	\$537	\$667		\$1,004	\$1,133	\$1,547
Hot Gas By-Pass Valve	4012694			4022079		
Price (\$)	\$344			\$346		
Complete Fan	4027449			4025504		
Price (\$)	\$759			\$1,299		
Dehydration Filter	4012707					
Price (\$)	\$67					
Dryer Controller Display (DMC 18)	4021469					
Price (\$)	\$264					
Lighted Switch	4012682					
Price (\$)	\$20					
Main Switch	4022100					
Price (\$)	\$264					
BEKOMAT®	4027640			4027642		
Price (\$)	\$208			\$254		
Temperature Probe	4010768					
Price (\$)	\$59					
Thermo Safety Switch	4012691					
Price (\$)	\$96					
PV Pressure Switch	4015576					
Price (\$)	\$207					
Low Pressure Switch	4022106			4022105		
Price (\$)	\$125			\$119		
High Pressure Switch	4022101			4022102		
Price (\$)	\$120			\$132		
Fuse Kit	4022072					
Price (\$)	\$176					
Contactora (KC1, KV1)	4022080					
Price (\$)	\$98					
Transformer	4022164					
Price (\$)	\$198					

Price Group 53

DRYPOINT® RA Spare Parts

■ for RAx series dryers UL - 460v from model year 2019 and above

DRYPOINT® RAx	RAx 200	RAx 250	RAx 300	RAx 350	RAx 400	RAx 500
Refrigerant Compressor	4021997		4021998		4015171	4015159
Price (\$)	\$1,967		\$1,705		\$2,379	\$3,543
Condenser	4035843	4044440		4044441	4035844	4022031
Price (\$)	\$537	\$625		\$944	\$1,133	\$1,547
Hot Gas By-Pass Valve	4012694			4022079		
Price (\$)	\$344			\$346		
Complete Fan	4048639			4048545		
Price (\$)	\$666			\$1,277		
Dehydration Filter	4012707					
Price (\$)	\$67					
Dryer Controller Display (DMC 18)	4021469					
Price (\$)	\$264					
Lighted Switch	4012682					
Price (\$)	\$20					
Main Switch	4022100					
Price (\$)	\$264					
BEKOMAT®	4027640			4027642		
Price (\$)	\$208			\$254		
Temperature Probe	4010769					
Price (\$)	\$61					
Thermo Safety Switch	4012691					
Price (\$)	\$96					
PV Pressure Switch	4015576					
Price (\$)	\$207					
Low Pressure Switch	4022106			4022105		
Price (\$)	\$125			\$119		
High Pressure Switch	4022101			4022102		
Price (\$)	\$120			\$132		
Fuse Kit	4022072					
Price (\$)	\$176					
Contactora (KC1, KV1)	4048636					
Price (\$)	\$312					
Transformer	4022164					
Price (\$)	\$198					

Price Group 53

DRYPOINT® RA Spare Parts

■ for RAx series dryers UL - 460v from model year 2015 and above

DRYPOINT® RAx	RAx 600	RAx 800	RAx 1000	RAx 1250
Refrigerant Compressor	4029897	4029898	4029900	4027382
Price (\$)	\$3,098	\$3,165	\$3,295	\$3,706
Condenser	4015193		4015194	4015181
Price (\$)	\$1,217		\$1,453	\$2,154
Hot Gas By-Pass Valve		4022079		
Price (\$)		\$346		
Complete Fan	4026622		4025397	
Price (\$)	\$1,876		\$1,876	
Dehydration Filter		4012708		
Price (\$)		\$104		
Dryer Controller Display (DMC 24)		4022048		
Price (\$)		\$195		
Main Switch		4012684		
Price (\$)		\$332		
BEKOMAT®		4027648		
Price (\$)		\$254		
Temperature Probe		4022116		
Price (\$)		\$63		
Pressure Transducer		4022156		
Price (\$)		\$267		
Low Pressure Switch		4022105		
Price (\$)		\$119		
High Pressure Switch		4022102		
Price (\$)		\$132		
Circuit Breaker (QC1)		4035845		
Price (\$)		\$532		
Circuit Breaker (QV1)		4035850		
Price (\$)		\$528		
Aux Contact (QC1-QV1)		4035854		
Price (\$)		\$75		
Fuse Kit		4035856		
Price (\$)		\$102		
Contactors (KC1, KV0, KV1, KV2)		4035858		
Price (\$)		\$516		
Mechanical Interlock (KV)		4035861		
Price (\$)		\$44		
Relay (KHP)		4047280		
Price (\$)		\$90		
Transformer		4022165		
Price (\$)		\$287		
Reverse phase protector		4028258		
Price (\$)		\$304		

Price Group 53

DRYPOINT® RA Spare Parts

■ for RAx series dryers UL - 460v from model year 2015 and above

DRYPOINT® RAx	RAx 1500	RAx 1750	RAx 2000	RAx 2500	RAx 3000	RAx 4000	RAx 5000
Refrigerant Compressor	4025357		4029901	4022022	4022023	4022024	4022026
Price (\$)	\$3,247		\$4,259	\$7,638	\$8,410	\$8,939	\$17,924
Condenser	4015194		4015181				
Price (\$)	\$1,453		\$2,154				
Hot Gas By-Pass Valve	4013530			4012697	4012698	4022077	
Price (\$)	\$1,718			\$1,801	\$4,348	\$3,176	
Pilot Valve				-			4015987
Price (\$)				-			\$2,713
Complete Fan				4025397			
Price (\$)				\$1,876			
Dehydration Filter	4022063			4029902 and 4029903			
Price (\$)	\$180			\$479 + \$75			
Controller Display (DMC 24)				4022048			
Price (\$)				\$195			
Main Switch	4012684			4012685			
Price (\$)	\$332			\$332			
BEKOMAT®				4027648			
Price (\$)				\$254			
Temperature Probe				4022116			
Price (\$)				\$63			
Pressure Transducer				4022156			
Price (\$)				\$267			
Low Pressure Switch				4022105			
Price (\$)				\$119			
High Pressure Switch				4022102			
Price (\$)				\$132			
Circuit Breaker (QC1)	4035846		4035847		4035848	4035849	
Price (\$)	\$604		\$635		\$718	\$1,475	
Circuit Breaker (QV1)	4035851		4035852			4035853	
Price (\$)	\$556		\$532			\$560	
Aux Contact (QC1-QV1)			4035854				
Price (\$)			\$75				
Aux Contact (QC1)			-		4035855		
Price (\$)			-		\$92		
Aux Contact (QV1)			-		4035854		
Price (\$)			-		\$75		
Fuse Kit	4035856		4035857				
Price (\$)	\$102		\$79				
Contactors (KC1, KV0-2)			4035858				-
Price (\$)			\$516				-
Contactors (KC1)			-				4035859
Price (\$)			-				\$1,304
Contactors (KV0-2)			-				4035858
Price (\$)			-				\$516
Mechanical Interlock (KV)			4035861				
Price (\$)			\$44				
Relay (KHP, KDR)	4047280		-				
Price (\$)	\$90		-				
Relay (KHP)	-		4047280				
Price (\$)	-		\$90				
Relay (KDR)	-		4047281				
Price (\$)	-		\$88				
Transformer	4022165		4022166				
Price (\$)	\$287		\$644				
Reverse phase protector			4028258				
Price (\$)			\$304				

DRYPOINT® RA Spare Parts

■ for RAx series dryers UL - 460v from model year 2018 and above

DRYPOINT® RAx	RAx 6000	RAx 7500	RAx 8000	RAx 10000
Refrigerant Compressor	4022026		4048792	4022026 x2
Price (\$)	\$17,924		\$15,523	\$17,924 ea.
Condenser	4044386	4044387	Consult Factory	Consult Factory
Price (\$)	\$6,144	\$8,917	ON REQUEST	ON REQUEST
Hot Gas By-Pass Valve	4022077			
Price (\$)	\$3,176			
Pilot Valve	4015987			
Price (\$)	\$2,713			
Complete Fan	4044388		4048793	
Price (\$)	\$6,764		\$6,130	
Dehydration Filter Housing	4029902		4048794	
Price (\$)	\$479		\$757	
Dehydration Filter Element	4029903		4029903 x2	
Price (\$)	\$75		\$75 ea.	
Controller Display (DMC 24)	4022048			
Price (\$)	\$195			
Main Switch	4012685			
Price (\$)	\$332			
BEKOMAT®	4027648			
Price (\$)	\$254			
Temperature Probe	4022116			
Price (\$)	\$63			
Pressure Transducer	4022156			
Price (\$)	\$267			
Low Pressure Switch	4022105			
Price (\$)	\$119			
High Pressure Switch	4022102			
Price (\$)	\$132			
Circuit Breaker (QC1)	4044389		4044390	-
Price (\$)	\$587		\$2,045	-
Circuit Breaker (QV1)	4035852		-	-
Price (\$)	\$532		-	-
Circuit Breaker (QV1-QV2)	-		4035851	-
Price (\$)	-		\$556	-
Aux Contact (QC1-QV1)	4035854 x2			-
Price (\$)	\$75 ea.			-
Aux Contact (QC1)	4035855			-
Price (\$)	\$92			-
Contactors (KC1)	4035859			-
Price (\$)	\$1,304			-
Contactors (KV0-KV2)	4035858			-
Price (\$)	\$516			-
Aux Contact (KC1)	4035854 and 4044393			-
Price (\$)	\$75 + \$53			-
Relay (KHP)	4047280			-
Price (\$)	\$90			-
Relay (KDR)	4047281 x2			-
Price (\$)	\$88 ea.			-
Transformer	4022166			-
Price (\$)	\$644			-
Reverse phase protector	4028258			-
Price (\$)	\$304			-

Price Group 53

DRYPOINT® RA Spare Parts

■ for RA CT series dryers UL - 115v from model year 2016 and above

DRYPOINT® RA CT	RA CT 20	RA CT 30	RA CT 50	RA CT 75	RA CT 100	RA CT 125	RA CT 150	RA CT 200
Refrigerant Compressor	4035837	4015172	4021996	4015173	4015160	4015154		
Price (\$)	\$413	\$570	\$699	\$744	\$786	\$1,083		
Condenser	4015182		4035839	4015186	4035842		4035840	4035841
Price (\$)	\$106		\$246	\$246	\$387		\$360	\$499
Hot Gas By-Pass Valve	4015230				4022079			
Price (\$)	\$221				\$346			
Fan Motor	4015215				4028542			
Price (\$)	\$120				\$298			
Dehydration Filter	4012705				4012706		4012707	
Price (\$)	\$11				\$53		\$67	
Check valve	-				4029887			
Price (\$)	-				\$88			
Liquid solenoid valve (EVL)	4015492				4015493			4015493
Price (\$)	\$111				\$180			\$180
Coil for EVL	4029890							
Price (\$)	\$66							
Hot gas solenoid valve (EVH)	4015492				4015493			4015493
Price (\$)	\$111				\$180			\$180
Coil for EVH	4029890							
Price (\$)	\$66							
Controller Display (DMC 51)	4027528							
Price (\$)	\$79							
Main Module (DMC 51)	4035740							
Price (\$)	\$201							
Display Cable (DMC 51)	4027529							
Price (\$)	\$26							
Main Switch	4012682				4025708			
Price (\$)	\$20				\$95			
BEKOMAT®	4025280							
Price (\$)	\$208							
Temperature Probe	4029886							
Price (\$)	\$66							
PV Pressure Switch	4015576							
Price (\$)	\$207							

Price Group 53

DRYPOINT® RA Spare Parts

■ for RA CT series dryers UL - 230v from model year 2016 and above

DRYPOINT® RA CT	RA CT 125	RA CT 150	RA CT 200	RA CT 250	RA CT 300	RA CT 350	RA CT 400	RA CT 500
Refrigerant Compressor	4015155			4015165	4015167	4015157	4022015	
Price (\$)	\$1,083			\$1,119	\$1,155	\$1,601	\$2,142	
Condenser	4035842	4035840	4035841	4035843	4044440	4015190	4035844	4022031
Price (\$)	\$387	\$360	\$499	\$537	\$625	\$1,004	\$1,133	\$1,547
Hot Gas By-Pass Valve	4022079							
Price (\$)	\$346							
Complete Fan	-				4027483		4029894	
Price (\$)	-				\$1,294		\$1,294	
Fan Motor	4022055		4029885		-		-	
Price (\$)	\$176		\$252		-		-	
Dehydration Filter	4037241			4012707				
Price (\$)	\$53			\$67				
Check valve	4029887				4029888		4029889	
Price (\$)	\$88				\$96		\$112	
Liquid solenoid valve (EVL)	4015492			4015493				
Price (\$)	\$111			\$180				
Coil for EVL	4029891							
Price (\$)	\$61							
Hot gas solenoid valve (EVH)	4015492			4015493				
Price (\$)	\$111			\$180				
Coil for EVH	4029891							
Price (\$)	\$61							
Controller Display (DMC 51)	4027528							
Price (\$)	\$79							
Main Module (DMC 51)	4035740							
Price (\$)	\$201							
Display Cable (DMC 51)	4027529							
Price (\$)	\$26							
Main Switch	4025708							
Price (\$)	\$95							
BEKOMAT®	4025280						4025040	
Price (\$)	\$208						\$254	
Temperature Probe	4029886			4029886 x2				
Price (\$)	\$66			\$66 ea.				
PV Pressure Switch	4015576							
Price (\$)	\$207							
Low Pressure Switch	-				4022105			
Price (\$)	-				\$119			
High Pressure Switch	-				4022102			
Price (\$)	-				\$132			

Price Group 53

DRYPOINT® RA Spare Parts

■ For RA CT series dryers CE – 460v from model year 2016 and above.

DRYPOINT® RA CT	RA CT 200	RA CT 250	RA CT 300	RA CT 350	RA CT 400	RA CT 500
Refrigerant Compressor	4021997			4021998	4015171	4015159
Price (\$)	\$1,967			\$1,705	\$2,379	\$3,543
Condenser	4035843	4044440		4015190	4035844	4022031
Price (\$)	\$537	\$625		\$1,004	\$1,133	\$1,547
Hot Gas By-Pass Valve	4012694			4022079		
Price (\$)	\$344			\$346		
Complete Fan	4027449			4025504		
Price (\$)	\$759			\$1,299		
Dehydration Filter	4012707					
Price (\$)	\$67					
Check valve	4029887	4029888		4029889		
Price (\$)	\$88	\$96		\$112		
Liquid solenoid valve (EVL)	4015493					
Price (\$)	\$180					
Coil for EVL	4029891					
Price (\$)	\$61					
Hot gas solenoid valve (EVH)	4015493					
Price (\$)	\$180					
Coil for EVH	4029891					
Price (\$)	\$61					
Controller Display (DMC 51)	4027528					
Price (\$)	\$79					
Main Module (DMC 51)	4035741			4035740		
Price (\$)	\$219			\$201		
Display Cable (DMC 51)	4044410					
Price (\$)	\$21					
Main Switch	4022100					
Price (\$)	\$264					
Lighted Switch	4012682					
Price (\$)	\$20					
BEKOMAT®	4025280			4025040		
Price (\$)	\$208			\$254		
Temperature Probe	4029886					
Price (\$)	\$66					
PV Pressure Switch	4015576					
Price (\$)	\$207					
Low Pressure Switch	4022106			4022105		
Price (\$)	\$125			\$119		
High Pressure Switch	4022101			4022102		
Price (\$)	\$120			\$132		
Fuse Kit	4022072					
Price (\$)	\$176					
Contactora (KC1)	4022080					
Price (\$)	\$98 ea.					
Transformer	4022164					
Price (\$)	\$198					

Price Group 53

DRYPOINT® RA Spare Parts

■ For RA CT series dryers UL – 460v from model year 2020 and above.

DRYPOINT® RA CT	RA CT 200	RA CT 250	RA CT 300	RA CT 350	RA CT 400	RA CT 500
Refrigerant Compressor	4021997			4021998	4015171	4015159
Price (\$)	\$1,967			\$1,705	\$2,379	\$3,543
Condenser	4035843	4044440		4015190	4035844	4022031
Price (\$)	\$537	\$625		\$1,004	\$1,133	\$1,547
Hot Gas By-Pass Valve	4012694			4022079		
Price (\$)	\$344			\$346		
Complete Fan	4048639			4048545		
Price (\$)	\$666			\$1,277		
Dehydration Filter	4051221					
Price (\$)	\$67					
Liquid solenoid valve (EVL)	4015493					
Price (\$)	\$180					
Coil for EVL	4044409		4029891			
Price (\$)	\$52		\$61			
Hot gas solenoid valve (EVH)	4015493					
Price (\$)	\$180					
Coil for EVH	4029891	-	-	-	-	-
Price (\$)	\$61	-	-	-	-	-
Controller Display (DMC 51)	4027528					
Price (\$)	\$79					
Main Module (DMC 51)	4035741				4035740	
Price (\$)	\$219				\$201	
Display Cable (DMC 51)	4044410					
Price (\$)	\$21					
Main Switch	4053902					
Price (\$)	\$596					
Lighted Switch	4012682					
Price (\$)	\$20					
BEKOMAT®	4025280				4025040	
Price (\$)	\$208				\$254	
Temperature Probe	4029886					
Price (\$)	\$66					
PV Pressure Switch	4015576					
Price (\$)	\$207					
Low Pressure Switch	4022106				4022105	
Price (\$)	\$125				\$119	
High Pressure Switch	4022101				4022102	
Price (\$)	\$120				\$132	
Contactor (KC1)	4048636					
Price (\$)	\$312					
Transformer	4022164					
Price (\$)	\$198					

Price Group 53

DRYPOINT® RA Spare Parts

■ for RA VSD series dryers CE - 460v from model year 2016 and above

DRYPOINT® RA VSD ECO	RA VSD 800	RA VSD 1000	RA VSD 1250	RA VSD 1500	RA VSD 1750	RA VSD 2000
VSD Compressor	4037447					4037448
Price (\$)	\$2,812					\$2,907
Compressor Inverter	4037460					4037461
Price (\$)	\$297					\$593
Condenser	4015193	4015194	4015181	4015194 x2		4015181 x2
Price (\$)	\$1,217	\$1,453	\$2,154	\$1,453 ea.		\$2,154 ea.
Complete Fan	4026622	4025397		4025397 x2		
Price (\$)	\$1,876	\$1,876		\$1,876 ea.		
Electrical Panel Fan	4037466					
Price (\$)	\$1,876					
Condenser Fan Inverter	4037462	4037463		4037464		
Price (\$)	\$1,283	\$1,283		\$1,933		
Dehydration Filter	4029903					
Price (\$)	\$75					
Dryer Controller Display (DMC 50)	Consult Factory - Dryer serial number required					
Price (\$)	ON REQUEST					
Main Switch	4012684					
Price (\$)	\$332					
BEKOMAT®	4027648			4027648 x2		
Price (\$)	\$254			\$254 ea.		
Electronic Expansion Valve (EEVN)	4044421			4044421 x2		
Price (\$)	\$130			\$130 ea.		
EEV Controller	4044411	4044412		4044412 x2		
Price (\$)	\$297	\$651		\$651 ea.		
Coil for EEVN	4044422			4044422 x2		
Price (\$)	\$157			\$157 ea.		
Electrical Panel Filter	4044427			4044428		
Price (\$)	\$297			\$593		
Pressure Balancing Solenoid Valve	4015492			4015493		
Price (\$)	\$111			\$180		
Coil for PBSV	4015511					
Price (\$)	\$593					
Temperature Probe	4029886 x4					
Price (\$)	\$66 ea.					
Pressure Transducer	4037453	4044423				
Price (\$)	\$267	\$267				
EEV Temperature Probe	4044429			4044429 x2		
Price (\$)	\$85			\$85 ea.		
EEV Pressure Transducer	4044430			4044430 x2		
Price (\$)	\$293			\$293 ea.		
Low Pressure Switch	4022106	4022105				
Price (\$)	\$125	\$119				
High Pressure Switch	4022101	4022102				
Price (\$)	\$120	\$132				
Transformer	4044417					
Price (\$)	\$516					
Relay (KEN)	4015978					
Price (\$)	\$90					
Relay (KDR)	-			4015978		
Price (\$)	-			\$90		
Relay (KDAAn)	4044403			4044403 x2		
Price (\$)	\$90			\$90 ea.		

Price Group 53

DRYPOINT® RA Spare Parts

■ for RA VSD series dryers CE - 460v from model year 2016 and above

DRYPOINT® RA VSD ECO	RA VSD 2500	RA VSD 3000	RA VSD 3750	RA VSD 4000	RA VSD 5000	RA VSD 6000
VSD Compressor	4037448					
Price (\$)	\$2,907					
Fixed Speed Compressor	-	4029900	4027382	4027382 x2	4025357 x2	
Price (\$)	-	\$3,295	\$3,706	\$3,706 ea.	\$3,247 ea.	
Compressor Inverter	4037461					
Price (\$)	\$593					
Condenser	4015181 x2	4015181 x3		4015181 x4		4044386
Price (\$)	\$2,154 ea.	\$2,154 ea.		\$2,154 ea.		\$6,144
Complete Fan	4025397 x2	4025397 x3		4025397 x4		4041416 x2
Price (\$)	\$1,876 ea.	\$1,876 ea.		\$1,876 ea.		\$3,750 ea.
Electrical Panel Fan	4037466					
Price (\$)	\$1,876					
Condenser Fan Inverter	4037464	4044398		4044399		-
Price (\$)	\$1,933	\$2,979		\$3,392		-
Dehydration Filter	4029903					
Price (\$)	\$75					
Dryer Controller Display (DMC 50)	Consult Factory - Dryer serial number required					
Price (\$)	ON REQUEST					
Main Switch	4012684			4012685		
Price (\$)	\$332			\$332		
BEKOMAT®	4027648 x2	4027648 x3		4027648 x4		4027648 x6
Price (\$)	\$254 ea.	\$254 ea.		\$254 ea.		\$254 ea.
Electronic Expansion Valve (EEVN)	4044421 x2	4044421 x3		4044421 x4		4044421 x6
Price (\$)	\$130 ea.	\$130 ea.		\$130 ea.		\$130 ea.
EEV Controller	4044412 x2	4044412 x3		4044412 x4		4044412 x6
Price (\$)	\$651 ea.	\$651 ea.		\$651 ea.		\$651 ea.
Coil for EEVN	4044422 x 2	4044422 x3		4044422 x4		4044422 x6
Price (\$)	\$157 ea.	\$157 ea.		\$157 ea.		\$157 ea.
Electrical Panel Filter	4044428					
Price (\$)	\$593					
Pressure Balancing Solenoid Valve	4015493			4044397		
Price (\$)	\$180			\$297		
Coil for PBSV	4015511					
Price (\$)	\$593					
Temperature Probe	4029886 x4					
Price (\$)	\$66 ea.					
Pressure Transducer	4044423					
Price (\$)	\$267					
EEV Temperature Probe	4044429 x2	4044429 x3		4044429 x4		4044429 x6
Price (\$)	\$85 ea.	\$85 ea.		\$85 ea.		\$85 ea.
EEV Pressure Transducer	4044430 x2	4044430 x3		4044430 x4		4044430 x6
Price (\$)	\$293 ea.	\$293 ea.		\$293 ea.		\$293 ea.
Low Pressure Switch	4022105					
Price (\$)	\$119					
High Pressure Switch	4022102					
Price (\$)	\$132					
Transformer	4044417		4044418			4044419
Price (\$)	\$516		\$604			\$872
Relay (KEN)	4015978					
Price (\$)	\$90					
Relay (KDR)		-			4015978	
Price (\$)		-			\$90	
Relay (KdAn)		4044403			4044403 x2	
Price (\$)		\$90			\$90 ea.	
Reverse phase protector	4028258					
Price (\$)	\$304					



Desiccant Drying

DRYPOINT® X

efficient low dew point desiccant drying

- › ACC compact heatless desiccant air dryers
- › XCe economy heatless desiccant air dryers
- › XCp premium heatless desiccant air dryers
- › XFe economy heated blower desiccant air dryers
- › XFi ecoIntelligent heated blower desiccant air dryers
- › ACH heated purge desiccant air dryers
- › AC HP heatless high pressure desiccant air dryers

DRYPOINT® ACC Compact Heatless Desiccant Dryers

with pre-filtration and post-filtration* included

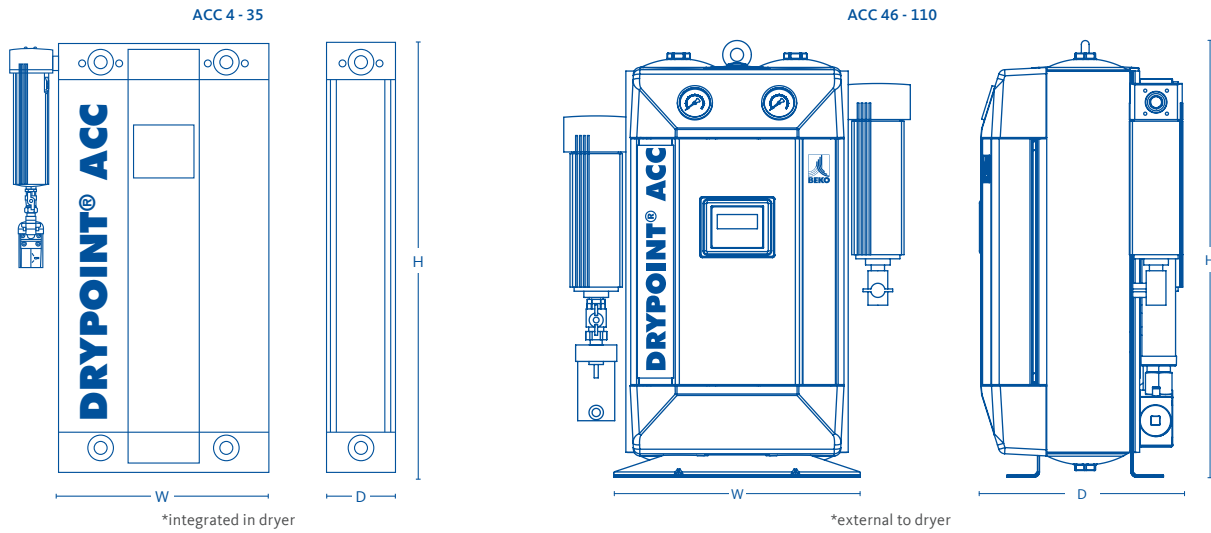

DRYPOINT® ACC	ACC 4	ACC 6	ACC 8	ACC 10	ACC 15	ACC 25	ACC 35
Flow Rate at -40 °F (scfm)	4	6	8	10	15	25	35
Flow Rate at -100 °F (scfm)	3	4	6	7	11	18	25
Connection Size (NPT)	3/8"	3/8"	3/8"	3/8"	3/8"	3/8"	3/8"
Dimensions and Weight							
H x W x D (inches)	18 x 11 x 4	20 x 11 x 4	22 x 11 x 4	25 x 11 x 4	32 x 11 x 4	42 x 11 x 4	58 x 11 x 4
Weight (lbs)	29	31	33	36	43	53	68

HEATLESS DESICCANT DRYER WITH FLOAT DRAIN

Order ref. (-40 °F or -100 °F)	4022746	4022748	4012623	4012625	4012626	4012627	4012628
Price (\$)	\$2,125	\$2,254	\$2,448	\$2,640	\$2,962	\$4,054	\$5,111

HEATLESS DESICCANT DRYER WITH BEKOMAT®

Order ref. (-40 °F or -100 °F)	4022749	4022750	4012639	4012640	4012641	4012642	4012643
Price (\$)	\$2,319	\$2,448	\$2,640	\$2,833	\$3,154	\$4,248	\$5,304

ECO CHOICE

Price Group 62

OPTIONAL EQUIPMENT

Wall Mounting Bracket	4008702
Price (\$)	\$269
Floor Mounting Bracket	4009870
Price (\$)	\$269

Price Group 69

- › Standard pressure dew point: -40 °F or -100 °F
- › Standard intelligent power supply: 12 - 24 VDC/ 100 - 240 VAC; 50/60 Hz
- › Min. / max. air inlet temperature: 35 °F / 120 °F
- › Min. / max. ambient temperature: 41 °F / 120 °F
- › Min. / max. operating pressure: 58 / 232 psig (ACC 4-35), 189 psig (ACC 46-110)

Maintenance Interval: < 8,000 hours
 Maintenance and Spare Parts: Page 90
 Extended Warranty: Page 144

DRYPOINT® ACC	ACC 46	ACC 56	ACC 75	ACC 90	ACC 110
Flow Rate at -40 °F (scfm)	45	55	75	90	110
Flow Rate at -100 °F (scfm)	34	42	57	69	84
Connection Size (NPT)	1"	1"	1"	1"	1"
Dimensions and Weight					
H x W x D (inches)	26 x 15 x 12	29 x 15 x 12	37 x 15 x 12	41 x 15 x 12	50 x 15 x 12
Weight (lbs)	106	117	142	160	192

HEATLESS DESICCANT DRYER WITH FLOAT DRAIN

Order ref. (-40 °F)	4050733	4050734	4050735	4050736	4050737
Price (\$)	\$5,544	\$5,980	\$6,255	\$6,829	\$9,393
Order ref. (-100 °F)	4054019	4054020	4054021	4054022	4054023
Price (\$)	\$5,813	\$6,227	\$6,365	\$7,063	\$9,610

HEATLESS DESICCANT DRYER WITH BEKOMAT®

					ECO CHOICE
Order ref. (-40 °F)	4050738	4050739	4050740	4050741	4050742
Price (\$)	\$5,712	\$6,148	\$6,422	\$6,997	\$9,561
Order ref. (-100 °F)	4054024	4054025	4054026	4054027	4054028
Price (\$)	\$5,999	\$6,413	\$6,552	\$7,249	\$9,796

Price Group 69

Correction Factors

Operating Pressure (psig)	60	70	80	90	100	110	120	130	140	150
Correction Factor	.64	.73	.81	.90	1.00	1.08	1.16	1.25	1.33	1.41
Inlet Air Temperature °F	80	85	90	95	100	105	110	115	120	
Correction Factor	1.17	1.11	1.06	1.00	.86	.74	.68	.61	.49	

The correction factors on this page provide an estimation of the performance that can be achieved with the model sizes shown. For precise sizing for your application, please contact your BEKO Technologies sales representative.

DRYPOINT® XCe Economy Heatless Desiccant Dryers

with basic controller and slanted seat valves

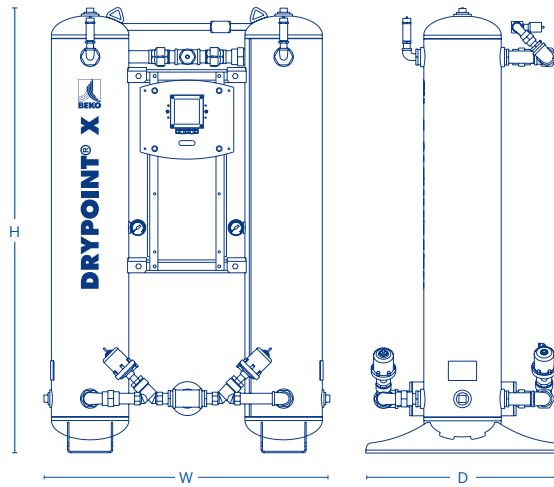

DRYPOINT® XCe	XCe 80	XCe100	XCe 120	XCe 160	XCe 200	XCe 250
Connection Size (NPT)	¾"	1"	1"	1¼"	1¼"	1½"
Flow Rate (scfm)	80	100	120	160	200	250
Dimensions and Weight						
H x W x D (inches)	54 x 37 x 22	64 x 38 x 23	64 x 38 x 23	68 x 40 x 26	68 x 40 x 26	69 x 45 x 30
Empty Weight (lbs)	232	295	296	320	320	413
Total Fill (lbs)	132	167	167	262	262	384

HEATLESS DESICCANT DRYER WITHOUT FILTERS (FILTRATION REQUIRED)

Order ref.	4026930	4026931	4026932	4026933	4026934	4026935
Price (\$)	\$7,541	\$7,911	\$8,187	\$8,821	\$9,795	\$10,395

HEATLESS DESICCANT DRYER WITH MOUNTED FILTERS

Order ref.	4027010	4027011	4027012	4027013	4027014	4027015
Price (\$)	\$8,743	\$9,180	\$9,737	\$10,601	\$11,668	\$12,936

HEATLESS DESICCANT DRYER WITH MOUNTED FILTERS AND 3-VALVE BYPASS

Order ref.	4032017	4032018	4032019	4032020	4032021	4032022
Price (\$)	\$9,070	\$9,573	\$10,345	\$11,287	\$12,421	\$13,318

Price Group 60

REQUIRED FILTERS, NOT MOUNTED

	S075	S100	M010	M012	M015
Pre-Filter .01 µm	4003404	4020388	4003524	4007053	4003405
Price (\$)	\$439	\$492	\$522	\$590	\$769
Post-Filter 1 µm	4021029	4021030	4021031	4024402	4021032
Price (\$)	\$374	\$409	\$427	\$494	\$702

Price Group 82

OPTIONAL EQUIPMENT

Drain Upgrade to BEKOMAT®	4047670
Price (\$)	\$391
Stainless Steel Tubing	4048882
Price (\$)	\$1,870

Price Group 12

- › Standard outlet pressure dew point: -40 °F
- › Electrical power supply: 120 VAC | 50 - 60Hz
- › Required pre-filtration grade SX: .01 µm | Required post-filtration grade FX: 1 µm
- › cULus listed controller with NEMA 4 indoor rating
- › ASME / CRN coded vessels
- › Min. / max. inlet air temperature: 40 °F / 120 °F
- › Min. / max. operating pressure: 60 / 150 psig

Maintenance Interval: < 8,000 hours
 Maintenance and Spare Parts: Page 86
 Extended Warranty: Page 144

DRYPOINT® XCe	XCe 300	XCe 400	XCe 500	XCe 650	XCe 800
Connection Size (NPT)	1½"	2"	2"	2½"	2½"
Flow Rate (scfm)	300	400	500	650	800
Dimensions and Weight					
H x W x D (inches)	69 x 45 x 30	71 x 49 x 35	73 x 53 x 36	74 x 57 x 40	71 x 61 x 43
Empty Weight (lbs)	412	594	717	871	925
Total Fill (lbs)	384	539	715	917	1,114

HEATLESS DESICCANT DRYER WITHOUT FILTERS (FILTRATION REQUIRED)

Order ref.	4026936	4026937	4026938	4026939	4026940
Price (\$)	\$11,586	\$13,379	\$15,042	\$17,897	\$21,699

HEATLESS DESICCANT DRYER WITH MOUNTED FILTERS

Order ref.	4027016	4027017	4027018	4027019	4027020
Price (\$)	\$14,340	\$16,341	\$18,863	\$23,267	\$27,330

HEATLESS DESICCANT DRYER WITH MOUNTED FILTERS AND 3-VALVE BYPASS

Order ref.	4032023	4032024	4032025	4032026	4032027
Price (\$)	\$14,720	\$16,865	\$19,720	\$24,841	\$28,982

Price Group 60

**REQUIRED FILTERS,
NOT MOUNTED**

	M018	M020	M025
Pre-Filter .01 µm	4014542	4003406	4021904
Price (\$)	\$836	\$983	\$2,180
Post-Filter 1 µm	4021033	4007876	4021036
Price (\$)	\$778	\$972	\$2,109

Price Group 82

OPTIONAL EQUIPMENT

Drain Upgrade to BEKOMAT®	4047670
Price (\$)	\$391
Stainless Steel Tubing	4048882
Price (\$)	\$1,870

Price Group 12

Correction Factors

Operating Pressure (psig)	60	70	80	90	100	110	120	130	140	150	Inlet Air Temperature °F	90	95	100	105	110	115	120
Correction Factor	0.65	0.74	0.82	0.91	1.00	1.09	1.17	1.22	1.25	1.30	Correction Factor	1.07	1.04	1.00	0.92	0.84	0.77	0.70

The correction factors on this page provide an estimation of the performance that can be achieved with the model sizes shown. For precise sizing for your application, please contact your BEKO Technologies sales representative.

DRYPOINT® XCp Premium Heatless Desiccant Dryers

with standard humidity demand control and BEKOTOUCH interface

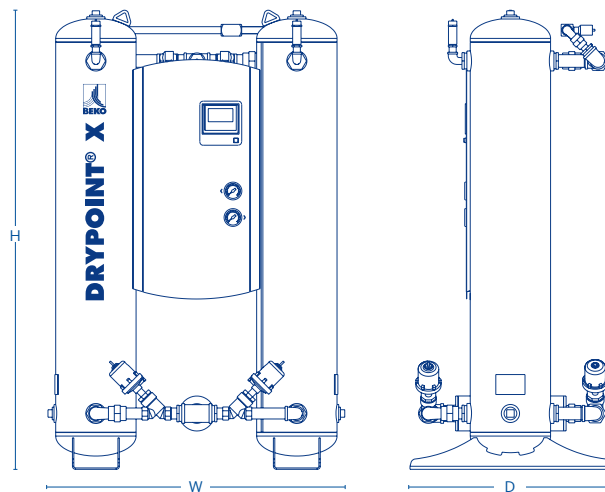

DRYPOINT®XCp	XCp 80	XCp 100	XCp 120	XCp 160	XCp 200	XCp 250	XCp 300	XCp 400	XCp 500
Connection Size (NPT)	¾"	1"	1"	1¼"	1¼"	1½"	1½"	2"	2"
Flow Rate (scfm)	80	100	120	160	200	250	300	400	500
Dimensions and Weight									
H x W x D (inches)	54 x 37 x 22	64 x 38 x 23	64 x 38 x 23	68 x 40 x 26	68 x 40 x 26	69 x 45 x 30	69 x 45 x 30	71 x 49 x 35	73 x 53 x 36
Empty Weight (lbs)	251	314	315	339	339	433	432	613	736
Total Fill (lbs)	132	167	167	262	262	384	384	539	715

HEATLESS DESICCANT DRYER WITHOUT FILTERS (FILTRATION REQUIRED)

Order ref.	4026941	4026942	4026943	4026944	4026945	4026946	4026947	4026948	4026949
Price (\$)	\$11,203	\$11,689	\$12,035	\$12,791	\$14,019	\$15,183	\$16,435	\$18,251	\$20,668

HEATLESS DESICCANT DRYER WITH MOUNTED FILTERS

Order ref.	4027494	4027495	4027496	4027497	4027498	4027499	4027500	4027501	4027502
Price (\$)	\$12,518	\$13,091	\$13,583	\$14,569	\$15,893	\$17,723	\$19,187	\$21,215	\$24,490

HEATLESS DESICCANT DRYER WITH MOUNTED FILTERS AND 3-VALVE BYPASS

Order ref.	4029343	4029524	4032028	4032029	4029557	4032030	4032031	4032032	4030934
Price (\$)	\$12,758	\$13,434	\$14,190	\$15,254	\$16,645	\$18,485	\$19,950	\$22,262	\$25,346

Price Group 60

REQUIRED FILTERS, NOT MOUNTED

	S075	S100	M010	M012	M015	M018	M020
Pre-Filter .01 µm	4003404	4020388	4003524	4007053	4003405	4014542	4003406
Price (\$)	\$439	\$492	\$522	\$590	\$769	\$836	\$983
Post-Filter 1 µm	4021029	4021030	4021031	4024402	4021032	4021033	4007876
Price (\$)	\$374	\$409	\$427	\$494	\$702	\$778	\$972

Price Group 82

Correction Factors

Operating Pressure (psig)	60	70	80	90	100	110	120	130	140	150	Inlet Air Temperature °F	90	95	100	105	110	115	120
Correction Factor	0.65	0.74	0.82	0.91	1.00	1.09	1.17	1.22	1.25	1.30	Correction Factor	1.07	1.04	1.00	0.92	0.84	0.77	0.70

The correction factors above provide an estimation of the performance that can be achieved with the model sizes shown. For precise sizing for your application, please contact your BEKO Technologies sales representative.

Flow Rate at -40 °F PDP (scfm)	80	100	120	160	200	250	300	400	500
Correction Factor for -100 °F PDP	0.8								

Sizing for -100 °F outlet PDP applications must be done by a product specialist. Please consult your BEKO Technologies representative for details and sizing assistance.

- › Standard outlet pressure dew point: -40 °F
- › Optional outlet pressure dew point*: -100 °F
- › Electrical power supply: 120 VAC | 50 - 60Hz
- › Required pre-filtration grade SX: .01 µm | Required post-filtration grade FX: 1 µm
- › cULus listed controller with NEMA 4 indoor rating
- › ASME / CRN coded vessels
- › Min. / max. inlet air temperature: 40 °F / 120 °F
- › Min. / max. operating pressure: 60 / 150 psig

Maintenance Interval: < 8,000 hours
 Maintenance and Spare Parts: Page 86
 Extended Warranty: Page 144

OPTIONAL EQUIPMENT

DRYPOINT® XcP	XcP 80	XcP 100	XcP 120	XcP 160	XcP 200	XcP 250	XcP 300	XcP 400	XcP 500
Drain Upgrade to BEKOMAT®	4047670								
Price (\$)	\$391								
Price Group 12									
Stainless Steel Tubing	4048557								
Price (\$)	\$1,870								
Dryer Outdoor Protection Package (above +32 °F)	4048559								
Price (\$)	\$2,064								
Dryer Outdoor Protection Package (down to -20 °F)	4048561						4048562		
Price (\$)	\$6,537						\$7,212		
Dryer and Filter Outdoor Protection Package (down to -20 °F)	4048564						4048565		
Price (\$)	\$8,600						\$9,668		
-100 °F Outlet Pressure Dew Point*	4048567				4048568			4048569	
Price (\$)	\$800				\$854			\$931	
Dew Point Monitor with Display for -40 °F	4028343								
Price (\$)	\$2,461								
Dew Point Monitor with Display for -100 °F*	4040512								
Price (\$)	\$4,670								
Failure to Switch Pressure Alarm	4029530								
Price (\$)	\$675								
Δp Filter Alarm with Gauge	4029531								
Price (\$)	\$514								
MODBUS Communication Package	4047031								
Price (\$)	\$479								

Price Group 63

*See required correction factors on page 74. Optional dew point monitor with display for -100 °F does not provide for dew point demand control.

Not all option combinations are compatible with each other, please consult your BEKO Technologies representative for details and assistance.

DRYPOINT® XCp Premium Heatless Desiccant Dryers

with standard humidity demand control and BEKOTOUCH interface

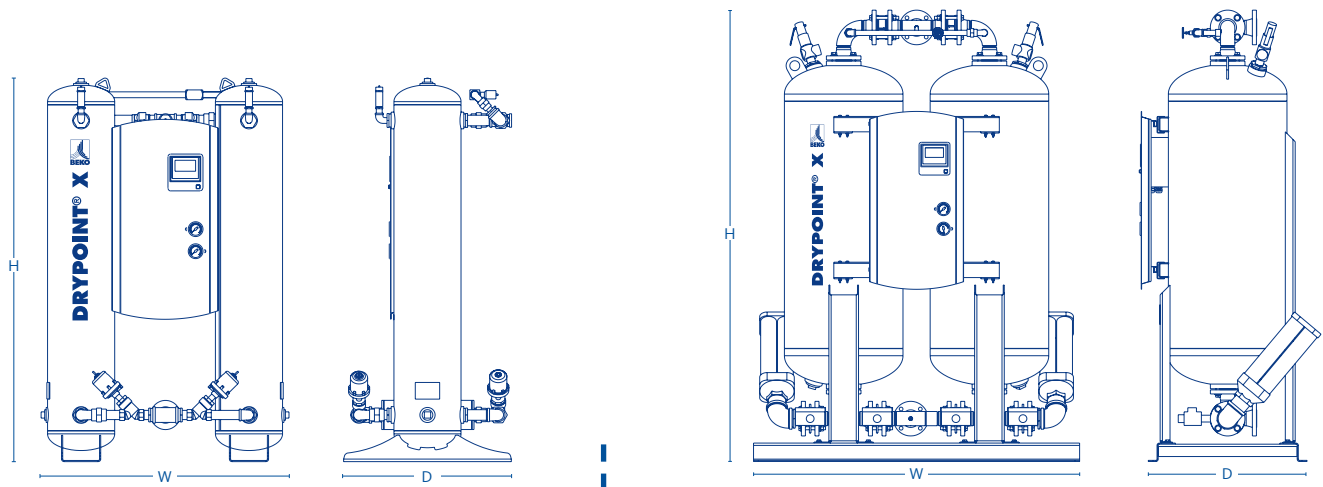

DRYPOINT®XCp	XCp 650	XCp 800	XCp 1000	XCp 1200	XCp 1500	XCp 1900	XCp 2300	XCp 2800
Connection Size (NPT)	2½"	2½"	2½" Flange	2½" Flange	3" Flange	3" Flange	4" Flange	4" Flange
Flow Rate (scfm)	650	800	1000	1200	1500	1900	2300	2800
Dimensions and Weight								
H x W x D (inches)	74 x 57 x 40	71 x 61 x 43	90 x 66 x 32	91 x 66 x 37	91 x 72 x 44	96 x 72 x 44	103 x 78 x 48	103 x 78 x 48
Empty Weight (lbs)	892	944	1,490	1,792	2,814	2,814	4,168	4,168
Total Fill (lbs)	917	1,114	1,120	1,355	1,840	2,110	3,125	3,125

HEATLESS DESICCANT DRYER WITHOUT FILTERS (FILTRATION REQUIRED)

Order ref.	4026950	4026951	4029915	4029916	4029917	4029918	4029919	4029920
Price (\$)	\$23,196	\$27,958	\$31,556	\$35,141	\$43,910	\$48,039	\$58,648	\$64,073

HEATLESS DESICCANT DRYER WITH MOUNTED FILTERS

Order ref.	4027503	4027504	4029921	4029922	4029923	4029924	4029925	4029926
Price (\$)	\$28,895	\$33,772	\$38,340	\$42,308	\$54,600	\$60,332	\$77,908	\$84,384

HEATLESS DESICCANT DRYER WITH MOUNTED FILTERS AND 3-VALVE BYPASS

Order ref.	4032033	4032034	4029927	4029928	4029929	4029930	4029931	4029932
Price (\$)	\$30,810	\$35,572	\$40,389	\$44,357	\$57,005	\$62,739	\$81,798	\$88,953

Price Group 60

REQUIRED FILTERS, NOT MOUNTED

	M025	M027	M030	M032	L102
Pre-Filter .01 µm	4020558	4047760	4007153	4021297	4020762
Price (\$)	\$2,387	\$2,516	\$2,715	\$3,143	\$7,865
Post-Filter 1 µm	4021036	4030249	4021037	4043755	4021056
Price (\$)	\$2,109	\$2,195	\$2,394	\$2,823	\$7,410

Price Group 82

Correction Factors

Operating Pressure (psig)	60	70	80	90	100	110	120	130	140	150	Inlet Air Temperature °F	90	95	100	105	110	115	120
Correction Factor	0.65	0.74	0.82	0.91	1.00	1.09	1.17	1.22	1.25	1.30	Correction Factor	1.07	1.04	1.00	0.92	0.84	0.77	0.70

The correction factors above provide an estimation of the performance that can be achieved with the model sizes shown. For precise sizing for your application, please contact your BEKO Technologies sales representative.

Flow Rate at -40 °F PDP (scfm)	650	800	1000	1200	1500	1900	2300	2800
Correction Factor for -100 °F PDP	0.8							

- › Standard outlet pressure dew point: -40 °F
- › Optional outlet pressure dew point*: -100 °F
- › Electrical power supply: 120 VAC | 50 - 60Hz
- › Required pre-filtration grade SX: .01 µm | Required post-filtration grade FX: 1 µm
- › cULus listed controller with NEMA 4 indoor rating
- › ASME / CRN coded vessels
- › Min. / max. inlet air temperature: 40 °F / 120 °F
- › Min. / max. operating pressure: 60 / 150 psig

Maintenance Interval: < 8,000 hours
 Maintenance and Spare Parts: Page 86
 Extended Warranty: Page 144

OPTIONAL EQUIPMENT

DRYPOINT® XcP	XcP 650	XcP 800	XcP 1000	XcP 1200	XcP 1500	XcP 1900	XcP 2300	XcP 2800
Stainless Steel Tubing	4048557					4048558		
Price (\$)	\$1,870					\$2,140		
Dryer Outdoor Protection Package (above +32 °F)	4048559					4048560		
Price (\$)	\$2,064					\$2,717		
Dryer Outdoor Protection Package (down to -20 °F)	4048563		4048938		4048939		4048940	
Price (\$)	\$7,845		ON REQUEST		ON REQUEST		ON REQUEST	
Dryer and Filter Outdoor Protection Package (down to -20 °F)	4048566		4048941		4048942		4048943	
Price (\$)	\$10,582		ON REQUEST		ON REQUEST		ON REQUEST	
-100 °F Outlet Pressure Dew Point*	4048569		4048947		4048948		4048949	
Price (\$)	\$931		\$952		\$1,047		\$1,151	
Dew Point Monitor with Display for -40 °F				4028343				
Price (\$)				\$2,461				
Dew Point Monitor with Display for -100 °F*				4040512				
Price (\$)				\$4,670				
Failure to Switch Pressure Alarm				4029530				
Price (\$)				\$675				
Δp Filter Alarm with Gauge				4029531				
Price (\$)				\$514				
MODBUS Communication Package				4047031				
Price (\$)				\$479				

Price Group 63

*See required correction factors on page 76. Optional dew point monitor with display for -100 °F does not provide for dew point demand control.

DRYPOINT® XFe Economy Heated Blower Desiccant Dryers

with externally operated blower, high performance valves and **BEKOTOUCH 2** interface

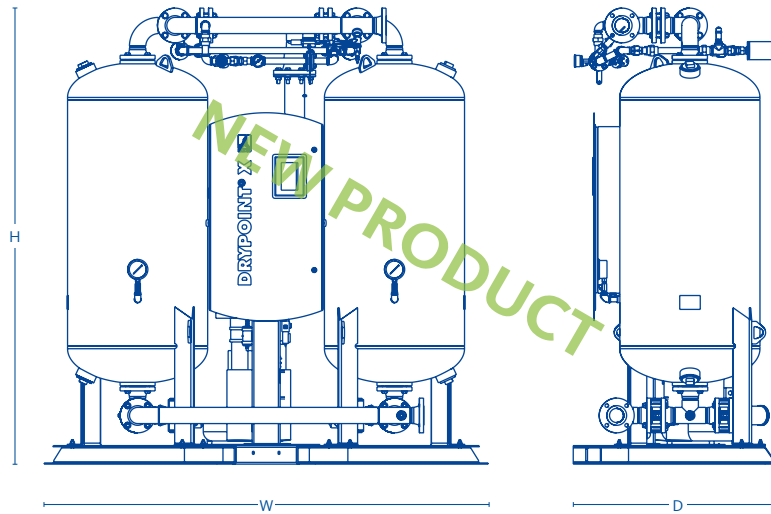

DRYPOINT® XFe	XFe 800	XFe 1000	XFe 1200	XFe 1500	XFe 1800
Connection Size (NPT)	2½" Flange	2½" Flange	3" Flange	3" Flange	4" Flange
Flow Rate (scfm)	800	1000	1200	1500	1800
Dimensions and Weight					
H x W x D (inches)	110 x 95 x 39	111 x 95 x 39	115 x 106 x 47	99 x 106 x 47	118 x 126 x 54
Empty Weight (lbs)	1,841	2,222	2,417	2,486	3,354
Total Fill (lbs)	1,260	1,570	1,890	2,370	2,840

HEATED BLOWER DESICCANT DRYER WITHOUT FILTERS (FILTRATION REQUIRED)

Order ref.	4052633	4052634	4052635	4052636	4052637
Price (\$)	\$66,957	\$75,161	\$79,002	\$94,314	\$101,453

Price Group 60

REQUIRED FILTERS, NOT MOUNTED

	M025	M030	L100
Pre-Filter .01 µm	4020558	4007153	4020750
Price (\$)	\$2,387	\$2,715	\$6,315
Post-Filter 1 µm	4021036	4021037	4032234
Price (\$)	\$2,109	\$2,394	\$5,877

Price Group 82

STANDALONE SKID-MOUNTED FILTRATION PACKAGE (PIPING KIT NOT INCLUDED)

Order ref.	4049687	4049689	4049691
Price (\$)	\$7,575	\$8,469	\$16,426

STANDALONE SKID-MOUNTED FILTRATION PACKAGE WITH 3-VALVE BYPASS (PIPING KIT NOT INCLUDED)

Order ref.	Consult Factory	Consult Factory	Consult Factory
Price (\$)	\$13,040	\$14,520	\$23,371

Price Group 60

OPTIONAL EQUIPMENT

Piping Kit for Filtration Packages	4048570	4048571	4048572	4048573	4048574
Price (\$)	ON REQUEST				
Dew Point Demand Control	4034925				
Price (\$)	\$2,657				
Δp Filter Alarm with Gauge	4029531				
Price (\$)	\$514				
Valve Position Indicators	4034919				
Price (\$)	\$1,859				
Tower Insulation (indoor only)	4034853	4034859	4034865	4034871	4034877
Price (\$)	\$3,982	\$4,125	\$4,312	\$4,505	\$4,642

Price Group 63

- › Standard outlet pressure dew point: -40 °F
- › Electrical power supply: 460 VAC / 3 Ph / 60 Hz
- › Required pre-filtration grade SX: .01 µm | Required post-filtration grade FX: 1 µm
- › cUL certified controls with NEMA 4 indoor rating
- › Min. / max. inlet air temperature: 40 °F / 120 °F
- › Min. / max. ambient temperature: 40 °F / 120 °F
- › Min. / max. operating pressure: 60 / 150 psig

Maintenance Interval: < 8,000 hours
 Maintenance and Spare Parts: Page 86
 Extended Warranty: Page 144

DRYPOINT® XFe	XFe 2300	XFe 2800	XFe 3300	XFe 4000	XFe 5000	XFe 6000
Connection Size (NPT)	4" Flange	4" Flange	6" Flange	6" Flange	6" Flange	6" Flange
Flow Rate (scfm)	2300	2800	3300	4000	5000	6000
Dimensions and Weight						
H x W x D (inches)	112 x 126 x 54	127 x 126 x 54	121 x 148 x 71	138 x 149 x 71	137 x 192 x 66	136 x 192 x 66
Empty Weight (lbs)	3,951	3,967	4,766	5,507	7,206	8,422
Total Fill (lbs)	3,640	4,390	5,180	6,260	7,820	9,380

HEATED BLOWER DESICCANT DRYER WITHOUT FILTERS (FILTRATION REQUIRED)

Order ref.	4052638	4052639	4052640	4052641	4052642	4052643
Price (\$)	\$116,696	\$130,184	\$166,825	\$189,063	\$215,985	\$250,470

Price Group 60

REQUIRED FILTERS, NOT MOUNTED

	L102	L150	L156
Pre-Filter .01 µm	4020762	4045133	4047776
Price (\$)	\$7,865	\$9,408	\$11,613
Post-Filter 1 µm	4021056	4048944	4021058
Price (\$)	\$7,410	\$8,950	\$11,155

Price Group 82

STANDALONE SKID-MOUNTED FILTRATION PACKAGE (PIPING KIT NOT INCLUDED)

Order ref.	4049693	4049695	4049697
Price (\$)	\$21,152	\$25,001	\$34,660

STANDALONE SKID-MOUNTED FILTRATION PACKAGE WITH 3-VALVE BYPASS (PIPING KIT NOT INCLUDED)

Order ref.	Consult Factory	Consult Factory	Consult Factory
Price (\$)	\$23,886	\$30,919	\$40,469

Price Group 60

OPTIONAL EQUIPMENT

Piping Kit for Filtration Packages	4048575	4048576	4048577	4048578	4048579	4048580
Price (\$)	ON REQUEST					
Dew Point Demand Control	4034925					
Price (\$)	\$2,657					
Δp Filter Alarm with Gauge	4029531					
Price (\$)	\$514					
Valve Position Indicators	4034919					
Price (\$)	\$1,859					
Tower Insulation (indoor only)	4034883	4034889	4034895	4034901	4034907	4034913
Price (\$)	\$4,752	\$5,258	\$6,149	\$6,545	\$7,150	\$7,865

Price Group 63

DRYPOINT® XFi ecoIntelligent Heated Blower Desiccant Dryers

with externally operated blower and 0-3% purge rate using auto-adjusting software and BEKOTOUCH 2 interface

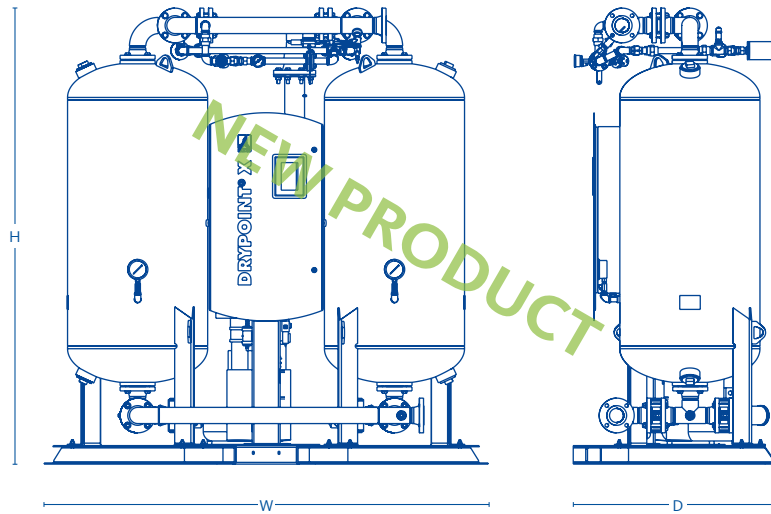

DRYPOINT® XFi	XFi 800	XFi 1000	XFi 1200	XFi 1500	XFi 1800
Connection Size (NPT)	2½" Flange	2½" Flange	3" Flange	3" Flange	4" Flange
Flow Rate (scfm)	800	1000	1200	1500	1800
Dimensions and Weight					
H x W x D (inches)	110 x 95 x 39	111 x 95 x 39	115 x 106 x 47	99 x 106 x 47	118 x 126 x 54
Empty Weight (lbs)	1,815	2,104	2,357	2,526	3,057
Total Fill (lbs)	1,260	1,570	1,890	2,370	2,840

HEATED BLOWER DESICCANT DRYER WITHOUT FILTERS (FILTRATION REQUIRED)

Order ref.	4052644	4052645	4052646	4052647	4052648
Price (\$)	\$75,369	\$83,675	\$88,321	\$100,954	\$107,867

Price Group 60

REQUIRED FILTERS, NOT MOUNTED

	M025	M030	L100
Pre-Filter .01 µm	4020558	4007153	4020750
Price (\$)	\$2,387	\$2,715	\$6,315
Post-Filter 1 µm	4021036	4021037	4032234
Price (\$)	\$2,109	\$2,394	\$5,877

Price Group 82

STANDALONE SKID-MOUNTED FILTRATION PACKAGE (PIPING KIT NOT INCLUDED)

Order ref.	4049687	4049689	4049691
Price (\$)	\$7,575	\$8,469	\$16,426

STANDALONE SKID-MOUNTED FILTRATION PACKAGE WITH 3-VALVE BYPASS (PIPING KIT NOT INCLUDED)

Order ref.	Consult Factory	Consult Factory	Consult Factory
Price (\$)	\$13,040	\$14,520	\$23,371

Price Group 60

OPTIONAL EQUIPMENT

Piping Kit for Filtration Packages	4048570	4048571	4048572	4048573	4048574
Price (\$)	ON REQUEST				
Δp Filter Alarm with Gauge	4029531				
Price (\$)	\$514				
Tower Insulation (indoor only)	4034853	4034859	4034865	4034871	4034877
Price (\$)	\$3,982	\$4,125	\$4,312	\$4,505	\$4,642

Price Group 63

- › Standard outlet pressure dew point: -40 °F
- › Electrical power supply: 460 VAC / 3 Ph / 60 Hz
- › Required pre-filtration grade SX: .01 µm | Required post-filtration grade FX: 1 µm
- › cUL certified controls with NEMA 4 indoor rating
- › Min. / max. inlet air temperature: 40 °F / 120 °F
- › Min. / max. ambient temperature: 40 °F / 120 °F
- › Min. / max. operating pressure: 60 / 150 psig

Maintenance Interval: < 8,000 hours
 Maintenance and Spare Parts: Page 86
 Extended Warranty: Page 144

DRYPOINT® XFI	XFi 2300	XFi 2800	XFi 3300	XFi 4000	XFi 5000	XFi 6000
Connection Size (NPT)	4" Flange	4" Flange	6" Flange	6" Flange	6" Flange	6" Flange
Flow Rate (scfm)	2300	2800	3300	4000	5000	6000
Dimensions and Weight						
H x W x D (inches)	112 x 126 x 54	126 x 126 x 54	121 x 148 x 71	138 x 149 x 71	137 x 192 x 66	136 x 192 x 66
Empty Weight (lbs)	3,698	4,000	5,592	6,468	7,236	7,711
Total Fill (lbs)	3,640	4,390	5,180	6,260	7,820	9,380

HEATED BLOWER DESICCANT DRYER WITHOUT FILTERS (FILTRATION REQUIRED)

Order ref.	4052649	4052650	4052651	4052652	4052653	4052654
Price (\$)	\$123,490	\$139,816	\$176,418	\$193,963	\$222,096	\$256,795

Price Group 60

REQUIRED FILTERS, NOT MOUNTED

	L102	L150	L156
Pre-Filter .01 µm	4020762	4045133	4047776
Price (\$)	\$7,865	\$9,408	\$11,613
Post-Filter 1 µm	4021056	4048944	4021058
Price (\$)	\$7,410	\$8,950	\$11,155

Price Group 82

STANDALONE SKID-MOUNTED FILTRATION PACKAGE (PIPING KIT NOT INCLUDED)

Order ref.	4049693	4049695	4049697
Price (\$)	\$21,152	\$25,001	\$34,660

STANDALONE SKID-MOUNTED FILTRATION PACKAGE WITH 3-VALVE BYPASS (PIPING KIT NOT INCLUDED)

Order ref.	Consult Factory	Consult Factory	Consult Factory
Price (\$)	\$23,886	\$30,919	\$40,469

Price Group 60

OPTIONAL EQUIPMENT

Piping Kit for Filtration Packages	4048575	4048576	4048577	4048578	4048579	4048580
Price (\$)	ON REQUEST					
Δp Filter Alarm with Gauge	4029531					
Price (\$)	\$514					
Tower Insulation (indoor only)	4034883	4034889	4034895	4034901	4034907	4034913
Price (\$)	\$4,752	\$5,258	\$6,149	\$6,545	\$7,150	\$7,865

Price Group 63

DRYPOINT® ACH Heated Purge Desiccant Dryer

with external heated purge and standard PLC controller

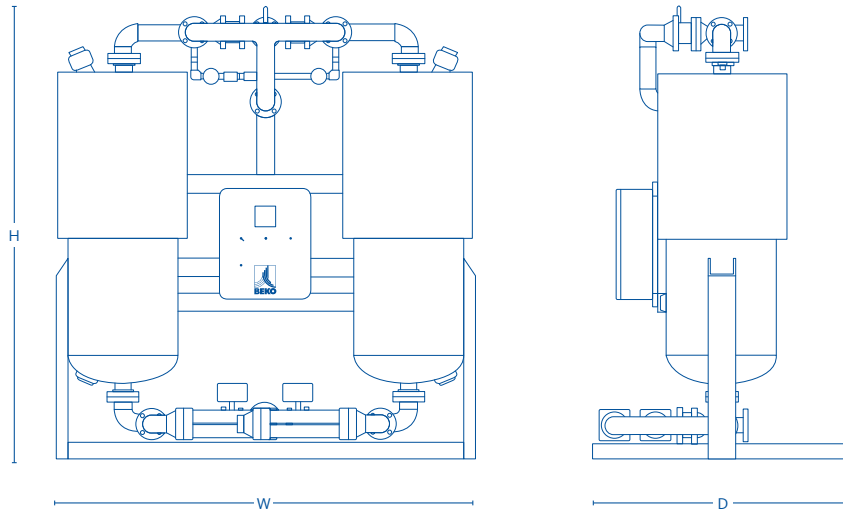

DRYPOINT® ACH	ACH 70	ACH 130	ACH 180	ACH 260	ACH 355	ACH 460	ACH 575
Connection Size (NPT)	¾"	1"	1½"	1½"	1½"	2"	2"
Flow Rate (scfm)	70	130	180	260	355	460	575
Dimensions and Weight							
H x W x D (inches)	72 x 50 x 22	72 x 54 x 24	90 x 54 x 30	90 x 58 x 30	92 x 62 x 26	96 x 70 x 42	96 x 72 x 30
Empty Weight (lbs)	475	600	700	1,078	1,225	1,372	1,764
Total Fill (lbs)	100	180	250	360	490	640	800

HEATED PURGE DRYER WITHOUT TOWER INSULATION (FILTRATION REQUIRED)

Order ref.	4012470	4012471	4012472	4012473	4012474	4012475	4012476
Price (\$)	\$21,175	\$21,687	\$25,439	\$26,278	\$27,648	\$31,127	\$36,222

HEATED PURGE DRYER WITHOUT TOWER INSULATION, MOUNTED FILTERS AND BYPASS

Order ref.	Consult Factory						
Price (\$)	\$21,677	\$23,415	\$28,402	\$29,867	\$32,218	\$36,816	\$42,433

HEATED PURGE DRYER WITH TOWER INSULATION

Order ref.	4022756	4022757	4022758	4022759	4022528	4022760	4022761
Price (\$)	\$23,875	\$24,364	\$27,408	\$29,101	\$31,337	\$35,227	\$41,142

HEATED PURGE DRYER WITH TOWER INSULATION, MOUNTED FILTERS AND BYPASS

Order ref.	Consult Factory						
Price (\$)	\$25,723	\$27,034	\$30,668	\$33,556	\$35,907	\$40,915	\$47,354

Price Group 60

REQUIRED FILTERS, NOT MOUNTED

	S075	S100	M012	M015	M018	M020	M022
Pre-Filter .01 µm	4002953	4020384	4002955	4002956	4002957	4002958	4002959
Price (\$)	\$374	\$409	\$494	\$702	\$778	\$972	\$1,082
Post-Filter 1 µm	4021029	4021030	4024402	4021032	4021033	4007876	4021034
Price (\$)	\$374	\$409	\$494	\$702	\$778	\$972	\$1,082

Price Group 82

OPTIONAL EQUIPMENT

Dew Point Demand System	4021017
Price (\$)	\$3,460

Price Group 63

Drain Upgrade to BEKOMAT®	4047670
Price (\$)	\$391

Price Group 12

- › Standard outlet pressure dew point: -40 °F
- › Optional outlet pressure dew point: -100 °F
- › Electrical power supply: 460 VAC / 3 Ph / 60 Hz (ACH 70, 130: 120 VAC / 1 Ph / 60 Hz)
- › Required pre-filtration grade SX: .01 µm | Required post-filtration grade FX: 1 µm
- › NEMA 4 indoor
- › Min. / max. inlet air temperature: 40 °F / 120 °F
- › Min. / max. ambient temperature: 40 °F / 120 °F
- › Min. / max. operating pressure: 60 / 150 psig
- › Optional operating pressure: 250 psig

Maintenance Interval: < 8,000 hours
 Maintenance and Spare Parts: Page 89
 Extended Warranty: Page 144

DRYPOINT® ACH	ACH 720	ACH 1010	ACH 1300	ACH 1725	ACH 2350	ACH 3250	ACH 4050
Connection Size (NPT)	2½"	3" Flange	3" Flange	4" Flange	4" Flange	6" Flange	6" Flange
Flow Rate (scfm)	720	1010	1300	1725	2350	3250	4050
Dimensions and Weight							
H x W x D (inches)	96 x 90 x 38	96 x 96 x 42	108 x 96 x 56	112 x 104 x 48	120 x 120 x 54	120 x 144 x 56	120 x 144 x 60
Empty Weight (lbs)	2,352	4,704	5,390	6,272	8,036	11,760	12,740
Total Fill (lbs)	1,000	1,400	1,800	2,400	3,300	4,500	5,600

HEATED PURGE DRYER WITHOUT TOWER INSULATION (FILTRATION REQUIRED)

Order ref.	4012477	4012478	4012479	4012480	4012481	4012482	4012483
Price (\$)	\$42,705	\$50,657	\$60,192	\$75,872	\$83,704	\$123,100	\$149,865

HEATED PURGE DRYER WITHOUT TOWER INSULATION, MOUNTED FILTERS AND BYPASS

Order ref.	Consult Factory						
Price (\$)	\$53,369	\$63,808	\$77,040	\$104,655	\$117,881	\$159,163	\$184,050

HEATED PURGE DRYER WITH TOWER INSULATION

Order ref.	4022762	4022763	4022764	4022765	4022766	4022767	4022768
Price (\$)	\$47,931	\$56,194	\$66,550	\$82,225	\$89,698	\$129,654	\$155,980

HEATED PURGE DRYER WITH TOWER INSULATION, MOUNTED FILTERS AND BYPASS

Order ref.	Consult Factory						
Price (\$)	\$58,596	\$66,859	\$83,398	\$111,009	\$122,134	\$162,152	\$194,500

Price Group 60

REQUIRED FILTERS, NOT MOUNTED

	M025	M030	L100	L102	L150	L156
Pre-Filter .01 µm	4002961	4002963	4020750	4020762	4045133	4047776
Price (\$)	\$2,109	\$2,394	\$6,315	\$7,865	\$9,408	\$11,613
Post-Filter 1 µm	4021036	4021037	4032234	4021056	4048944	4021058
Price (\$)	\$2,109	\$2,394	\$5,877	\$7,410	\$8,950	\$11,155

Price Group 82

OPTIONAL EQUIPMENT

Dew Point Demand System	4021017
Price (\$)	\$3,460

Price Group 63

Drain Upgrade to BEKOMAT®	4047670	-
Price (\$)	\$391	-

Price Group 12

DRYPOINT® AC HP Heatless High Pressure Desiccant Dryers

full stainless steel components with PLC controller

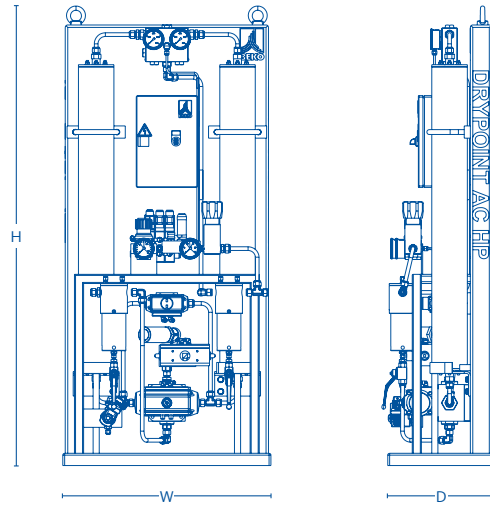

DRYPOINT® AC HP	AC 60 HP 100	AC 90 HP 100	AC 160 HP 100	AC 250 HP 100	AC 390 HP 100	AC 110 HP 250	AC 145 HP 250	AC 210 HP 250
Connection Size (NPT)	½"	½"	½"	½"	½"	½"	½"	½"
Flow Rate (scfm)	35	50	95	145	230	65	85	125
Max. Pressure (psig)	1450	1450	1450	1450	1450	3600	3600	3600

Dimensions and Weight

H x W x D (inches)	57 x 31 x 18	59 x 31 x 18	59 x 31 x 18	70 x 31 x 18	70 x 33 x 20	53 x 31 x 18	53 x 31 x 18	66 x 31 x 18
Weight (lbs)	350	350	400	550	570	460	485	540

Price (\$)	ON REQUEST							
-------------------	-------------------	--	--	--	--	--	--	--

Price Group 61

OPTIONAL EQUIPMENT

Purge Air Heater	Consult Factory
Price (\$)	\$4,406
Shock Proofing	Consult Factory
Price (\$)	ON REQUEST
Needle Valve (manual drain)	Consult Factory
Price (\$)	\$816
Auto Drain 115 V / 60 Hz with Timer	4024797
Price (\$)	\$2,410
Vibration Dampening Pads	4034084
Price (\$)	\$269

Price Group 63

- › Standard pressure dew point: -40 °F
- › Optional outlet pressure dew point: -100 °F
- › Vessels and all components are stainless steel
- › Optional pressure approvals: on request
- › Shock and vibration proof systems: on request
- › External low pressure purge attachment: on request
- › Standard electrical power supply: 85 - 265 VAC; 24 Vdc; 50-60 Hz
- › Included pre-filtration grade SX: .01 µm
- › Optional pre-filtration grade FX: 1 µm
- › Included post-filtration grade FX: 1 µm
- › Min. / max. air inlet temperature: 41 °F / 131 °F
- › Min. / max. ambient temperature: 41°F / 122°F

Maintenance Interval: < 8,000 hours
Maintenance and Spare Parts: Page 91
Extended Warranty: Page 144

DRYPOINT® AC HP	AC 440 HP 250	AC 655 HP 250	AC 145 HP 350	AC 190 HP 350	AC 265 HP 350	AC 540 HP 350	AC 820 HP 350
Connection Size	½"	½"	½"	½"	½"	½"	½"
Flow Rate (scfm)	260	385	85	110	155	315	480
Max. Pressure (psig)	3600	3600	5000	5000	5000	5000	5000

Dimensions and Weight

H x W x D (inches)	66 x 31 x 18	70 x 33 x 20	53 x 31 x 18	53 x 31 x 18	66 x 31 x 18	66 x 31 x 18	70 x 33 x 20
Weight (lbs)	620	680	460	485	540	620	680

Price (\$)	ON REQUEST						
-------------------	-------------------	--	--	--	--	--	--

Price Group 61

OPTIONAL EQUIPMENT

Purge Air Heater	Consult Factory
Price (\$)	\$4,406
Shock Proofing	Consult Factory
Price (\$)	ON REQUEST
Needle Valve (manual drain)	Consult Factory
Price (\$)	\$816
Auto Drain 115 V / 60 Hz with Timer	4024797
Price (\$)	\$2,410
Vibration Dampening Pads	4034084
Price (\$)	\$269

Price Group 63

DRYPOINT® X Maintenance

■ for all XCe and XCp series desiccant dryers

Maintenance Interval: 8,000 hours

DRYPOINT® X	XCe/XCp 80	XCe/XCp 100	XCe/XCp 120	XCe/XCp 160	XCe/XCp 200	XCe/XCp 250	XCe/XCp 300	XCe/XCp 400	XCe/XCp 500
Complete Exhaust Silencer	4020833	4020834	4020833 x 2	4020835		4020836	4026420 x 2		4020835 x 2
Price (\$)	\$100	\$116	\$100 ea.	\$212		\$254	\$122 ea.		\$212 ea.

Price Group 63

Replacement Element Pre-Filter (0.1 µm)	4038113		4038149	4038114	4038115	4038150	4038151		
Price (\$)	\$142		\$169	\$217	\$235	\$271	\$323		
Replacement Element Post-Filter (1 µm)	4038106		4038140	4038107	4038108	4038141	4038142		
Price (\$)	\$142		\$169	\$217	\$235	\$271	\$323		

Price Group 86

Float Drain Maintenance Kit	4025536								
Price (\$)	\$96								

Price Group 84

BEKOMAT® 31 Service Unit	4023608								
Price (\$)	\$141								
BEKOMAT® 32 Service Unit	4025061								
Price (\$)	\$167								

Price Group 13

DRYPOINT® X	XCe/XCp 650	XCe/XCp 800	XCp 1000	XCp 1200	XCp 1500	XCp 1900	XCp 2300	XCp 2800
Exhaust Silencer Element	-		4029620 x 8		4029621 x 8			
Price (\$)	-		\$115 ea.		\$151 ea.			
Complete Exhaust Silencer	4020836 x 2		4044005 x 2		4044006 x 2			
Price (\$)	\$254 ea.		\$685 ea.		\$780 ea.			
Butterfly Valve Disc Seal Kit	-		4032037 x 4		4032038 x 4		4032039 x 4	
Price (\$)	-		\$70		\$91		\$115	

Price Group 63

Replacement Element Pre-Filter (0.1 µm)	4038116		4038154	4038155	4038156	4038117 x 3		
Price (\$)	\$453		\$511	\$760	\$855	\$1,269		
Replacement Element Post-Filter (1 µm)	4038109		4038145	4038146	4038147	4038110 x 3		
Price (\$)	\$453		\$511	\$760	\$855	\$1,269		

Price Group 86

Float Drain Maintenance Kit	4025536								
Price (\$)	\$96								

Price Group 84

BEKOMAT® 31 Service Unit	4023608								
Price (\$)	\$141								
BEKOMAT® 32 Service Unit	4025061								
Price (\$)	\$167								

Price Group 13

DRYPOINT® X Maintenance

- for all XCe and XCp series desiccant dryers

Maintenance Interval: 16,000 hours

DRYPOINT® X	XCe/XCp 80	XCe/XCp 100	XCe/XCp 120	XCe/XCp 160	XCe/XCp 200	XCe/XCp 250	XCe/XCp 300	XCe/XCp 400	XCe/XCp 500	XCe/XCp 650	XCe/XCp 800
Inlet Valve Actuator	4027892	4027893		4027894		4027895		4027896		4027897	
Price (\$)	\$276	\$297		\$378		\$396		\$740		\$896	
Exhaust Valve	4020800			4020802		4026416			4020804		4020806
Price (\$)	\$254			\$273		\$355			\$357		\$379
Exhaust Valve Actuator	4027887			4027888		4027889		4027890		4027891	
Price (\$)	\$180			\$215		\$290		\$240		\$338	
¾" Valve Service Seal Kit	4027898										
Price (\$)	\$17										
1" Valve Service Seal Kit	4027899										
Price (\$)	\$20										
1¼" Valve Service Seal Kit	4027900										
Price (\$)	\$36										
1½" Valve Service Seal Kit	4027901										
Price (\$)	\$42										
2" Valve Service Seal Kit	4027902										
Price (\$)	\$57										
2½" Valve Service Seal Kit	4027903										
Price (\$)	\$132										

Price Group 63

- activated alumina desiccant filling material

Maintenance Interval: 24,000 hours

DRYPOINT® X	XCe/XCp 80	XCe/XCp 100	XCe/XCp 120	XCe/XCp 160	XCe/XCp 200	XCe/XCp 250	XCe/XCp 300	XCe/XCp 400
Order ref. ½" diameter	4027023	4027023	4027023	4027023	4027023	4027022	4027022	4027022
Unit of Measure	25 lb bag					Bulk weight lb		
Order qty.	4	6	6	10	10	384	384	539
Price (\$)	\$500	\$750	\$750	\$1,250	\$1,250	\$1,536	\$1,536	\$2,156

Price Group 63

DRYPOINT® X	XCe/XCp 500	XCe/XCp 650	XCe/XCp 800	XCp 1000	XCp 1200	XCp 1500	XCp 1900	XCp 2300	XCp 2800
Order ref. ½" diameter	4027022	4027022	4027022	4027022	4027022	4027022	4027022	4027022	4027022
Unit of Measure	Bulk weight lb								
Order qty.	715	917	1114	1120	1355	1840	2110	3125	3125
Price (\$)	\$2,860	\$3,668	\$4,456	\$4,480	\$5,420	\$7,360	\$8,440	\$12,500	\$12,500

Price Group 63

DRYPOINT® X Spare Parts

- standard replacement components for XCe and XCp series desiccant dryers

DRYPOINT® X	XCe/XCp 80	XCe/XCp 100	XCe/XCp 120	XCe/XCp 160	XCe/XCp 200	XCe/XCp 250	XCe/XCp 300	XCe/XCp 400	XCe/XCp 500	XCe/XCp 650	XCe/XCp 800
Outlet Check Valve	4020820	4020822		4026421		4020821		4020823		4020816	
Price (\$)	\$35	\$44		\$67		\$97		\$135		\$297	
Pressure Relief Safety Valve	4026666			4026667		4026668			4026669		
Price (\$)	\$50			\$73		\$133			\$444		
Complete Dryer Inlet Valve	4020801	4020803		4026417		4020805		4020807		4032458	
Price (\$)	\$274	\$301		\$345		\$395		\$763		\$810	
Complete Dryer Exhaust Valve	4020800			4020802		4026416			4020804		4020806
Price (\$)	\$254			\$273		\$355			\$357		\$379
Purge Flow Control Valve	4020764				4020765			4020766			
Price (\$)	\$96				\$132			\$242			

DRYPOINT® X	XCp 1000	XCp 1200	XCp 1500	XCp 1900	XCp 2300	XCp 2800
Outlet Check Valve	4029374		4029375			4029376
Price (\$)	\$356		\$399			\$554
Pressure Relief Safety Valve	4026669	4026670		4026671		4026672
Price (\$)	\$444	\$545		\$639		\$837
Purge Flow Control Valve	4032820		4032819			4032822
Price (\$)	\$53		\$78			\$103
Complete Exhaust Silencer	4044005 x 2			4044006 x 2		
Price (\$)	\$685 ea.			\$780 ea.		

Price Group 63

Standardized Replacement Parts	Order ref.	Price (\$)
BEKOMINI Controller for All XCe Models	4026540	\$446
BEKOTOUCH Controller for All XCp Models	4052559	\$677
BEKOTOUCH Display Screen for All XCp Models	4052560	\$1,165
Complete Solenoid Valve Assembly for XCe/XCp 80-800	4024046	\$611
Complete Solenoid Valve Assembly for XCp 1000-2800	4029193	\$1,029
2½" 0-160 psig Pressure Gauge for All XCe Models	4026663	\$24
2½" 0-160 psig Pressure Gauge for All XCp Models	4026664	\$42
Complete Humidity Sensor Assembly for All XCp Models	4027695	\$317
Gauge Clamp for All XCp Models	4026665	\$12
¼" 20-130 psig Filter Regulator Combo for All XCe/XCp Models	4026419	\$113
Filter Element for Filter Regulator Combo	4038241	\$6
Replacement Brass Cone Silencer for All XCe/XCp Models	4026418	\$9
Replacement On/Off Switch for XCp 80-2800	4029399	\$104
Replacement Speed Control for All XCe/XCp Models	4027427	\$29

Always refer to the installation and operating manual supplied with the dryer being serviced

Price Group 63

- replacement desiccant filling material

Replacement Activated Alumina (25 lb. bags)		
¾" (other varieties available on request)		
All models and fill weights	4027023	\$125 ea.
Replacement Activated Alumina (bulk material)		
¾" (other varieties available on request)		
For fill weights of 300+ lbs	4027022	\$4 per lb

Price Group 63

DRYPOINT® ACH Maintenance

■ for all ACH series desiccant dryers

Maintenance Interval: 8,000 hours

DRYPOINT® ACH	ACH 70	ACH 130	ACH 180	ACH 260	ACH 355	ACH 460	ACH 575	ACH 720	ACH 1010	ACH 1300	ACH 1725	ACH 2350	ACH 3250	ACH 4050
Replacement Element Pre-Filter (.01 µm)	4038112	4038113	4038149	4038114	4038115	4038150	4038151	4038152	4038153	4038116	4038117 x 2	4038117 x 3	4038117 x 4	4038117 x 7
Price (\$)	\$134	\$142	\$169	\$217	\$235	\$271	\$323	\$358	\$417	\$453	\$846	\$1,269	\$1,692	\$2,961
Replacement Element Post-Filter (1 µm)	4038105	4038106	4038140	4038107	4038108	4038141	4038142	4038143	4038144	4038109	4038110 x 2	4038110 x 3	4038110 x 4	4038110 x 7
Price (\$)	\$134	\$142	\$169	\$217	\$235	\$271	\$323	\$358	\$417	\$453	\$846	\$1,269	\$1,692	\$2,961

Price Group 86

1/8" Activated Alumina (25 lb bags)	4027023 x 4	4027023 x 8	4027023 x 10	4027023 x 16	4027023 x 20	4027023 x 26	4027023 x 32	4027023 x 40	4027023 x 56	4027023 x 72	4027023 x 96	4027023 x 132	4027023 x 180	4027023 x 224
Weight in lbs	100	180	250	360	490	640	800	1,000	1,400	1,800	2,400	3,300	4,500	5,600
Price (\$)	\$500	\$1,000	\$1,250	\$2,000	\$2,500	\$3,328	\$4,000	\$5,000	\$7,000	\$9,000	\$12,000	\$16,500	\$22,500	\$28,000

Price Group 63

DRYPOINT® ACH Spare Parts

■ replacement desiccant filling material

Replacement Activated Alumina (25 lb bags)		
1/8" (other varieties available on request)		
All models and fill weights	4027023	\$125 ea.

Replacement Activated Alumina (bulk material)		
1/8" (other varieties available on request)		
For fill weights of 300+ lbs	4027022	\$4 per lb

Price Group 63

DRYPOINT® ACC Maintenance

■ complete maintenance kits and spare parts

Maintenance Interval: see below

ACC 4 - 35 for all model years and ACC 45 - 105 up to model year 2021

Dryer Model	Annual Maintenance				Maintenance Kit A				Maintenance Kit B			
	with Float Drain		with BEKOMAT®		with Float Drain		with BEKOMAT®		with Float Drain		with BEKOMAT®	
	Order ref.	Price (\$)	Order ref.	Price (\$)	Order ref.	Price (\$)	Order ref.	Price (\$)	Order ref.	Price (\$)	Order ref.	Price (\$)
ACC 4	4048821	\$230	4022723	\$230	4048826	\$452	4023687	\$478	4048843	\$1,370	4023705	\$1,370
ACC 6					4048827	\$530	4023688	\$535	4048844	\$1,442	4023706	\$1,442
ACC 8					4048828	\$558	4023689	\$588	4048845	\$1,498	4023707	\$1,498
ACC 10					4048829	\$678	4023690	\$688	4048846	\$1,620	4023708	\$1,620
ACC 15					4048830	\$828	4023691	\$834	4048847	\$1,769	4023709	\$1,769
ACC 25					4048831	\$928	4023692	\$928	4048848	\$1,870	4023710	\$1,870
ACC 35					4048832	\$1,250	4023693	\$1,250	4048849	\$2,190	4023711	\$2,190
ACC 45	4048822	\$269	4022724	\$269	4048833	\$1,356	4023694	\$1,356	4048850	\$2,711	4023712	\$2,711
ACC 55					4048834	\$1,463	4023695	\$1,463	4048851	\$2,817	4023713	\$2,817
ACC 65					4048835	\$1,641	4023696	\$1,641	4048852	\$2,995	4023714	\$2,995
ACC 85					4048836	\$1,855	4023697	\$1,855	4048853	\$3,210	4023715	\$3,210
ACC 105	4048823	\$288	4022725	\$288	4048837	\$2,283	4023698	\$2,283	4048854	\$3,637	4023716	\$3,637

ACC 46 - 110 for model year 2022 and newer

Dryer Model	Annual Maintenance				Maintenance Kit A				Maintenance Kit B			
	with Float Drain		with BEKOMAT®		with Float Drain		with BEKOMAT®		with Float Drain		with BEKOMAT®	
	Order ref.	Price (\$)	Order ref.	Price (\$)	Order ref.	Price (\$)	Order ref.	Price (\$)	Order ref.	Price (\$)	Order ref.	Price (\$)
ACC 46	4056917	\$315	4056919	\$349	4056951	\$1,865	4056973	\$1,915	4056968	\$3,296	4056978	\$3,307
ACC 56					4056964	\$1,992	4056974	\$1,980	4056969	\$3,498	4056979	\$3,489
ACC 75					4056965	\$2,228	4056975	\$2,175	4056970	\$3,667	4056980	\$3,697
ACC 90	4056918	\$388	4056920	\$425	4056966	\$2,441	4056976	\$2,444	4056971	\$3,837	4056981	\$3,941
ACC 110					4056967	\$2,953	4056977	\$2,994	4056972	\$4,306	4056982	\$4,466

Price Group 69

Annual Maintenance (1-year) Kit includes: pre-filter replacement element and drain service kit.

Maintenance Kit A (2-year) includes: all components in the 1-year kit plus desiccant cartridges, pre-filter replacement element, drain service kit, sealing o-rings with washers and service manual.

Maintenance Kit B (4-year) includes: all components in the 1-year and 2-year kits plus a complete valve service kit and service manual.

NOTE: preventative maintenance is to be performed at intervals of 1-year, 2-years and 4-years or 6,000, 12,000 and 24,000 hours- whichever comes first.

DRYPOINT® ACC	Order ref.	Price (\$)
Valve Service Kit for ACC 4 - 35 - all model years	4022889	\$932
Valve Service Kit for ACC 45 - 175 - up to model year 2021	4022890	\$1,342
Solenoid Valve Kit for ACC 46 - 110 - model year 2022 and newer	4054051	\$1,506
Shuttle Valve Kit for ACC 4 - 35 - all model years	4035867	\$131
Shuttle Valve Kit for ACC 45 - 175 - up to model year 2021	4035868	\$301
Shuttle Valve Kit for ACC 46 - 110 - model year 2022 and newer	4054050	\$301
Silencer for ACC 4 - all model years	4056245	\$165
Silencer for ACC 6 - 35 - all model years	4035863	\$165
Silencer for ACC 45 - 85 - up to model year 2021	4035864	\$363
Silencer for ACC 46 - 90 - model year 2022 and newer	4054049	\$363
Silencer for ACC 105 - 175 - up to model year 2021	4035865	\$543
Silencer for ACC 110 - 180 - model year 2022 and newer	4055292	\$543
Diaphragm Kit Top for ACC 4 - 35 - all model years	4022206	\$184
Diaphragm Kit Bottom for ACC 4 - 35 - all model years	4022208	\$184
Master Seal Kit for ACC 46 - 110 - model year 2022 and newer	4054053	\$184
Controller for ACC 4 - 35 - all model years	4027273	\$1,408
Controller for ACC 45 - 365 - up to model year 2021	4027027	\$2,213
Controller with Valves for ACC 46 - 110 - model year 2022 and newer	4054052	\$2,785

Price Group 69

DRYPOINT® AC HP Maintenance

■ replacement filter elements, maintenance parts, and select spare parts

Maintenance Interval: < 8,000 hours

Filter Housing	CX 25 µm	FX 1 µm	SX .01 µm	A .003 ppm	Price (\$)
HP100S040	4007820	4007822	4007823	4007824	\$307
HP100S045	4007827	4007829	4007830	4007831	\$396
HP100S050	4007835	4007839	4007841	4007843	\$497
HP100S055	4007836	4007840	4007842	4007844	\$585
HP100S075	4007849	4007853	4007855	4007857	\$654
HP100M010	4007850	4007854	4007856	4007858	\$756
HP100M015	4007863	4007867	4007869	4007871	\$833
HP100M020	4007864	4007868	4007870	4007872	\$1,130
HP350S030	4007820	4007822	4007823	4007824	\$307
HP350S040	4007827	4007829	4007830	4007831	\$396
HP350S045	4007835	4007839	4007841	4007843	\$497
HP350S050	4007836	4007840	4007842	4007844	\$585
HP350S075	4007849	4007853	4007855	4007857	\$654
HP350M010	4007850	4007854	4007856	4007858	\$756
HP350M012	4007863	4007867	4007869	4007871	\$833
HP350M015	4007864	4007868	4007870	4007872	\$1,130

Price Group 84

Maintenance Interval: see manual

Maintenance Parts	Installation Location (diagram in manual)	Order ref.	Price (\$)
1" Standard Silencer	X11	4016160	\$405
1" Low-noise Silencer	X11A	4016161	\$212
Safety Valve	S3	4016162	\$87
Water Resistant Desiccant per 2 lbs	-	4016163	\$119
Water Resistant Desiccant per 7 lbs	-	4016164	\$354
Molecular Sieve Desiccant per 2 lbs	-	4016165	\$162
Molecular Sieve Desiccant per 9 lbs	-	4016166	\$639
Sealing Kit (non-return valve)	-	4022984	\$500

Price Group 63

Select Spare Parts	Installation Location on Diagram in Manual	Order ref.	Price (\$)
Changeover Valve	V1/2	4016144	\$9,019
Pressure Build-up Valve	V3	4016145	\$5,105
Pressure Release Valve	V4	4016146	\$5,599
Complete Valve Set	V1-V4, R1-R4	4016147	\$24,291
Non-return Valve Block	R1-R4	4016149	\$4,583
Non-return Valve	R5	4016148	\$317
Pressure Controller (up to 6,092 psig)	X13	4016150	\$5,271
Second Stage Pressure Reducer	X2	4016151	\$366
Pneumatic Pilot Valves	Y1-Y4	4058176	\$1,808
Needle Valve (manual drain)	H3-H5	4016153	\$404
Pressure Gauge 0-232 psig	PI 1.4	4016154	\$117
Pressure Gauge 0-375 psig	PI 1.3	4016155	\$117
Pressure Gauge 0-4,351 psig	PI 1.1/1.2	4016156	\$117
Pressure Gauge 0-5,800 psig	PI 1.1/1.2	4016157	\$117
Pressure Gauge 0-8,700 psig	PI 1.1/1.2	4016158	\$335
Auto Drain (5,076 psig, 15 V without cable)	-	4024797	\$2,410
Vessel Sieve	X5	4016159	\$411
Adapter for Vessel Ø12mm/116m	-	4024859	\$411
Sealing Kit for ½" Vessel	-	4024858	\$105
Electronic Control Unit 24 VDC	-	XE ACHP 26400	\$3,403
Electronic Control Unit 230 VAC	-	XE ACHP 26405	\$4,032

Price Group 63

Membrane Drying



DRYPOINT® MD

space saving compressed air membrane dryers

- › MDe economy membrane air dryers
- › MDp premium membrane air dryers with integrated pre-filtration
- › FDR filter, membrane air dryer, regulator packages
- › MDi ecoIntelligent membrane air dryers

DRYPOINT® MD Product Selector Chart

product sizing table for MDe, MDp and FDR series membrane air dryers

Inlet Pressure Dew Point (PDP)		Desired Outlet PDP Result Based on Nearest Inlet PDP Parameter			
40 °F	with refrigerant drying	26 °F	0 °F	-30 °F	-40 °F
100 °F	without refrigerant drying	70 °F	35 °F	-4 °F	-20 °F

Model Selector	Flow Rate (scfm)							
	Inlet	Outlet	Inlet	Outlet	Inlet	Outlet	Inlet	Outlet
MDe 2, MDp 2 and FDR 2	2.09	1.92	.98	.81	.64	.47	.58	.42
MDe 4, MDp 4 and FDR 4	4.18	3.83	2.07	1.72	1.44	1.09	1.33	.96
MDe 6, MDp 6 and FDR 6	6.27	5.75	3.10	2.58	2.15	1.63	2.00	1.44
MDe 8, MDp 8 and FDR 8	8.36	7.67	4.13	3.43	2.87	2.17	2.63	1.89
MDe 10, MDp 10 and FDR 10	11.34	10.29	5.70	4.66	4.10	3.05	3.85	2.77
MDe 12, MDp 12 and FDR 12	12.55	11.50	6.20	5.15	4.31	3.26	3.89	2.81
MDe 17, MDp 17 and FDR 17	16.73	15.33	8.25	6.85	5.75	4.35	5.17	3.76
MDe 25 and MDp 25	25.09	23.00	12.41	10.31	8.63	6.53	7.94	5.69
MDe 35 and MDp 35	33.46	30.66	16.53	13.74	11.50	8.70	10.51	7.56
MDe 45 and MDp 45	43.29	39.09	24.24	20.05	17.25	13.06	15.97	11.52
MDe 55 and MDp 55	55.89	50.64	28.92	23.68	20.65	15.40	19.08	13.68
MDe 65 and MDp 65	67.21	60.81	35.49	29.09	25.21	18.81	23.56	16.92
MDe 100 and MDp 100	100.77	91.37	53.26	43.85	37.86	28.46	35.33	25.42
MDe 130 and MDp 130	134.35	121.78	71.00	58.41	50.48	37.90	46.79	33.70

Correction Factors

Operating Pressure (psig)	40	50	60	70	80	90	100	110	120	130	140	150	160	170	180
Correction Factor	0.22	0.32	0.42	0.54	0.68	0.83	1.00	1.13	1.26	1.40	1.55	1.70	1.87	2.03	2.19

The correction factors on this page provide an estimation of the performance that can be achieved with the model sizes shown. For precise sizing for your application, please contact your BEKO Technologies sales representative.

DRYPOINT® MDe Economy Series Membrane Dryers

standard membrane air dryer with tubular or filter style housing

- › Required pre-filtration: 5 µm (MDe 2-8) or .01 µm (MDe 10-130)
- › Min. ambient air temperature: 34 °F
- › Max. standard operating temperature: 130 °F
- › Max. standard operating pressure: 140 psig
- › Max. optional operating temperature: 160 °F
- › Max. optional operating pressure: 232 psig

Maintenance Interval: 8,000 hours
 Maintenance and Spare Parts: Page 101
 Extended Warranty: Page 144

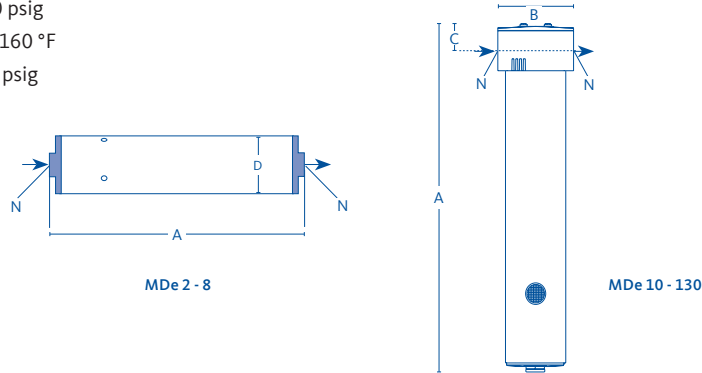

DRYPOINT® MDe	MDe 2	MDe 4	MDe 6	MDe 8	MDe 10	MDe 12	MDe 17
Connection Size (NPT)	¼"	¼"	¼"	¼"	¾"	¾"	¾"
Inlet Flow Rate (scfm)	2.09	4.18	6.27	8.36	11.34	12.55	16.73
Installation Orientation and Housing Design	Horizontal Tubular Style	Horizontal Tubular Style	Horizontal Tubular Style	Horizontal Tubular Style	Vertical Filter Style	Vertical Filter Style	Vertical Filter Style
Dimensions and Weight							
A x B x C (inches)	5.51	7.48	9.06	11.42	13.34 x 2.95 x 1.10	16.10 x 2.95 x 1.10	18.46 x 2.95 x 1.10
D (inches)	ø1.77	ø1.77	ø1.77	ø1.77	-	-	-
Weight (lbs)	0.60	0.77	0.90	1.08	4.08	4.58	4.97

Order ref.	4041398	4006052	4006071	4006055	4016246	4006056	4041399
Price (\$)	\$672	\$766	\$870	\$965	\$1,078	\$1,078	\$1,197
Optional Operating Temperature and Pressure AP	Factory installed option - please add AP suffix to order reference number (Example: 4016246-AP)						
Price (\$)	ON REQUEST						

Price Group 70

REQUIRED PRE-FILTRATION

	KN Series	S040
Pre-Filter 5 µm or .01 µm	4011323 (5 µm)	4002950 (.01 µm)
Price (\$)	\$177	\$234

Price Group 82

DRYPOINT® MDe	MDe 25	MDe 35	MDe 45	MDe 55	MDe 65	MDe 100	MDe 130
Connection Size (NPT)	¾"	¾"	¾"	¾"	1½"	1½"	1½"
Inlet Flow Rate (scfm)	25.09	33.46	43.29	55.89	67.21	100.77	134.35
Installation Orientation and Housing Design	Vertical Filter Style	Vertical Filter Style	Vertical Filter Style	Vertical Filter Style	Vertical Filter Style	Vertical Filter Style	Vertical Filter Style
Dimensions and Weight							
A x B x C (inches)	18.98 x 3.94 x 1.34	20.95 x 3.94 x 1.34	23.70 x 3.94 x 1.34	26.46 x 3.94 x 1.34	23.20 x 5.74 x 1.89	28.30 x 5.74 x 1.89	34.60 x 5.74 x 1.89
D (inches)	-	-	-	-	-	-	-
Weight (lbs)	7.66	8.38	8.99	9.64	17.14	19.56	22.00

Order ref.	4006062	4006065	4006068	4010491	4011371	4011369	4011091
Price (\$)	\$1,473	\$1,645	\$1,828	\$1,959	\$3,858	\$5,185	\$6,807
Optional Operating Temperature and Pressure AP	Factory installed option - please add AP suffix to order reference number (Example: 40xxxxx-AP)						
Price (\$)	ON REQUEST						

Price Group 70

REQUIRED PRE-FILTRATION

	S045	S050	S055	S075	S100
Pre-Filter .01 µm	4020231	4002951	4002952	4002953	4020384
Price (\$)	\$250	\$278	\$328	\$374	\$409

Price Group 82

DRYPOINT® MDp Premium Series Membrane Dryers

membrane air dryer with integrated pre-filter

- › Integrated pre-filtration: .01 µm
- › Recommended pre-filtration: 1 or 5 µm
- › Min. ambient air temperature: 34 °F
- › Max. standard operating temperature: 130 °F
- › Max. standard operating pressure: 140 psig
- › Max. optional operating temperature: 160 °F
- › Max. optional operating pressure: 232 psig

Maintenance Interval: 8,000 hours
 Maintenance and Spare Parts: Page 101
 Extended Warranty: Page 144

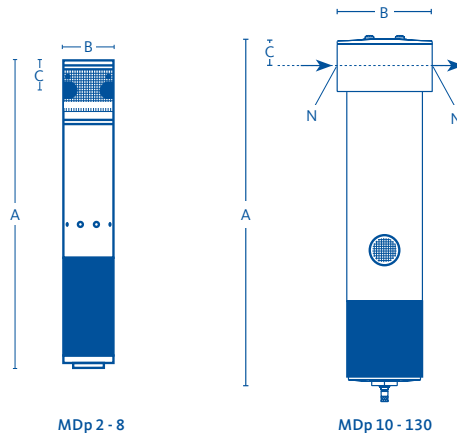

DRYPOINT® MDp	MDp 2	MDp 4	MDp 6	MDp 8	MDp 10	MDp 12	MDp 17
Connection Size (NPT)	¼"	¼"	¼"	¼"	¾"	¾"	¾"
Inlet Flow Rate (scfm)	2.09	4.18	6.27	8.36	11.34	12.55	16.73

Dimensions and Weight

A x B x C (inches)	10.43 x 1.81 x 1.06	12.40 x 1.81 x 1.06	13.98 x 1.81 x 1.06	16.34 x 1.81 x 1.06	17 x 2.95 x 1.10	19.76 x 2.95 x 1.10	22.19 x 2.95 x 1.10
Weight (lbs)	1.74	1.92	2.07	2.07	4.13	4.63	5.07

Order ref.	4011794	4011795	4011796	4011797	4041400	4010308	4041401
Price (\$)	\$927	\$981	\$1,091	\$1,194	\$1,265	\$1,400	\$1,525
Optional Operating Temperature and Pressure AP	Factory installed option - please add AP suffix to order reference number (Example: 4010308-AP)						
Price (\$)	ON REQUEST						

Price Group 70

OPTIONAL EQUIPMENT

Pre-Filter 1 or 5 µm	4011323 (5 µm)	4002890 (1 µm)
Price (\$)	\$177	\$234

Price Group 82

Remote Purge Air Switch PAS	Factory installed option - please add PAS suffix to order reference number (Example: 4010308-PAS)
Price (\$)	\$757

Price Group 70

DRYPOINT® MDp	MDp 25	MDp 35	MDp 45	MDp 55	MDp 65	MDp 100	MDp 130
Connection Size (NPT)	¾"	¾"	¾"	¾"	1½"	1½"	1½"
Inlet Flow Rate (scfm)	25.09	33.46	43.29	55.89	67.21	100.77	134.35

Dimensions and Weight

A (inches)	22.57 x 3.94 x 1.34	24.59 x 3.94 x 1.34	27.35 x 3.94 x 1.34	29.98 x 3.94 x 1.34	31.30 x 5.74 x 1.89	36.80 x 5.74 x 1.89	42.75 x 5.74 x 1.89
Weight (lbs)	7.72	9.03	9.04	9.75	20.00	22.44	24.86

Order ref.	4009631	4008460	4010490	4041402	4010800	4011370	4011090
Price (\$)	\$1,813	\$1,988	\$2,180	\$2,466	\$4,533	\$6,008	\$7,682
Optional Operating Temperature and Pressure AP	Factory installed option - please add AP suffix to order reference number (Example: 40xxxxx-AP)						
Price (\$)	ON REQUEST						

Price Group 70

OPTIONAL EQUIPMENT

Pre-Filter 1 µm	4020220	4002891	4002892	4002893	4020305
Price (\$)	\$250	\$278	\$328	\$374	\$409

Price Group 82

Remote Purge Air Switch PAS	Factory installed option - please add PAS suffix to order reference number (Example: 4010800-PAS)
Price (\$)	\$757

Price Group 70

DRYPOINT® FDR Membrane Dryers

pre-configured filter, dryer and pressure regulator packages

- › Pre-configured FDR packages include all required filtration
- › Custom configurations available to suit application
- › Min. ambient air temperature: 34 °F
- › Max. standard operating temperature: 130 °F
- › Max. standard operating pressure: 140 psig
- › Max. optional operating temperature: 160 °F
- › Max. optional operating pressure: 232 psig

Maintenance Interval: 4,000 - 8,000 hours
 Maintenance and Spare Parts: Page 101
 Extended Warranty: Page 144

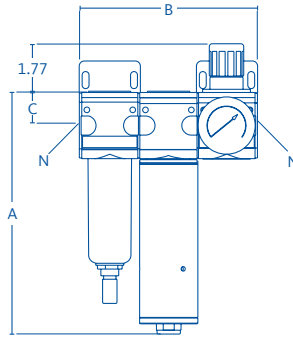

FDR 2 - 8

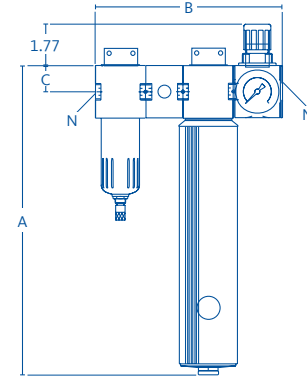

FDR 10 - 17

DRYPOINT® FDR	FDR 2	FDR 4	FDR 6	FDR 8	FDR 10	FDR 12	FDR 17
Connection Size (NPT)	¼"	¼"	¼"	¼"	¼"	¼"	¼"
Inlet Flow Rate (scfm)	2.09	4.18	6.27	8.36	11.34	12.55	16.73

Dimensions and Weight

A x B x C (inches)	7.48 x 5.51 x 1.06	9.44 x 5.51 x 1.06	11.02 x 5.51 x 1.06	13.38 x 5.51 x 1.06	13.38 x 6.88 x 1.06	16.14 x 6.88 x 1.06	18.50 x 6.88 x 1.06
Weight (lbs)	2.97	3.15	3.30	3.50	6.39	6.83	7.27

Order ref.	4032040	4032041	4032042	4032043	4032044	4032045	4032046
Price (\$)	\$1,186	\$1,331	\$1,376	\$1,472	\$1,624	\$1,738	\$1,870
Optional Operating Temperature and Pressure AP	Factory installed option - please add AP suffix to order reference number (Example: 40xxxxx-AP)						
Price (\$)	ON REQUEST						

Price Group 70

DRYPOINT® MDi Product Selector Chart

product sizing table for MDi series membrane air dryers

Inlet Pressure Dew Point (PDP)		Desired Outlet PDP Result Based on Nearest Inlet PDP Parameter			
40 °F	with refrigerant drying	26 °F	0 °F	-30 °F	-40 °F
100 °F	without refrigerant drying	70 °F	35 °F	-4 °F	-20 °F

Model Selector	Flow Rate (scfm)							
	Inlet	Outlet	Inlet	Outlet	Inlet	Outlet	Inlet	Outlet
MDi 12	12.55	11.50	6.20	5.15	4.31	3.26	3.89	2.84
MDi 17	16.73	15.33	8.25	6.85	5.75	4.35	5.14	3.74
MDi 25	25.09	23.00	12.41	10.31	8.63	6.53	7.86	5.76
MDi 35	33.46	30.66	16.53	13.74	11.50	8.70	10.38	7.58
MDi 45	43.01	38.99	23.70	19.68	16.49	12.47	14.52	10.50
MDi 55	52.63	47.90	27.50	22.78	19.38	14.66	16.94	12.22
MDi 65	64.13	58.36	33.11	27.34	23.49	17.72	20.99	15.19
MDi 100	95.84	87.10	50.53	41.79	35.69	26.95	32.09	23.39
MDi 130	128.25	116.72	66.98	55.45	47.40	35.86	43.15	31.65

Flow rate values and performance values are based on having the DRYPOINT® MDi in the constant mode. Outlet pressure dew point settings are user adjustable and will alter the flow rate at the outlet of the membrane dryer based on the adjustment made.

Correction Factors

Operating Pressure (psig)	40	50	60	70	80	90	100	110	120	130	140
Correction Factor	0.22	0.32	0.42	0.54	0.68	0.83	1.00	1.13	1.26	1.40	1.55

The correction factors on this page provide an estimation of the performance that can be achieved with the model sizes shown. For precise sizing for your application, please contact your BEKO Technologies sales representative.

DRYPOINT® MDi ecoIntelligent Series Membrane Dryers

membrane air dryer with adjustable pressure dew point control

ECO CHOICE

- › Integrated pre-filtration: .01 µm
- › Electrical power required: 115-230 VAC / 50-60 Hz
- › Min. ambient air temperature: 34 °F
- › Max. operating temperature: 122 °F
- › Max. operating pressure: 145 psig

Maintenance Interval: 8,000 hours
 Maintenance and Spare Parts: Page 101
 Extended Warranty: Page 144

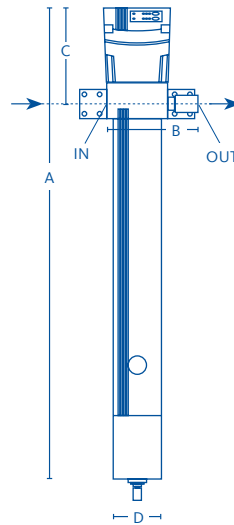

DRYPOINT® MDi	MDi 12	MDi 17	MDi 25	MDi 35	MDi 45	MDi 55	MDi 65	MDi 100	MDi 130
Connection Size (NPT)	3/8"	3/8"	3/4"	3/4"	3/4"	3/4"	1"	1"	1"
Inlet Flow Rate (scfm)	12.55	16.73	25.09	33.46	43.01	52.63	64.13	95.84	128.25

Dimensions and Weight

A (inches)	24.44	26.81	27.20	29.17	31.93	34.69	35.87	41.38	47.28
B (inches)	5.90	5.90	7.06	7.06	7.06	7.06	9.84	9.84	9.84
C (inches)	5.67	5.67	5.90	5.90	5.90	5.9	6.46	6.46	6.46
D (inches)	2.36	2.36	3.14	3.14	3.14	3.14	4.92	4.92	4.92
Weight (lbs)	7.50	7.93	10.80	11.46	12.13	12.79	24.03	26.46	28.88

Order ref.	4040184	4040185	4040186	4040187	4040188	4040189	4040190	4040191	4040192
Price (\$)	\$2,126	\$2,245	\$2,555	\$2,738	\$2,925	\$3,103	\$5,511	\$6,946	\$8,283

Price Group 70

**OPTIONAL
 PRE-FILTRATION**

	S040	S045	S050	S055	S075	S100
Pre-Filter 1 or 5 µm	4002890	4020220	4002891	4002892	4002893	4020305
Price (\$)	\$234	\$250	\$278	\$328	\$374	\$409

Price Group 82

DRYPOINT® MD Accessories

■ for MDe, MDp and FDR series membrane dryers

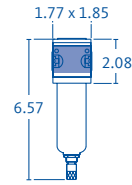

¼" Connection Size (NPT)	with float drain and connection kit 5 µm	with float drain and connection kit .01 µm	with connection kit
	Pre-Filter FD04 (White)	Micro-Filter FD05 (Green)	Activated Carbon Filter FD09
Order ref.	4011323	4005810	4008652
Price (\$)	\$177	\$219	\$173

Price Group 80

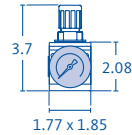

	Pressure Regulator with Differential Pressure Gauge Max. 232 psig	Fine Pressure Regulator with Differential Pressure Gauge Max. 232 psig
Pressure Scale (psig)	44-145 (¼")	4.4-44 (¼")
Order ref.	4005032	4009194
Price (\$)	\$ 188	\$220

Price Group 73

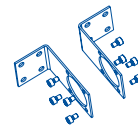

	MDe 2-8 Wall Bracket (optional)	MDp 2-8 Wall Bracket (optional)	MDe / MDp 10-17 Wall Bracket (included in box)	MDe / MDp 25-55 Wall Bracket (included in box)	MDe / MDp 65-130 Wall bracket (included in box)
Order ref.	4006735	4008004	4003328	4003329	4003330
Price (\$)	\$56	\$35	\$71	\$81	\$95

Price Group 73

DRYPOINT® MD Maintenance

- filter elements and float drain for MDp and MDi series

Maintenance Interval: < 8,000 hours

Filter Elements	DM08 PLUS Series and MDp 2-8	DM10 PLUS Series and MDp / MDi 10-17	DM20 PLUS Series man. before May 2009	DM20 PLUS Series man. after May 2009 and MDp / MDi 25-55	DM40 PLUS Series and MDp / MDi 65-130
Order ref.	4007467	4007268	4007268	4010849	4009150
Price (\$)	\$77	\$113	\$113	\$142	\$223

Price Group 83

Float Drain		
Order ref.	4025973	4025537
Price (\$)	\$106	\$106

Price Group 84

DRYPOINT® FDR Maintenance

- filter elements and float drain for FDR series

Maintenance Interval: < 8,000 hours

Filter Elements	FKN00-26X5 5 µm Pre-Filter Element (White)	FKN23-35XA .01 µm Micro-Filter Element (Green)	AC Activated Carbon Filter Element
Order ref.	4011325	4004904	4007041
Price (\$)	\$20	\$112	\$103

Price Group 83

Float Drain	
Order ref.	4025973
Price (\$)	\$106

Price Group 84

DRYPOINT® MDi Spare Parts

- replacement control units

Control Units for Model	MDi 12	MDi 17	MDi 25	MDi 35	MDi 45	MDi 55	MDi 65	MDi 100	MDi 130
Order ref.	4040164	4040166	4040167	4040168	4040169	4040170	4040171	4040172	4040173
Price (\$)	\$992	\$992	\$992	\$992	\$992	\$992	\$992	\$992	\$992

Price Group 73



Condensate Drainage

BEKOMAT®

intelligent condensate drainage with true zero air loss

- › Standard Condensate Drains
- › High Pressure Condensate Drains
- › Condensate Drains for Centrifugal Compressors
- › Condensate Drains for Vacuum Systems
- › Condensate Drains for Explosive Atmospheres

BEKOMAT® Product Selector Chart

Compressor HP	Compressor SCFM	After Cooler	Wet Receiver Tank	Pre-Filter	Refrigerant Dryer	Post-Filter	Dry Receiver Tank
20	100	31	31	31	31	31	31
40	180	32	32	31	31	31	31
50	225	32	32	31	32	31	32
60	270	33	33	31	32	31	32
75	338	33	33	31	32	31	32
100	500	33	33	31	32	31	32
125	563	13	13	31	33	31	33
150	675	13	13	31	33	31	33
175	788	13	13	31	33	31	33
200	900	13	13	31	33	31	33
250	1125	13	13	32	13	32	13
300	1300	13	13	32	13	32	13
400	1800	14	14	32	13	32	13
500	2250	14	14	32	13	32	13
750	3375	14	14	33	14	33	14
1000	5000	14	14	33	14	33	14
1250	5625	16	16	13	14	13	14
1500	6750	16	16	13	14	13	14
1750	7875	16	16	13	14	13	14
2000	9000	16	16	13	14	13	14
2500	11250	16	16	13	16	13	16
3000	13500	16	16	13	16	13	16
4000	18000	16	16	14	16	14	16
5000	22500	16	16	14	16	14	16

To use the BEKOMAT® Product Selector Chart, first locate either your compressor horsepower (for multiple compressors use the total system horsepower) or the net flow rate of your compressed air system. Follow the row to the right and locate the column with the appropriate installation point for your application (i.e wet receiver tank) and you will instantly know the correct BEKOMAT® model size for your application and installation point.

For extremely corrosive applications where excessive amounts of rust, scale or particles are present please contact your BEKO representative for special installation instructions.

Product Code Key

oil and oil-free condensate
all standard models

A

special gas application
CO variants

B

highly corrosive applications
stainless steel variants

C

BEKOMAT® Standard Condensate Drains

for standard pressure

- › Automatic zero loss drain
- › Standard Viton® diaphragm
- › UL/CSA approved
- › Min. / max. operating temperature: 33 °F / 140 °F
- › Standard voltage:
 - BEKOMAT® 31-33: 95-240 VAC 50/60 Hz /100-125 VDC
 - BEKOMAT® 13-16: 115 VAC
- › Optional voltages:
 - BEKOMAT® 31-33: 18 - 72 VDC, 24 - 48 VAC
 - BEKOMAT® 13-16: 24 VAC/DC, 230 VAC 50/60 Hz

Maintenance Interval: < 8,000 hours
 Maintenance and Spare Parts: Page 110
 Extended Warranty: Page 144

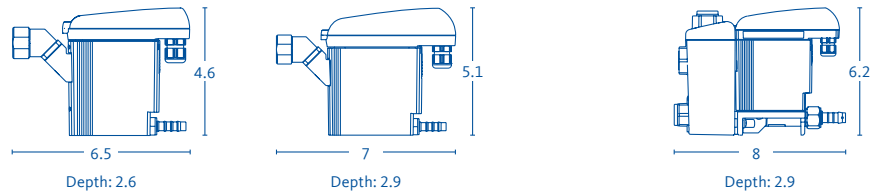

BEKOMAT®	31	32	33	33 CO
Connection (NPT)	1 x 1/2"	1 x 1/2"	3 x 1/2"	3 x 1/2"
Min. / Max. Pressure (psig)	12 / 232	12 / 232	12 / 232	12 / 232
Compressor Flow Rate (scfm)	100	225	500	500
Dryer Flow Rate (scfm)	200	450	1000	1000
Filter Flow Rate (scfm)	1000	2250	5000	5000
Product Key » page 104	A	A	A	A, B

Order ref.	4025038	4025088	4025094	4025096
Price (\$)	\$250	\$339	\$599	\$665

Price Group 12

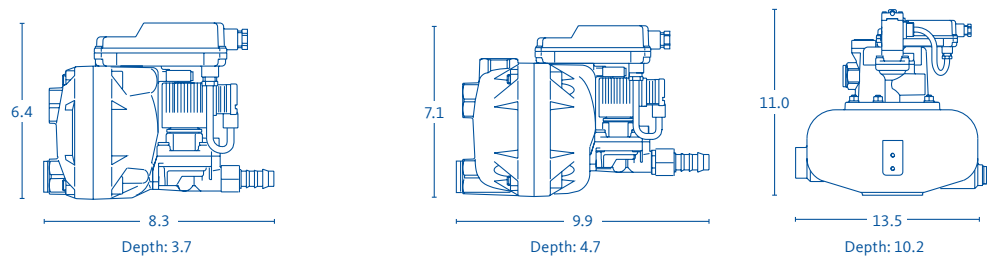

BEKOMAT®	13	13 CO	14	14 CO	16 CO
Connection (NPT)	2 x 1/2"	2 x 1/2"	3 x 3/4"	3 x 3/4"	2 x 3/4" / 1 x 1"
Min. / Max. Pressure (psig)	12 / 232	12 / 232	12 / 232	12 / 232	12 / 232
Compressor Flow Rate (scfm)	1300	1300	5400	5400	50000
Dryer Flow Rate (scfm)	2600	2600	10800	10800	100000
Filter Flow Rate (scfm)	13000	13000	54000	54000	500000
Product Key » page 104	A	A, B	A	A, B	A, B

Order ref.	2002944	2002957	2002968	2002976	2002983
Price (\$)	\$890	\$1,253	\$1,205	\$1,637	\$2,476

Price Group 10

BEKOMAT® PN Condensate Drains

for high pressure systems

- › Automatic zero loss drain
- › Standard Viton® diaphragm
- › Min. / max. operating temperature: 33 °F / 140 °F
- › Standard voltage: 115 VAC
- › Optional voltages:
24 VAC/DC,
230 VAC 50/60 Hz

Maintenance Interval: < 8,000 hours
Maintenance and Spare Parts: Page 110
Extended Warranty: Page 144

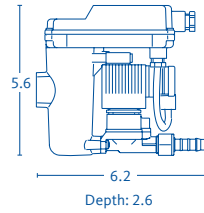

Aluminum housing
+ hard coating & high pressure

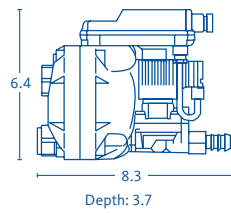

Aluminum housing
+ hard coating & high pressure

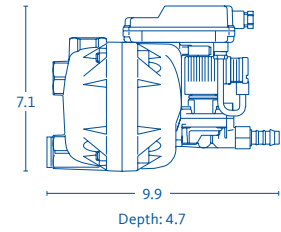

Aluminum housing
+ hard coating & high pressure

BEKOMAT®	12 CO PN 63	13 CO PN 50	14 CO PN 25
Connection (NPT)	1 x ½"	2 x ½"	3 x ¾"
Min. / Max. Pressure (psig)	12 / 912	12 / 725	12 / 360
Compressor Flow Rate (scfm)	280	1300	5400
Dryer Flow Rate (scfm)	560	2600	10800
Filter Flow Rate (scfm)	2800	13000	54000
Product Key » page 104	A, B	A, B	A, B
Order ref.	2002931	4006463	4005485
Price (\$)	\$1,215	\$2,002	\$2,541

Price Group 10

BEKOMAT® E Condensate Drains

for high pressure systems with stainless steel drain body

- › Automatic zero loss drain
- › Standard Viton® diaphragm
- › Min. / max. operating temperature: 33 °F / 140 °F
- › Standard voltage: 115 VAC
- › Optional voltages:
24 VAC/DC,
230 VAC 50/60 Hz

Maintenance Interval: < 8,000 hours
Maintenance and Spare Parts: Page 110
Extended Warranty: Page 144

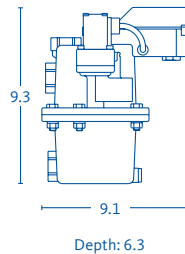

Stainless Steel housing
+ high pressure

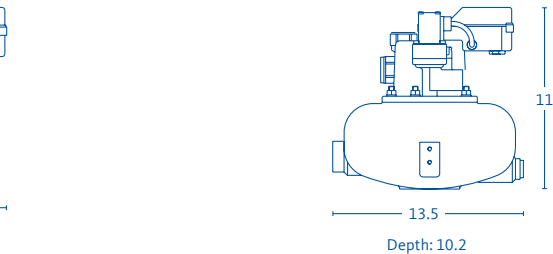

Stainless Steel housing
+ high pressure

Stainless Steel housing
+ high pressure

BEKOMAT®	3 E 25	3 E 63	6 E 25
Connection (NPT)	3 x ¾"	3 x ¾"	2 x ¾" / 1 x 1"
Min. / Max. Pressure (psig)	12 / 360	12 / 912	12 / 360
Compressor Flow Rate (scfm)	4500	4500	50000
Dryer Flow Rate (scfm)	9000	9000	100000
Filter Flow Rate (scfm)	45000	45000	500000
Product Key » page 104	A, B, C	A, B, C	A, B, C
Order ref.	4020176	2002876	2002890
Price (\$)	\$5,126	\$5,565	\$8,865

Price Group 11

BEKOMAT® CV Condensate Drains

for centrifugal compressors with check valve

- › Automatic zero loss drain
- › Standard Viton® diaphragm
- › Min. / max. operating temperature: 33 °F / 140 °F
- › Standard voltage: 115 VAC
- › Optional voltages:
24 VAC/DC,
230 VAC 50/60 Hz

Maintenance Interval: < 8,000 hours
Maintenance and Spare Parts: Page 110
Extended Warranty: Page 144

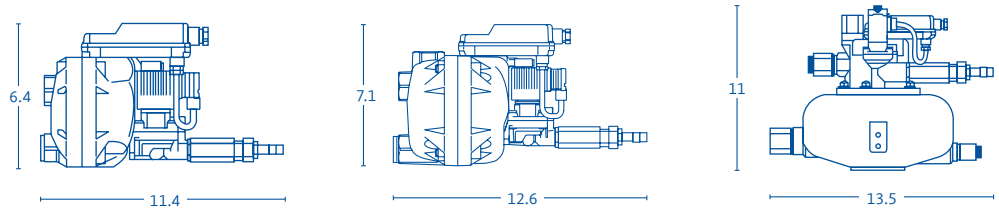

Aluminum housing
+ check-valve set

Aluminum housing
+ check-valve set

Aluminum housing
+ check-valve set & hard coating

BEKOMAT®	13 CV	14 CV	16 CO CV
Connection (NPT)	2 x ½"	3 x ¾"	2 x ¾" / 1 x 1"
Min. / Max. Pressure (psig)	12 / 232	12 / 232	12 / 232
Compressor Flow Rate (scfm)	2000	8000	50000
Dryer Flow Rate (scfm)	4000	16000	100000
Filter Flow Rate (scfm)	20000	80000	500000
Product Key » page 104	A	A	A, B
Order ref.	4015770	4006574	4016313
Price (\$)	\$1,077	\$1,428	\$2,636

Price Group 10

BEKOMAT® NLV Condensate Drains

for centrifugal compressors with no-load valve

- › Automatic zero loss drain
- › Standard Viton® diaphragm
- › Min. / max. operating temperature: 33 °F / 140 °F
- › Standard voltage: 115 VAC
- › Optional voltages:
24 VAC/DC,
230 VAC 50/60 Hz

Maintenance Interval: < 8,000 hours
Maintenance and Spare Parts: Page 110
Extended Warranty: Page 144

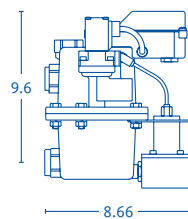

Depth: 6.30

Aluminum housing
+ no load valve & hard coating

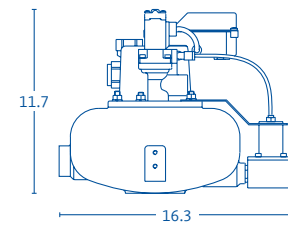

Depth: 10.2

Aluminum housing
+ no load valve & hard coating

BEKOMAT®	3 CO NLV	6 CO NLV
Connection (NPT)	3 x ¾"	2 x ¾" / 1 x 1"
Min. / Max. Pressure (psig)	0 / 360	0 / 232
Compressor Flow Rate (scfm)	6000	50000
Dryer Flow Rate (scfm)	12000	100000
Filter Flow Rate (scfm)	60000	500000
Product Key » page 104	A, B	A, B
Order ref.	2002883	2002894
Price (\$)	\$2,653	\$3,515

Price Group 10

BEKOMAT® V Condensate Drains

for low pressure and vacuum systems with patented technology

- › Automatic zero loss drain
- › Standard Viton® diaphragm
- › Min. / max. operating temperature: 33 °F / 140 °F
- › Standard voltage: 115 VAC
- › Optional voltages:
24 VAC/DC,
230 VAC 50/60 Hz

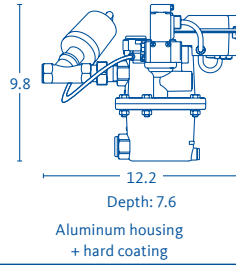

Maintenance Interval: < 8,000 hours
Maintenance and Spare Parts: Page 110
Extended Warranty: Page 144

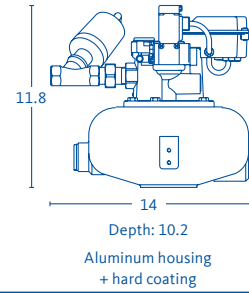

BEKOMAT®	3 CO V	6 CO V
Connection (NPT)	1 x ¾"	1 x ¾"
Min. / Max. Pressure (psia)	1.45 / 26	1.45 / 26
Compressor Flow Rate (scfm)	4500	50000
Dryer Flow Rate (scfm)	9000	100000
Filter Flow Rate (scfm)	45000	500000
Product Key » page 104	A, B	A, B
Order ref.	2002888	4001724
Price (\$)	\$2,785	\$3,663

Price Group 10

BEKOMAT® EX Condensate Drains

for explosive atmospheres

- › Automatic zero loss drain
- › Standard Viton® diaphragm
- › Min. / max. operating temperature: 33 °F / 140 °F
- › Standard voltage: 12 VDC

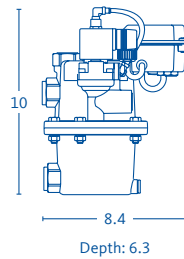

Maintenance Interval: < 8,000 hours
Maintenance and Spare Parts: Page 110
Extended Warranty: Page 144

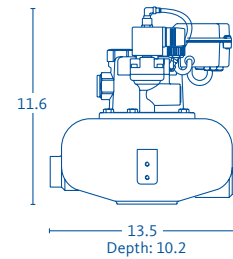

BEKOMAT®	3 CO EX	3 E EX	6 CO EX	6 E EX
	Aluminum housing + hard coating	Stainless Steel housing	Aluminum housing + hard coating	Stainless Steel housing
Connection (NPT)	3 x ¾"	3 x ¾"	2 x ¾" / 1 x 1"	2 x ¾" / 1 x 1"
Min. / Max. Pressure (psig)	12 / 232	12 / 232	12 / 232	12 / 232
Compressor Flow Rate (scfm)	4500	4500	50000	50000
Dryer Flow Rate (scfm)	9000	9000	100000	100000
Filter Flow Rate (scfm)	45000	45000	500000	500000
Product Key » page 104	A, B	A, B, C	A, B	A, B, C
Order ref.	4010556	4007950	2002892	4007027
Price (\$)	\$2,785	\$6,441	\$3,562	\$8,848

Price Group 11

Options	Power Supply 12 VDC recommended intrinsic safety	Isolation Amplifier recommended for connection of BEKOMAT® EX with potential free control
Voltage	110-230 VAC	230 VAC
Order Number	4005140	4006591
Price (\$)	\$2,364	\$1,148

Price Group 14

BEKOMAT® Large Capacity Condensate Drains

for large capacity compressors

- › Automatic zero loss drain
- › Standard Viton® diaphragm
- › Min. / max. operating temperature: 33 °F / 140 °F
- › Standard voltage: 110 VAC

Maintenance Interval: < 8,000 hours
 Maintenance and Spare Parts: Page 110
 Extended Warranty: Page 144

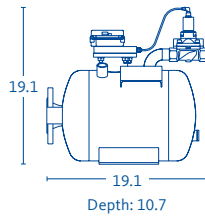

Stainless steel housing + potential contact

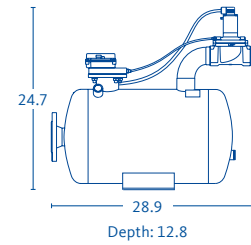

Stainless steel housing + potential contact

BEKOMAT®	8	9
Connection (Flanged)	2"	2"
Min. / Max. Pressure (psig)	7.5 / 143	7.5 / 60
Compressor Flow Rate (scfm)	330500 to 500000	850000 to 1050000
Product Key » page 104	A, B, C	A, B, C

Order ref.	4052971	4052972
Price (\$)	\$27,195	\$31,126

Price Group 11

BEKOMAT® Accessories

- heating units

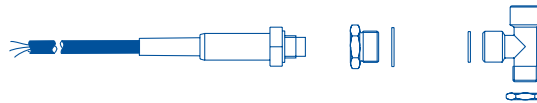

Operating Voltage	Max. Performance	BEKOMAT® 1x Drains Min. Temperature*	BEKOMAT® 33 Min. Temperature*	Max. Pressure	Pipe Connection
115 VAC	137 W	-10 °F	5 °F	360 psig	NPT or BSP
230 VAC	125 W	-10 °F	5 °F	360 psig	NPT or BSP
24 VAC/VDC	50 W	25 °F	25 °F	360 psig	NPT or BSP

	115 VAC / NPT	115 VAC / BSP	230 VAC / NPT	230 VAC / BSP	24 VAC / VDC / NPT	24 VAC / VDC / BSP
Order ref.	2801246	2801245	2002447	2801244	2002448	2801247
Price (\$)	\$457	\$457	\$457	\$457	\$457	\$457

Price Group 13

*Minimum temperatures shown are only applicable when used in combination with proper insulation. This applies to all model sizes. Insulation shells are available for BEKOMAT® 12, 13 and 14 below. BEKOMAT® 3x series drains and BEKOMAT® 16 models must be insulated on-site according to the application.

Caution! heating units are not to be used with: BEKOMAT® 10, 20 or 21. This also includes high pressure BEKOMAT® models and applications in areas with potentially explosive atmospheres.

- insulation shells

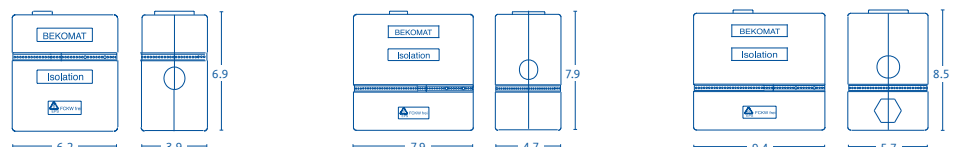

	12 12 CO 12 COPN 63	13 13 CO 13 COPN 25/40/50	14 14 CO 14 COPN 25
Order ref.	2000195	2000033	2000034
Price (\$)	\$57	\$62	\$68

Price Group 13 109

BEKOMAT® Accessories

■ ½" connection kit

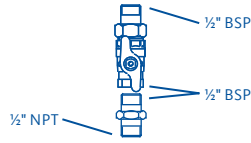

Operating Conditions	½" connection kit with ball valve for S040-M032 L100-L304
Max. Pressure (psig)	232
Order ref.	2002228
Price (\$)	\$68

Price Group 84

BEKOMAT® Maintenance

■ annual service kits / wearing parts kits for current generation drains

Maintenance Interval: < 8,000 hours

Drain Model	Order ref.	Price (\$)
BEKOMAT® 31	4023608	\$141
BEKOMAT® 32	4025061	\$167
BEKOMAT® 33	4023634	\$219
BEKOMAT® 33 CO	4023636	\$263

Price Group 12

BEKOMAT® 12	4012942	\$154
BEKOMAT® 12 CO		
BEKOMAT® 12 CO PN 63	2000748	\$162
BEKOMAT® 13	4011612	\$154
BEKOMAT® 13 CO		
BEKOMAT® 13 CO PN 25	2000366	\$162
BEKOMAT® 13 CO PN 40 / 45 / 50		
BEKOMAT® 14	2002300	\$157
BEKOMAT® 14 CO		
BEKOMAT® 14 CO PN 25	2002556	\$165
BEKOMAT® 16 CO	4028261	\$197

Price Group 13

■ annual wearing parts kits for previous generation drains

Maintenance Interval: < 8,000 hours

Drain Model	Order ref.	Price (\$)
BEKOMAT® 10 / 10 F (serial no. 283.450 & newer)	2000451	\$104
BEKOMAT® 11 (serial no. 155.000 & newer)	2800842	\$178
BEKOMAT® 11 CO (serial no. 155.00 & newer)		
BEKOMAT® 20	4003701	\$113
BEKOMAT® 20 FM		
BEKOMAT® 21	2001365	\$102
BEKOMAT® 21 PRO		
BEKOMAT® 3	2800656	\$165
BEKOMAT® 3 CO / CO LA	2800670	\$179
BEKOMAT® 3 E	2800702	\$226
BEKOMAT® 3 E 25		
BEKOMAT® 3 E 63		
BEKOMAT® 6 CO / CO LA	2800656	\$165
BEKOMAT® 6 E 25	2800702	\$226

Price Group 13

BEKOMAT® Spare Parts

■ for current generation drains

	31	32	33	33 CO
Barbed Hose Connector 10 pcs.	2002310	2002310	2001457	2001457
Price (\$)	\$48	\$48	\$60	\$60
Sealing Kit	4024386	4024392	4024397	4024397
Price (\$)	\$34	\$34	\$37	\$37

Price Group 13

	12	12 CO	12 CO PN 63
Barbed Hose Connector 10 pcs.		2002312	
Price (\$)		\$54	
Set of Diaphragms 3 pcs		2000437	
Price (\$)		\$210	
Valve Complete	4027846	4027847	4027848
Price (\$)	\$198	\$235	\$940
Valve Attachment Components	2000052	2000053	2000054
Price (\$)	\$60	\$67	\$698
Sealing Kit		2000058	2000749
Price (\$)		\$42	\$44

Price Group 13

	12 CO Ni	12 KW
Sealing Kit		2000058
Price (\$)		\$42

Price Group 13

	13	13 CO	13 CO PN 25	13 CO PN 40 45 50
Barbed Hose Connector 10 pcs.		2001457		-
Price (\$)		\$60		-
Set of Diaphragms 3 pcs		2000439		
Price (\$)		\$287		
Diaphragm Seat		2001118		2000351
Price (\$)		\$73		\$303
Valve Complete	4027849	4027850		4027851
Price (\$)	\$243	\$280		\$1,076
Valve Attachment Components	2000071	2000072		2000371
Price (\$)	\$92	\$94		\$891
Sealing Kit		2000073		2000367
Price (\$)		\$44		\$50
Housing (inlet side)	2000077	2000078		2000369
Price (\$)	\$173	\$575		\$667

Price Group 13

	14	14 CO	14 CO PN 25	16 CO
Barbed Hose Connector 10 pcs.		2001457	-	-
Price (\$)		\$60	-	-
Set of Diaphragms 3 pcs		2000439		
Price (\$)		\$287		
Diaphragm Seat		2001118	2000351	-
Price (\$)		\$73	\$303	-
Valve Complete	4027849	4027850	4027851	2000089
Price (\$)	\$243	\$280	\$1,076	\$332
Valve Attachment Components	2000071	2000072	2000371	2000088
Price (\$)	\$92	\$94	\$891	\$74
Sealing Kit	2000080		4000923	2000090
Price (\$)	\$42		\$50	\$44
Housing (inlet side)	2000084		2000085	2000091
Price (\$)	\$280		\$624	\$758

Price Group 13

BEKOMAT® Spare Parts

■ for current generation drains

	12	12 CO	12 CO PN 63	12 KW
Top Electrical Unit		4010940		
Price (\$)		\$153		
Sensor Control Board		4047971		4047977
Price (\$)		\$408		\$373
Power Supply Board 230 VAC		2000063		
Price (\$)		\$198		
Power Supply Board 200 VAC		2000349		
Price (\$)		\$198		
Power Supply Board 115 VAC		2000064		
Price (\$)		\$198		
Power Supply Board 100 VAC		2000611		
Price (\$)		\$198		
Power Supply Board 24 VAC		2000065		
Price (\$)		\$198		
Power Supply Board 24 VDC		2000756		
Price (\$)		\$198		

Price Group 13

	13	13 CO	13 CO PN 25	13 CO PN 40 45 50
Top Electrical Unit		4010940		
Price (\$)		\$153		
Sensor Control Board		2000079		
Price (\$)		\$408		
Power Supply Board 230 VAC		2000063		
Price (\$)		\$198		
Power Supply Board 200 VAC		2000349		
Price (\$)		\$198		
Power Supply Board 115 VAC		2000064		
Price (\$)		\$198		
Power Supply Board 100 VAC		2000611		
Price (\$)		\$198		
Power Supply Board 24 VAC		2000065		
Price (\$)		\$198		
Power Supply Board 24 VDC		2000756		
Price (\$)		\$198		

Price Group 13

	14	14 CO	14 CO PN 25	16 CO
Top Electrical Unit		4010940		
Price (\$)		\$153		
Sensor Control Board		2000086		2000093
Price (\$)		\$428		\$428
Power Supply Board 230 VAC		2000063		
Price (\$)		\$198		
Power Supply Board 200 VAC		2000349		
Price (\$)		\$198		
Power Supply Board 115 VAC		2000064		
Price (\$)		\$198		
Power Supply Board 100 VAC		2000611		
Price (\$)		\$198		
Power Supply Board 24 VAC		2000065		
Price (\$)		\$198		
Power Supply Board 24 VDC		2000756		
Price (\$)		\$198		

Price Group 13

BEKOMAT® Spare Parts

■ for previous generation and specialty drains

	20	20 FM	21	21 PRO
Set of Diaphragms 5 pcs.	2000496			
Price (\$)	\$143			
Diaphragm Seat	4003700			2001367
Price (\$)	\$84			\$71
Sealing Kit	-			2001366
Price (\$)	-			\$50
Top Electrical Cover	4004301		2001913	2001914
Price (\$)	\$84		\$120	\$120

Price Group 13

	3	3 CO CO LA	3 E	3 E 25	3 E 63
Set of Diaphragms 3 pcs.	2000439				
Price (\$)	\$287				
Sealing Kit	2800658	2800671	2800689		2800703
Price (\$)	\$42	\$41	\$95		\$95
Top Electrical Cover	2800661			2800690	
Price (\$)	\$171			\$171	
Valve Complete	2800708	2800717	2800692		2800717
Price (\$)	\$158	\$198	\$185		\$198
Control Air Cover	2800665	-	-	-	-
Price (\$)	\$58	-	-	-	-

Price Group 13

	6 CO CO LA	6 E 25
Set of Diaphragms 3 pcs.	2000439	
Price (\$)	\$287	
Sealing Kit	2800658	2800703
Price (\$)	\$42	\$95
Top Electrical Cover	2800661	2800690
Price (\$)	\$171	\$171
Valve Complete	2800663	2800717
Price (\$)	\$163	\$198
Control Air Cover	2800665	-
Price (\$)	\$58	-

Price Group 13

	20	20 FM	21	21 PRO
Sensor Control Board	-	4003705	-	2001494
Price (\$)	-	\$334	-	\$263
Power Supply Board 230 VAC	2001488	2001495	2001488	2001495
Price (\$)	\$246	\$149	\$246	\$149
Power Supply Board 200 VAC	4004090	4001277	4004090	4001277
Price (\$)	\$246	\$149	\$246	\$149
Power Supply Board 100 VAC	4001273	4001275	4001273	4001275
Price (\$)	\$246	\$149	\$246	\$149
Power Supply Board 115 VAC	2001489	2001496	2001489	2001496
Price (\$)	\$246	\$149	\$246	\$149
Power Supply Board 24 VAC	2001490	2001497	2001490	2001497
Price (\$)	\$246	\$149	\$246	\$149
Power Supply Board 24 VDC	-	2001498	-	2001498
Price (\$)	-	\$149	-	\$149

Price Group 13

BEKOMAT® Spare Parts

■ for previous generation and specialty drains

	3	3 CO CO LA	3 E	3 E 25	3 E 63
Valve	2800701	2800673	2800693	2800705	2800718
Price (\$)	\$293	\$631	\$841	\$865	\$868
Power Supply Board 230 VAC			2800659		
Price (\$)			\$585		
Power Supply Board 100 VAC			2002200		
Price (\$)			\$660		
Power Supply Board 115 VAC			2800698		
Price (\$)			\$660		
Power Supply Board 24 VAC			2800699		
Price (\$)			\$660		

Price Group 13

	6 CO CO LA	6 E 25
Valve	2800664	2800705
Price (\$)	\$304	\$865
Power Supply Board 230 VAC		2800796
Price (\$)		\$563
Power Supply Board 115 VAC		2800804
Price (\$)		\$642
Power Supply Board 24 VAC		4010781
Price (\$)		\$658
Power Supply Board 24 VDC		2800806
Price (\$)		\$524

Price Group 13



Condensate Processing

QWIK-PURE® / ÖWAMAT®

highly efficient and economic condensate separation

- › High Efficiency Oil-Water Separators
- › Gravity Oil-Water Separators

QWIK-PURE® Product Selector Chart

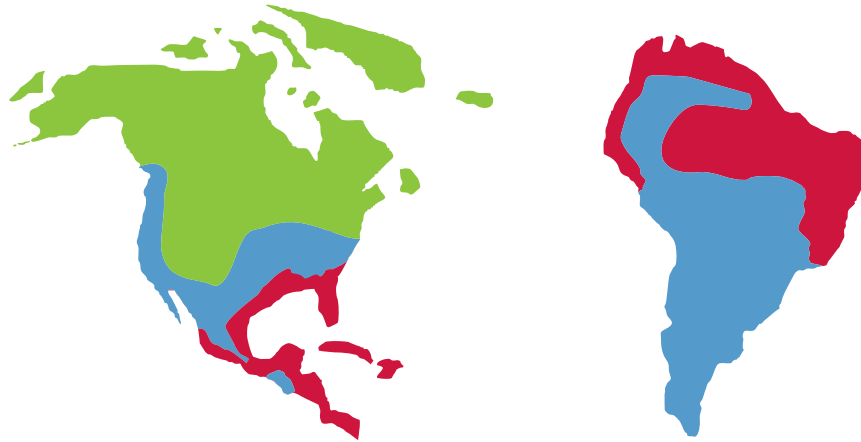

FILTER CARTRIDGE LIFE CYCLE*	
1 Shift Operation	10-14 months
2 Shift Operation	8-12 months
3 Shift Operation	5-9 months

CLIMATE ZONE	YEARLY AVERAGE	CORRECTION FACTOR
Cool / Mild ■	66% RH 45°F	1.00
Medium / Arid ■	67% RH 55°F	.90
Hot / Tropical ■	72% RH 75°F	.80

*Ranges are approximate

Compressor HP	Compressor SCFM	PISTON COMPRESSOR		ROTARY SCREW COMPRESSOR		
		Mineral Oils	Synthetic Oils	Mineral Oils	PAO / Diester Oils	Polyglycol Oils
10	45	25	25	25	25	25
15	60	25	25	25	25	25
20	90	25	50	25	25	50
25	113	50	50	25	50	50
35	158	50	100	50	50	100
40	180	50	100	50	100	100
50	225	100	100	50	100	100
60	270	100	200	100	100	200
75	338	100	200	100	100	200
100	450	200	200	100	200	200
110	495	200	350	200	200	350
130	585	200	350	200	200	350
175	788	350	-	200	350	350
200	900	350	-	200	350	2 x 200
210	945	350	-	350	350	2 x 350
250	1125	350	-	350	2 x 200	2 x 350
270	1215	-	-	350	2 x 200	2 x 350
350	1575	-	-	350	2 x 350	2 x 350
400	1800	-	-	2 x 200	2 x 350	3 x 350
500	2250	-	-	2 x 350	2 x 350	3 x 350
600	2700	-	-	2 x 350	3 x 350	4 x 350
700	3150	-	-	2 x 350	3 x 350	4 x 350
800	3600	-	-	3 x 350	4 x 350	4 x 350
1000	4500	-	-	3 x 350	4 x 350	-
1300	5850	-	-	4 x 350	4 x 350	-
1600	7200	-	-	4 x 350	-	-

IMPORTANT:

The application, your regional location, climate zone, oil type and oil additives, compressor type, condensate volume changes throughout the day and the seasons, tendency of emulsification, and many other specifics may have a significant impact on the sizing of an oil water separator, and the lifetime of the oil water separator cartridge. The sizing correction factors and lifetime of the cartridge are approximate values only.

Please consult your BEKO Technologies representative or your BEKO Technologies certified distributor for details and sizing assistance.

The correction factors on this page provide an estimation of the performance that can be achieved with the model sizes shown.

For precise sizing for your application, please contact your BEKO Technologies sales representative.

QWIK-PURE® High-Efficiency Oil-Water Separators

with direct to cartridge filtration

ECO CHOICE

- › Advanced filling material that increases performance
- › Works well with all lubricant types
- › Lightweight easy to change cartridge
- › Min. / max. ambient temperature: 41 °F / 140 °F
- › Max. condensate temperature: 140 °F
- › Max. operating pressure: 232 psig

Maintenance Interval: 4,000 - 8,000 hours

Maintenance and Spare Parts: Page 121

Extended Warranty: Page 144

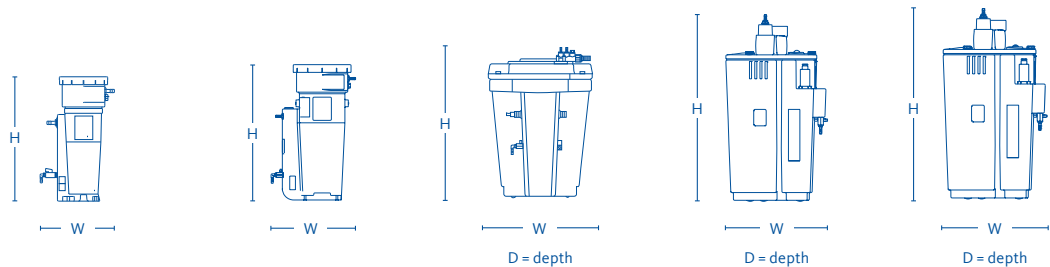

QWIK-PURE®	25	50	100	200	350
Condensate Feed	2 x ½"	2 x ½"	3 x ½" 1 x 1"	3 x ½" 1 x 1"	3 x ½" 1 x 1"
Cartridge Capacity (gal)	1 x 1.3	1 x 2.4	1 x 5.2	1 x 4.9 1 x 5.3	1 x 9.8 1 x 10.7
Tank Capacity (gal)	2.6	4.9	17.7	30.51	60.34
Filling Capacity (gal)	1.1	3.1	12.4	19.15	36.24

Dimensions and Weight

H x W x D (inches)	21 x 8	23 x 15	26 x 18 x 21	44 x 23 x 21	47 x 28 x 26
Weight (lbs)	7.7	12.7	24.5	70.6	92.6

Order ref.	4011732	4012057	4043975	4022393	4022405
Price (\$)	\$466	\$840	\$1,157	\$2,415	\$3,269

Price Group 20

QWIK-PURE® Spill Protection Basin

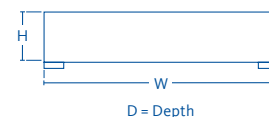
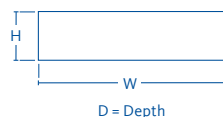

Fits QWIK-PURE® Model	25 50 100	200	350
Dimensions H x W x D (inches)	7 x 24 x 20	9 x 35 x 32	10 x 43 x 35

Order ref.	4047641	4047643	4047644
Price (\$)	\$389	\$573	\$661

Price Group 23

ÖWAMAT® Product Selector Chart

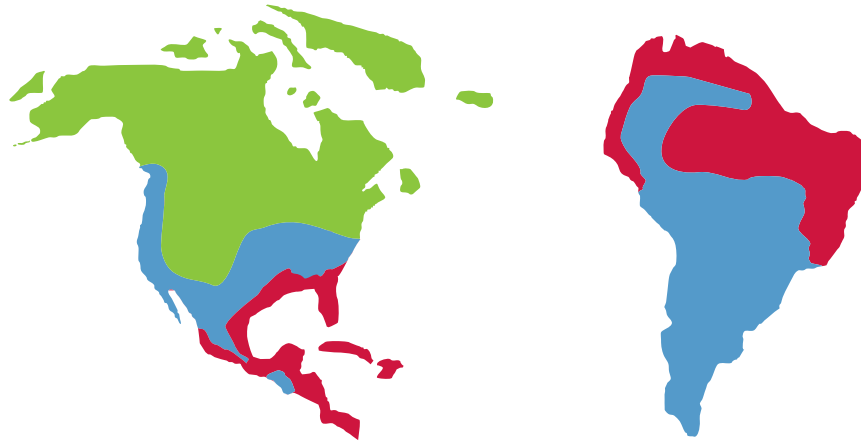

FILTER CARTRIDGE LIFE CYCLE*	
1 Shift Operation	10-14 months
2 Shift Operation	8-12 months
3 Shift Operation	5-9 months

CLIMATE ZONE	YEARLY AVERAGE	CORRECTION FACTOR
Cool / Mild ■	66% RH 45°F	1.00
Medium / Arid ■	67% RH 55°F	.90
Hot / Tropical ■	72% RH 75°F	.80

*Ranges are approximate

Gravity oil-water separators are for condensate mixtures only!

Compressor HP	Compressor SCFM	PISTON COMPRESSOR		ROTARY SCREW COMPRESSOR	
		Mineral Oils	Mineral Oils	PAO / Diester Oils	PAO / Diester Oils
15	60	12	12	12	12
20	90	12	12	12	12
25	113	12	12	12	12
35	158	12	12	12	12
40	180	12	12	12	12
50	225	14	12	14	14
60	270	14	14	14	14
75	338	14	14	14	14
100	450	14	14	15	15
110	495	15	14	15	15
130	585	15	15	15	15
175	788	15	15	16	16
200	900	16	15	16	16
210	945	16	15	16	16
250	1125	16	16	16	16
280	1260	16	16	16	16
350	1575	16	16	2 x 16	2 x 16
400	1800	-	16	2 x 16	2 x 16
450	2050	-	16	2 x 16	2 x 16
600	2700	-	2 x 16	2 x 16	2 x 16
700	3150	-	2 x 16	3 x 16	3 x 16
900	4050	-	2 x 16	4 x 16	4 x 16
1000	4500	-	3 x 16	4 x 16	4 x 16
1350	6075	-	3 x 16	-	-
1400	6300	-	3 x 16	-	-
1850	8400	-	4 x 16	-	-

IMPORTANT:

If you do not know the condensate type (emulsion or mixture) of your application then please always use a QWIK-PURE®.

To use the ÖWAMAT Product Selector Chart, first locate either your compressor horsepower (for multiple compressors use the total system horsepower) or the net flow rate of your compressed air system. Follow the row to the right and locate the column with the appropriate type and lubricant for your particular application (i.e piston compressor with synthetic lubricant) and you will instantly know the correct ÖWAMAT model size for your compressor type.

If you feel that the condensate emulsion for your given application, your regional location, total application volume or any other specific needs may have a significant impact on the application or installation, please consult your BEKO Technologies representative for details and sizing assistance.

The correction factors on this page provide an estimation of the performance that can be achieved with the model sizes shown.

For precise sizing for your application, please contact your BEKO Technologies sales representative.

ÖWAMAT® Gravity Oil-Water Separators

with gravity pre-separation and cartridge filtration

- › Advanced filling material that increases performance
- › Works with condensate mixtures only
- › Lightweight easy to change cartridge
- › Min. / max. ambient temperature: 41 °F / 140 °F
- › Max. condensate temperature: 140 °F
- › Max. operating pressure: 232 psig

Maintenance Interval: 4,000 - 8,000 hours

Maintenance and Spare Parts: Page 121

Extended Warranty: Page 144

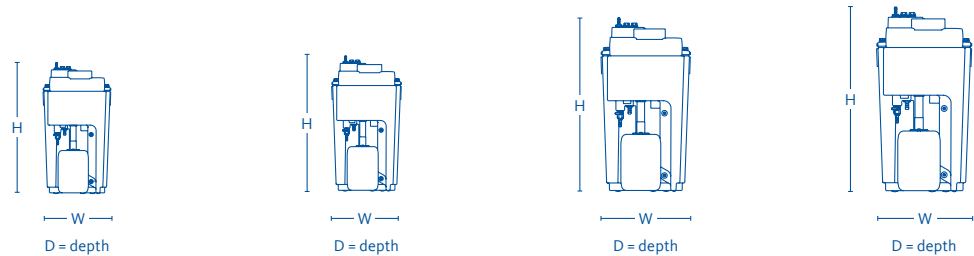

ÖWAMAT®	12	14	15	16
Condensate Feed	3 x ½" 1 x 1"	3 x ½" 1 x 1"	3 x ½" 1 x 1"	3 x ½" 1 x 1"
Cartridge Capacity (gal)	1 x 0.7 1 x 1.4	1 x 1.8 1 x 2.8	1 x 4.9 1 x 5.3	1 x 4.9 1 x 5.3
Tank Capacity (gal)	8.08	16.19	30.51	60.4
Filling Capacity (gal)	6.00	12.23	22.27	41.9
Dimensions and Weight				
H x W x D (inches)	27 x 22 x 14	34 x 25 x 16	43 x 30 x 21	46 x 39 x 26
Weight (lbs)	29.8	40.8	80.5	116.9
Order ref.	4022481	4022482	4022483	4022484
Price (\$)	\$1,771	\$2,301	\$2,945	\$3,969

Price Group 20

ÖWAMAT® Spill Protection Basin

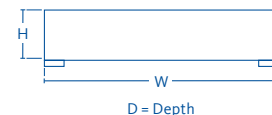



Fits ÖWAMAT® Model	12	14	15	16
Dimensions H x W x D (inches)	7 x 24 x 20	9 x 28 x 24	9 x 35 x 32	10 x 43 x 35
Order ref.	4047641	4047642	4047643	4047644
Price (\$)	\$389	\$508	\$573	\$661

Price Group 23

QWIK-PURE® and ÖWAMAT® Accessories

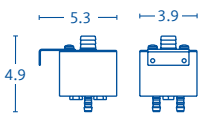
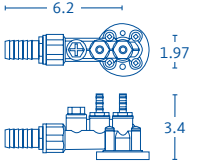
■ for all models

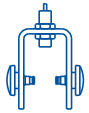
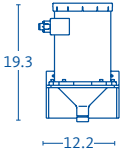
		Order ref.	Price (\$)
Flow Splitter Kit for the Parallel Operation of up to Any Four (4) Units		4003998	\$316
Multiple-Inlet Adapter wall mounted, standalone adapter for multiple condensate feed connections into a single unit		4003993	\$137
Oil Collector Set ÖWAMAT® 12 and 14		2801295	\$105
Oil Collector Set ÖWAMAT® 15		4012569	\$105
Oil Collector Set ÖWAMAT® 16		2801302	\$120
Alarm Sensor for Level Indicator QWIK-PURE® 50 and ÖWAMAT® 11		4012448	\$228
Alarm Sensor for Level Indicator QWIK-PURE® 200 and 350, ÖWAMAT® 12-16		4013908	\$252
High Pressure Relief Chamber for up to 580 psig pressure relief chamber is wall mountable and for use with all models		2801292	\$666

Price Group 23

■ heating units



	QWIK-PURE® 200, ÖWAMAT® 14 and 15 (1000 watt)	QWIK-PURE® 350 and ÖWAMAT® 16 (1400 watt)
Voltage (VAC)	115	115
Weight (lb)	2.2	2.5
Order ref.	4001749	4001751
Price (\$)	\$1,051	\$1,240

Price Group 23

QWIK-PURE® and ÖWAMAT® Maintenance

■ replacement cartridge sets

Maintenance Interval: 4,000 - 8,000 hours

QWIK-PURE® Model	25	50	100	200	350
Pre-Filter (gal)	integrated	integrated	integrated	1x4.9	1x9.6
Cartridge Capacity (gal)	1x1.3	1x2.5	1x5.2	1x5.3	1x10.7
Weight (lbs)	1.1	4.4	11.8	13.3	24.5
Order ref.	4010719	4011999	4044056	4010713	4010714
Price (\$)	\$160	\$267	\$658	\$723	\$939

Price Group 22

ÖWAMAT® Model	12	14	15	16
Pre-Filter (gal)	1x0.7	1x1.8	1x4.9	1x9.6
Cartridge Capacity (gal)	1x1.4	1x2.8	1x5.3	1x10.7
Weight (lbs)	4.4	7.4	13.3	24.5
Order ref.	4010711	4010712	4010713	4010714
Price (\$)	\$250	\$396	\$723	\$939

Price Group 22

■ replacement filter bag sets for previous generations

Maintenance Interval: 4,000 - 8,000 hours

ÖWAMAT® Model	1 2 and QWIK-PURE® 20	3	4	5	5R	6	8
Filter Set	4027544	4027548	4027550	4027554	4027556	4027557	4027562
Price (\$)	\$160	\$251	\$294	\$542	\$439	\$585	\$1,472

Price Group 22

QWIK-PURE® Spare Parts

■ for current generation models

	QWIK-PURE® 25	QWIK-PURE® 50	QWIK-PURE® 100	QWIK-PURE® 200	QWIK-PURE® 350
Pressure Relief Chamber	-	-	-	4012142	
Price (\$)	-	-	-	\$288	
Pop-up Indicator	-	4011575	-	4022541	4022540
Price (\$)	-	\$29	-	\$35	\$36
Multiple Inlet Adapter	-	-	4020311		
Price (\$)	-	-	\$66		
Cover Lid	4004290	-	4003753	4012349	4012350
Price (\$)	\$60	-	\$165	\$262	\$319
Container	4012557	4012559	4003741	4012505	4012506
Price (\$)	\$288	\$479	\$325	\$1,369	\$1,663
Handle for Cartridge	-	-	-	4012358	4012359
Price (\$)	-	-	-	\$92	\$99
Universal Sampling Valve Set	4012379		-	4012379	
Price (\$)	\$36		-	\$36	
Mounting Bracket	4004277	4012186	-	-	-
Price (\$)	\$97	\$106	-	-	-
Plastic Sample Vial 20 mg/l	2000556				
Price (\$)	\$25				
Plastic Sample Vial 10 mg/l	4001475				
Price (\$)	\$25				
Lid Screws (set of 3)	-	-	4023627		
Price (\$)	-	-	\$18		

Price Group 23

ÖWAMAT® Spare Parts

■ for current generation models

	ÖWAMAT® 12	ÖWAMAT® 14	ÖWAMAT® 15	ÖWAMAT® 16
Pressure Relief Chamber	4012139	4012139	4012141	4012141
Price (\$)	\$211	\$211	\$288	\$288
Multiple Inlet Adapter	2002851	2002851	4020311	
Price (\$)	\$60	\$60	\$66	
Pre-Separation Tank serial no. 12438530 & newer	4021012	4021013	4021014	4021015
Price (\$)	\$174	\$211	\$271	\$329
Pre-Separation Tank	4012135	4012136	4012137	4012138
Price (\$)	\$174	\$211	\$271	\$329
Pre-Separation Tank Stand	4012162	4012163	4012164	4012165
Price (\$)	\$110	\$121	\$132	\$149
Cover Lid	4012342	4012343	4012349	4012350
Price (\$)	\$174	\$211	\$262	\$319
Container	4012503	4012504	4012505	4012506
Price (\$)	\$775	\$1,072	\$1,369	\$1,663
Overflow Pipe serial no. 12438530 & newer	4021003		4021005	4021006
Price (\$)	\$74		\$147	\$157
Overflow Pipe	4012564	4012565	4012566	4012567
Price (\$)	\$74	\$97	\$147	\$157
Handle for Cartridge	4012356	4012357	4012358	4012359
Price (\$)	\$71	\$83	\$92	\$99
Universal Sampling Valve Set	4012379			
Price (\$)	\$36			
Plastic Sample Vial 20 mg/l	2000556			
Price (\$)	\$25			
Plastic Sample Vial 10 mg/l	4001475			
Price (\$)	\$25			
Screw Plug Set G1	-	4020988		
Price (\$)	-	\$70		
Sealing Part Set V03 serial no. 12438530 & newer	4022580		4022581	
Price (\$)	\$55		\$92	
Lid Screws (set of 3)	4023627			
Price (\$)	\$18			
Sealing Kit V01 serial no. 11046999 and older	4013859		4013860	
Price (\$)	\$40		\$53	
Sealing Kit V01 serial no. 11047000 to 12438529	4013980		4013981	
Price (\$)	\$70		\$96	

Price Group 23

Replacement Alternative Filter Bag Sets for Oil-water Separators

- for a variety of competitive brands and models

	Order ref.	Price (\$)
Filter Set for Ultrafilter Superplus 5, Quincy QIOW 0005, Gardner Denver GDW5, BOGE Okomat 5 (Vent Filter Sold Separately = ZF3 kit)	2002294 4001791 (ZF3)	\$128 \$68
Filter Set for Ultrafilter Superplus 10, Quincy QIOW 0010, Gardner Denver GDW10, BOGE Okomat 10 (Vent Filter Sold Separately = ZF3 kit)	2000261 4001792 (ZF3)	\$169 \$85
Filter Set for Ultrafilter Superplus 15, Quincy QIOW 0015, Gardner Denver GDW15, BOGE Okomat 15 (Vent Filter Sold Separately = ZF3 kit)	2000262 4001793 (ZF3)	\$241 \$121
Filter Set for Ultrafilter Superplus 30, Quincy QIOW 0030, Gardner Denver GDW30, BOGE Okomat 30 (Vent Filter Sold Separately = ZF3 kit)	2000263 4001794 (ZF3)	\$400 \$195
Filter Set for Ultrafilter Superplus 60 / 120 / 240, Quincy QIOW 0060 / 0120 / 0240, Gardner Denver GDW60 / 120 / 240, BOGE Okomat 60 / 120 / 240 (120S Requires 2x 2000264, 240S Requires 4x 2000264, Vent Filter Sold Separately = ZF3 kit)	2000264 4001795 (ZF3)	\$550 \$260
Filter Set for Wortmann drukomat Mini and 1, Hankison HS1, Zander Ecosep 1 and 2	4015018	\$263
Filter Set for Wortmann drukomat 2, 3, 4 and 8, Hankison HS2, 3 and 4, Motivair OSW 2, 3 and 4, Zander Ecosep 3, 4 and 8	2000267	\$263
Filter Set for Wortmann drukomat 15, Hankison HS5, Motivair OSW 5, Zander Ecosep 15	2000269	\$366
Filter Set for Wortmann drukomat 30, Hankison HS6, Motivair OSW 6, Zander Ecosep 30	2000270	\$525
Filter Set for Wortmann drukomat 60, Hankison HS7, Motivair OSW 7, Zander Ecosep 60	2000271	\$949
Filter Set for domnick hunter ES 2100, Hi-Ross OWS 001, Zander Ecosep SL1, Comp-Air CS 2100, Ingersoll Rand ECS6, Sullair OS-1	4014218	\$207
Filter Set for domnick hunter ES 2150, Hi-Ross OWS 060, Zander Ecosep SL2, Comp-Air CS 2150, Ingersoll Rand ECS12, Sullair OS-16	4014218	\$207
Filter Set for domnick hunter ES 2200, Hi-Ross OWS 075, Zander Ecosep SL5, Comp-Air CS 2200, Ingersoll Rand ECS18, Sullair OS-20	4014218	\$207
Filter Set for domnick hunter ES 2300, Hi-Ross OWS 125, Zander Ecosep SL8, Comp-Air CS 2300, Ingersoll Rand ECS24, Sullair OS-33	4014234	\$254
Filter Set for domnick hunter ES 2400, Hi-Ross OWS 185, Zander Ecosep SL15, Comp-Air CS 2400, Ingersoll Rand ECS30, Sullair OS-1	4014235	\$426
Filter Set for domnick hunter ES 2500, Hi-Ross OWS 355, Zander Ecosep SL30, Comp-Air CS 2500, Ingersoll Rand ECS36, Sullair OS-16	4014236	\$299
Filter Set for domnick hunter ES 2600, Hi-Ross OWS 485, Zander Ecosep SL60, Comp-Air CS 2600, Ingersoll Rand ECS42, Sullair OS-1	4014237	\$620



Measurement Technology

METPOINT®

precision instruments for compressed air

- › Dew Point Meters
- › Flow Meters
- › Oil Vapor Measurement
- › Oil Vapor Monitoring Systems
- › Multi-Function Monitoring Systems
- › Portable Instrumentation and Monitoring Systems

METPOINT® DPMc Compact Dew Point Meter

pre-configured stationary compact pressure dew point meter

- › Self-contained pressure dew point sensor and single value display
- › Includes measuring chamber
- › 115-230 VAC / 50-60 Hz / 24 VDC power supply
- › Measurement range: -4 °F to 86 °F

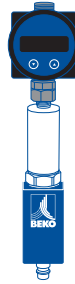

Maintenance Interval: < 8,000 hours
Maintenance and Spare Parts: Page 135
Extended Warranty: Page 144

Order ref.	4032656
Price (\$)	\$1,835

Price Group 95

METPOINT® DPMe Economy Dew Point Meter

pre-configured stationary economy pressure dew point meter

- › SD21 dew point sensor with measuring chamber
- › DD081 single value display, wall mountable
- › 115 VAC / 50-60 Hz power supply
- › Connection cable
- › Measurement range: -76 °F to 86 °F
- › 4-20ma output
- › 2 alarm contacts

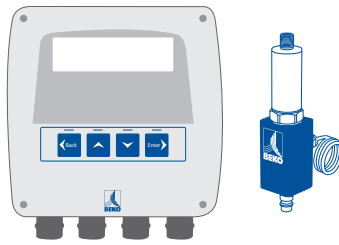

Maintenance Interval: < 8,000 hours
Maintenance and Spare Parts: Page 135
Extended Warranty: Page 144

Order ref.	4032012
Price (\$)	\$2,458

Price Group 95

METPOINT® DPMp Premium Dew Point Meter

pre-configured stationary premium pressure dew point meter



- › SD21 dew point sensor with measuring chamber
- › BDL Compact multi-function display, wall mountable
- › Full data log capabilities
- › 90 to 260 VAC / 50-60 Hz multi-voltage power supply
- › Connection cable
- › Measurement range: -76 °F to 86 °F
- › For custom configurations, see page 127

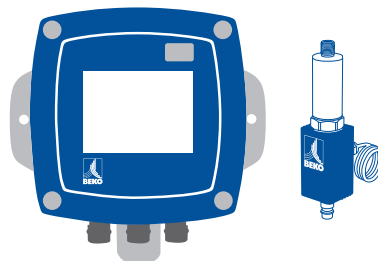

Maintenance Interval: < 8,000 hours
Maintenance and Spare Parts: Page 135
Extended Warranty: Page 144

Order ref.	4032013
Price (\$)	\$3,801

Price Group 95

OPTIONAL EQUIPMENT

Alarm Light and Siren with Wall Mount	4014684
Price (\$)	\$492
BDL Connect Basic Software (single-user)	4024218
Price (\$)	\$761
Compressed Air Analyzer Plug-in*	4036368
Price (\$)	\$1,353

*BDL Connect Software required

Price Group 95

METPOINT® FLMc Compact Flow Meter

stationary compact flow meter

- › SF13 compact flow meter
- › Measuring section with integrated digital display indicating actual flow and total consumption with built-in flow sensor
- › Multi-voltage power supply: 100-240 VAC / 24 VDC / 50-60 Hz

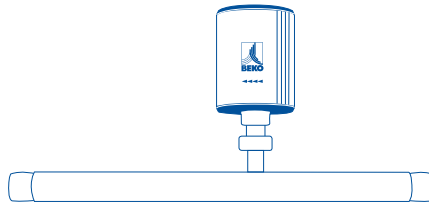

Maintenance Interval: < 8,000 hours
Maintenance and Spare Parts: Page 135
Extended Warranty: Page 144

Connection Size (NPT)	½"	¾"	1"	1¼"	1½"	2"
Flow Rate (scfm)	.12-53	.18-100	.29-170	.41-312	.59-430	1.18-703
Order ref.	4038526	4038528	4038529	4038530	4038531	4038532
	Price (\$)	\$1,523	\$1,610	\$1,646	\$1,961	\$2,063

Price Group 95

METPOINT® FLMe Economy Flow Meter

pre-configured stationary economy flow meter

- › SF53 maximum speed flow sensor with adjustable probe for up to a 10" pipe
- › DD081 single value display, wall mountable
- › 115 VAC / 50-60 Hz power supply
- › Connection cable
- › 4-20ma output
- › 2 alarm contacts

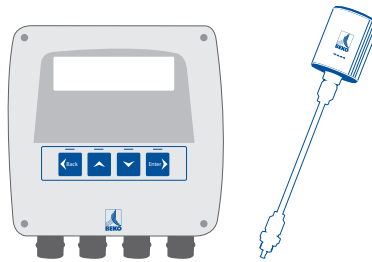

Maintenance Interval: < 8,000 hours
Maintenance and Spare Parts: Page 135
Extended Warranty: Page 144

Order ref.	4032014
Price (\$)	\$4,717

Price Group 95

METPOINT® FLMp Premium Flow Meter

pre-configured stationary premium flow meter



- › SF53 maximum speed flow sensor with adjustable probe for up to a 10" pipe
- › BDL Compact multi-function display, wall mountable
- › Full data log capabilities
- › Multi-voltage power supply: 90 to 260 VAC / 50-60 Hz
- › Connection cable
- › For custom configurations, see page 127

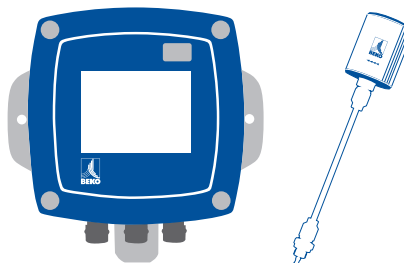

Maintenance Interval: < 8,000 hours
Maintenance and Spare Parts: Page 135
Extended Warranty: Page 144

Order ref.	4032015
Price (\$)	\$5,990

Price Group 95

OPTIONAL EQUIPMENT

Alarm Light and Siren with Wall Mount	4014684
Price (\$)	\$492
BDL Connect Basic Software (single-user)	4024218
Price (\$)	\$761
Compressed Air Analyzer Plug-in*	4036368
Price (\$)	\$1,353

*BDL Connect Software required

Price Group 95

METPOINT® BDL Compact Multi-Function Monitoring Systems

pre-configured solution for dew point and pressure



- › BDLc 2A multi-function display, wall mountable
- › SD 21 Dew point sensor
- › SP 21 Pressure sensor
- › 30' cables for sensors

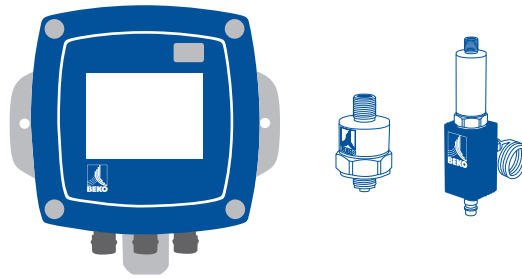

Maintenance Interval (sensors): < 8,000 hours

Maintenance and Spare Parts: Page 135

Extended Warranty: Page 144

Order ref.	4048946
Price (\$)	\$4,266

Price Group 95

METPOINT® BDL Compact Multi-Function Monitoring Systems

pre-configured solution for dew point and flow rate



- › BDLc 2D multi-function display, wall mountable
- › SD 23 Dew point sensor
- › SF 53 Flow sensor
- › 30' cables for sensors

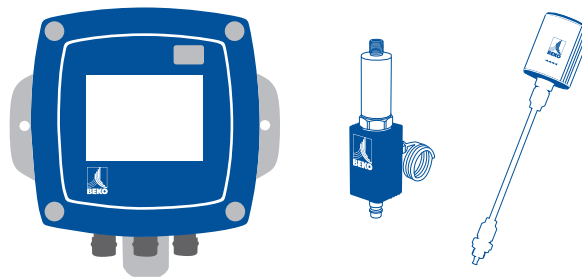

Maintenance Interval (sensors): < 8,000 hours

Maintenance and Spare Parts: Page 135

Extended Warranty: Page 144

Order ref.	4048950
Price (\$)	\$7,925

Price Group 95

METPOINT® BDL Compact Multi-Function Monitoring Systems

pre-configured solution for dew point, flow rate, and pressure



- › BDLc 2A2D multi-function display, wall mountable
- › SD 23 Dew point sensor
- › SF 53 Flow Sensor
- › SP 21 Pressure sensor
- › 30' cables for sensors

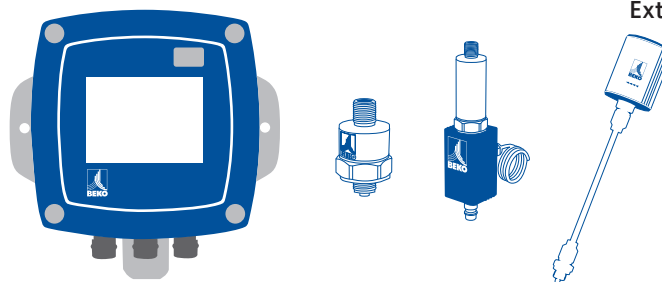

Maintenance Interval (sensors): < 8,000 hours

Maintenance and Spare Parts: Page 135

Extended Warranty: Page 144

Order ref.	4048952
Price (\$)	\$8,887

Price Group 95

METPOINT® BDL Compact Multi-Function Monitoring Systems

custom configurations for 1–4 sensor connections



- › Compact, easy to read, touch screen display
- › Expandable and future-proof via expansion modules
- › Full data log capabilities
- › Optional integration and analysis software available
- › Fully assembled and ready to use

Maintenance Interval (sensors): < 8,000 hours

Maintenance and Spare Parts: Page 135

Extended Warranty: Page 144

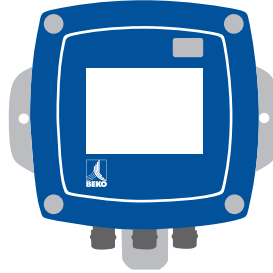

Custom Configuration Legend

- Required Equipment Selections
- Expansion and Equipment Options

		BDL 2A		BDL 4A		BDL 2D2A		BDL 2D		BDL 4D	
		2 Analog Sensor Configuration		4 Analog Sensor Configuration		2 Analog / 2 Digital Sensor Configuration		2 Digital Sensor Configuration		4 Digital Sensor Configuration	
1	Select Monitor Type	Order ref.	Price (\$)	Order ref.	Price (\$)	Order ref.	Price (\$)	Order ref.	Price (\$)	Order ref.	Price (\$)
	BDL without Ethernet	4029266	\$2,341	4029406	\$2,967	4029278	\$2,967	4029262	\$2,341	4029409	\$2,967
	BDL with Ethernet	4029270	\$2,838	4029315	\$3,464	4029299	\$3,464	4029286	\$2,838	4029311	\$3,464
2	Select Sensors including 30' cable										
	SD21 Dew Point Sensor with Chamber -76 °F	4032333	\$1,623	4032333	\$1,623	4032333	\$1,623	-	-	-	-
	SD23 Dew Point Sensor with Chamber -76 °F	-	-	-	-	4032334	\$1,857	4032334	\$1,857	4032334	\$1,857
	SD41 Dew Point Sensor with Chamber -148 °F	4048188	\$2,608	4048188	\$2,608	4048188	\$2,608	-	-	-	-
	SF53 Flow Sensor up to 10" pipe	4039145	\$3,774	4039145	\$3,774	4039145	\$3,774	4039145	\$3,774	4039145	\$3,774
	SP21 Pressure Sensor: 0 to 360 psig	4024284	\$349	4024284	\$349	4024284	\$349	-	-	-	-
	SP61 Pressure Sensor: 0 to 870 psig	4024286	\$349	4024286	\$349	4024286	\$349	-	-	-	-
	TS109 Temperature Sensor	4044639	\$645	4044639	\$645	4044639	\$645	-	-	-	-
	AS109 Ampmeter with 5m cable	4014731	\$1,018	4014731	\$1,018	4014731	\$1,018	-	-	-	-
	METPOINT® OCV Compact	4040025	\$12,519	4040025	\$12,519	4040025	\$12,519				
3	Optional Software										
	BDL Connect Basic (single-user license)	4024218	\$761	4024218	\$761	4024218	\$761	4024218	\$761	4024218	\$761
4	Options										
	Alarm Light and Siren with Wall Mount	4014684	\$492	4014684	\$492	4014684	\$492	4014684	\$492	4014684	\$492
	Webserver	4027872	\$635	4027872	\$635	4027872	\$635	4027872	\$635	4027872	\$635
	Virtual Channels - Math Function	4027873	\$382	4027873	\$382	4027873	\$382	4027873	\$382	4027873	\$382

METPOINT® BDL XL Multi-Function Monitoring Systems

pre-configured solution for dew point and pressure

- › BDL XL4 multi-function display, wall mountable
- › SD 23 Dew point sensor
- › 2 x SP 21 Pressure sensors
- › BDL connect basic software (Single user)
- › 30' cables for sensors

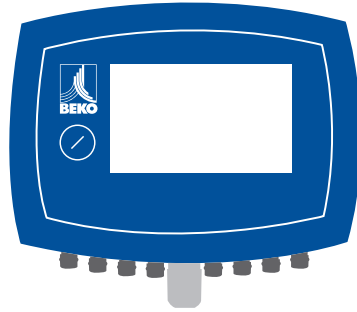

Maintenance Interval (sensors): < 8,000 hours

Maintenance and Spare Parts: Page 135

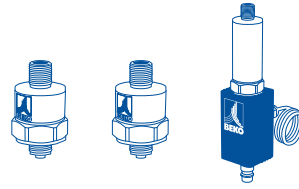

Order ref.	4048954
Price (\$)	\$7,995

Price Group 95

METPOINT® BDL XL Multi-Function Monitoring Systems

pre-configured solution for dew point, flow rate, and pressure

- › BDL XL4 multi-function display, wall mountable
- › SD 23 Dew point sensor
- › SF 53 Flow sensor
- › 2 x SP 21 Pressure sensors
- › BDL connect basic software (single user)
- › 30' cables for sensors

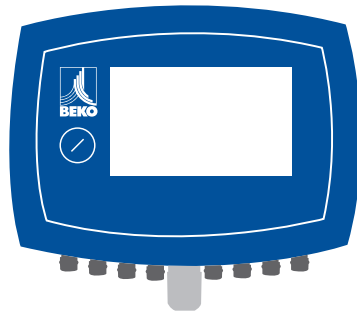

Maintenance Interval (sensors): < 8,000 hours

Maintenance and Spare Parts: Page 135

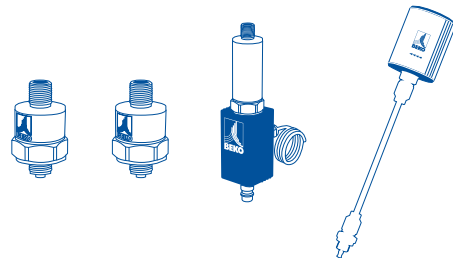

Order ref.	4048955
Price (\$)	\$11,768

Price Group 95

METPOINT® BDL XL Multi-Function Monitoring Systems

pre-configured solution for oil vapor measurement

- › BDL XL4 multi-function display, wall mountable
- › OCV Compact
- › BDL connect basic software (single user)
- › 30' cable for sensor

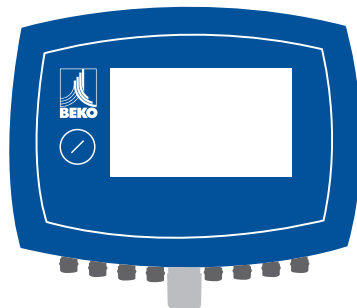

Maintenance Interval (sensors): < 8,000 hours

Maintenance and Spare Parts: Page 135

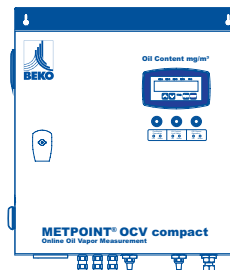

Order ref.	4048958
Price (\$)	\$20,047

Price Group 95

METPOINT® BDL XL Multi-Function Monitoring Systems

custom configurations for up to 12 sensor connections with a single display

- › Extra large, easy to read, touch screen display
- › Full data log capabilities
- › Sensor ports work with both analog and digital sensors
- › Easy integration with existing systems
- › Network ready
- › Optional integration and analysis software available

Maintenance Interval (sensors): < 8,000 hours

Maintenance and Spare Parts: Page 135

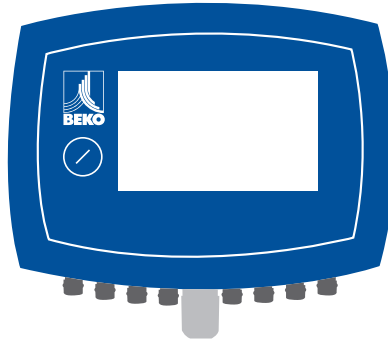

Custom Configuration Legend

- Required Equipment Selections
- Equipment Options

	BDL XL4 4-Port Multi-use Sensor Configuration		BDL XL8 8-Port Multi-use Sensor Configuration		BDL XL12 12-Port Multi-use Sensor Configuration	
	Order ref.	Price (\$)	Order ref.	Price (\$)	Order ref.	Price (\$)
1 Select Monitor Type						
BDL XL with Ethernet	4055589	\$3,979	4055590	\$4,895	4055591	\$5,729
2 Select Sensors including 30' cable						
SD21 Dew Point Sensor with Chamber -76 °F	4032333	\$1,623	4032333	\$1,623	4032333	\$1,623
SD23 Dew Point Sensor with Chamber -76 °F	4032334	\$1,857	4032334	\$1,857	4032334	\$1,857
SD41 Dew Point Sensor with Chamber -148 °F	4048188	\$2,608	4048188	\$2,608	4048188	\$2,608
SF53 Flow Sensor up to 10" pipe	4039145	\$3,774	4039145	\$3,774	4039145	\$3,774
SP21 Pressure Sensor: 0 to 360 psig	4024284	\$349	4024284	\$349	4024284	\$349
SP61 Pressure Sensor: 0 to 870 psig	4024286	\$349	4024286	\$349	4024286	\$349
TS109 Temperature Sensor	4044639	\$645	4044639	\$645	4044639	\$645
AS109 Ampmeter with 5m cable	4014731	\$1,018	4014731	\$1,018	4014731	\$1,018
METPOINT® OCV Compact	4040025	\$12,519	4040025	\$12,519	4040025	\$12,519
3 Optional Software						
BDL Connect Basic (single-user license)	4024218	\$761	4024218	\$761	4024218	\$761
4 Options						
Alarm Light and Siren with Wall Mount	4014684	\$492	4014684	\$492	4014684	\$492
Webserver	4027872	\$635	4027872	\$635	4027872	\$635
Quick Measurement	4024295	\$310	4024295	\$310	4024295	\$310
Virtual Channels - Math Function	4027873	\$382	4027873	\$382	4027873	\$382

METPOINT® OCV Compact Oil Vapor Monitoring Systems

inline oil vapor measurement device with integrated display



- › Measurement range:
 - ≤ .01 - 2.50 mg/m³ residual oil vapor content
- › Power supply: 100-240 VAC / 50-60 Hz
- › Connection: 1/8" internal thread
- › Outputs: 4-20 mA analog, RS-485, MODBUS RTU
- › Min. / max. operating temperature: 41 °F / 113 °F
- › Min. / max. operating pressure: 44 / 232 psig

Maintenance Interval: < 8,000 hours
 Maintenance and Spare Parts: Page 135
 Extended Warranty: Page 144

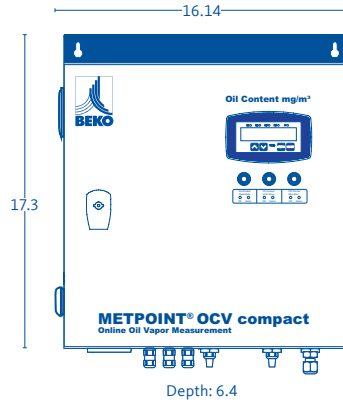

STANDARD PRESSURE

METPOINT® OCV Compact with 4-20 mA Output	4040025
Price (\$)	\$12,519

Price Group 96

OPTIONAL EQUIPMENT

High Pressure Adapter Kits for Systems up to 580 psig	Consult Factory
Price (\$)	ON REQUEST
Installation Kit	Consult Factory
Price (\$)	ON REQUEST

Price Group 96

METPOINT® OCV Accessories

- accessories for 580 psig applications

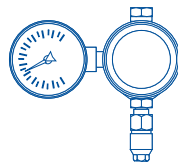

	Pressure Reducer	Ball Valve
Order ref.	4014084	4014394
Price (\$)	\$1,806	\$682

Price Group 96

METPOINT® DPM Portable

portable dew point measurement instrument

Includes:

- › Handheld display with integrated SD23 PDP sensor
- › Integrated data log
- › Measurement range:
 - Pressure Dew Point -76 °F to 86 °F
 - Temperature: -22 °F to 158 °F
 - Relative Humidity: 0-95%
- › 11.3% RH control and calibration set
- › Connection cable
- › Carrying case

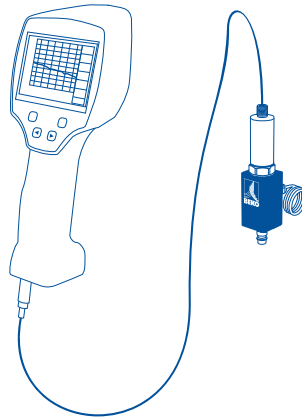

Maintenance Interval (sensor): < 8,000 hours

Maintenance and Spare Parts: Page 135

Extended Warranty: Page 144

Order ref.	4031162
Price (\$)	\$4,800

Price Group 95

OPTIONAL EQUIPMENT

BDL Connect Basic (single-user)	4024218
Price (\$)	\$761

Price Group 95

METPOINT® FLM Portable

portable flow rate measurement instrument

Includes:

- › Handheld display prepared for SF53 flow sensor
- › Integrated data log
- › Adjustable probe up to 10" pipe
- › Connection cable
- › Carrying case

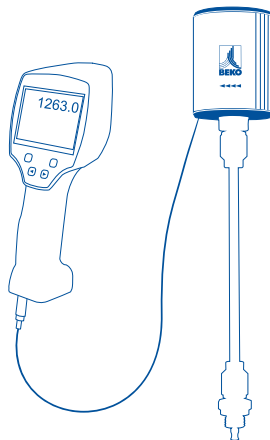

Maintenance Interval (sensor): < 8,000 hours

Maintenance and Spare Parts: Page 135

Extended Warranty: Page 144

Order ref.	4032016
Price (\$)	\$6,785

Price Group 95

OPTIONAL EQUIPMENT

BDL Connect Basic (single-user)	4024218
Price (\$)	\$761

Price Group 95

METPOINT® PRO Portable

portable multi-function compressed air monitoring device

Includes:

- › Intelligent handheld device prepared for a variety of sensor attachments
- › Integrated data log
- › 100 to 240 VAC multi-voltage power supply
- › Integrated data logger

Compatible sensors (sold separately):

- › SD21, SD23, and SD41 pressure dew point sensors
- › SP21 and SP61 pressure sensors
- › SF53 or SF13 flow sensor
- › And many more
- › See page 127 for all available sensors

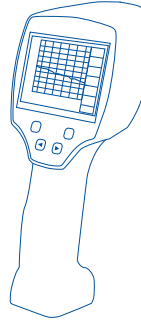

No maintenance required
Extended Warranty: Page 144

Order ref.	4028336
Price (\$)	\$2,193

Price Group 95

OPTIONAL EQUIPMENT

BDL Connect Basic (single-user)	4024218
Price (\$)	\$761

Price Group 95

METPOINT® CID

portable compressed air leak detection instrument

- › Headphones and spiral cable
- › Sound funnel and straightening tip attachment (exchangeable)
- › Holster with shoulder strap
- › Charger
- › Leak Tag (notepad)
- › Evaluation PC software "Leak Management Software"
- › Rugged carrying case

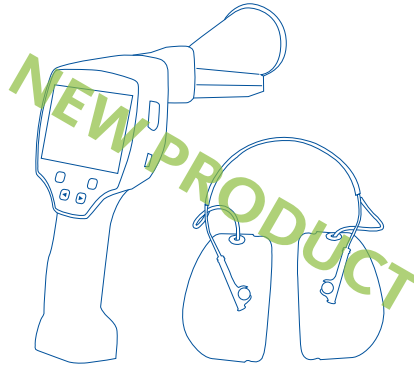

No maintenance required
Extended Warranty: Page 144

Order ref.	4055748
Price (\$)	\$8,249

Price Group 95

METPOINT® CID Accessories

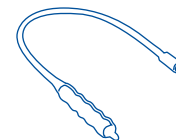
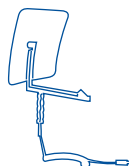

	Parabolic Microphone	Gooseneck Microphone
Order ref.	4055749	4055747
Price (\$)	\$2,890	\$860

Price Group 96

METPOINT® Maintenance

■ calibration and rental services

Maintenance Interval: < 8,000 hours

DEW POINT SENSORS

DPM Annual Calibration for SD11 Sensor	4032067
Price (\$)	\$341
DPM Annual Calibration for SD21 Sensor	4032069
Price (\$)	\$341
DPM Annual Calibration for SD23 Sensor	4032071
Price (\$)	\$341
DPM Annual Calibration for DP109 Sensor	4027629
Price (\$)	\$341
DPM Annual Calibration for SD31 Sensor	4048621
Price (\$)	\$678
DPM Annual Calibration for DP207 Sensor	4027631
Price (\$)	\$341
DPM Annual Calibration for SD41 Sensor	4048612
Price (\$)	\$1,417

Price Group 96

DPM SD21 Sensor Rental During Calibration / per week (max. 8-weeks)	4048616
Price (\$)	\$113
DPM SD23 Sensor Rental During Calibration / per week (max. 8-weeks)	4048615
Price (\$)	\$113
DPM SD41 Sensor Rental During Calibration / per week (max. 8-weeks)	4049012
Price (\$)	\$228

Price Group 96

PRESSURE SENSORS

PRM Annual Calibration for SP11, SP21, SP23 Pressure Sensors	4034020
Price (\$)	\$313

Price Group 96

FLOW SENSORS

FLM Annual Calibration for SF13, SF53 Flow Sensors	4036453
Price (\$)	\$1,126
FLM Annual Calibration for FS109 Flow Sensor	4013058
Price (\$)	\$934

Price Group 96

FLM SF53 Sensor Rental During Calibration / per week (max. 8-weeks)	4048617
Price (\$)	\$207

Price Group 96

OCV SENSORS

OCV Annual Calibration	4025003
Price (\$)	\$3,198
OCV Compact Annual Calibration	4040662
Price (\$)	\$3,407

Price Group 96

OCV Sensor Rental During Calibration / per week (max. 8-weeks)	4048618
Price (\$)	\$351
OCV Compact Sensor Rental During Calibration / per week (max. 8-weeks)	4048619
Price (\$)	\$351

Price Group 96

PARTICLE COUNTER

PC400 Particle Counter Annual Calibration	4040408
Price (\$)	\$3,411

Price Group 96

METPOINT® Spare Parts

■ replacement displays

	Order ref.	Price (\$)
Replacement BDL 2A without Ethernet	4029266	\$2,341
Replacement BDL 2A with Ethernet	4029270	\$2,838
Replacement BDL 4A without Ethernet	4029406	\$2,967
Replacement BDL 4A with Ethernet	4029315	\$3,464
Replacement BDL 2D2A without Ethernet	4029278	\$2,967
Replacement BDL 2D2A with Ethernet	4029299	\$3,464
Replacement BDL 2D without Ethernet	4029262	\$2,341
Replacement BDL 2D with Ethernet	4029286	\$2,838
Replacement BDL 4D without Ethernet	4029409	\$2,967
Replacement BDL 4D with Ethernet	4029311	\$3,464

Price Group 95

METPOINT® Spare Parts

■ replacement sensors and sensor parts

	Order ref.	Price (\$)
SD21 Pressure Dew Point Sensor without Chamber -76° F	4024282	\$1,138
SD23 Pressure Dew Point Sensor without Chamber -76° F	4024283	\$1,320
SD41 Pressure Dew Point Sensor without Chamber -148 °F	4051577	\$2,367
Bonded Sealing Washer for Dew Point Sensors	4027443	\$33
SF53 Flow Sensor: 185.0 m/s with 8.66" Standard Probe Length	4039145	\$3,774
SF53 Flow Sensor: 185.0 m/s with 15.75" Standard Probe Length	4039146	\$4,045
SP21 mA Pressure Sensor: 0 to 360 psig	4024284	\$349
SP61 mA Pressure Sensor: 0 to 870 psig	4024286	\$349
TS109 Temperature Sensor	4044639	\$645
AS109 Ampmeter with 15' Cable	4014731	\$1,018
Standard Cable for Handheld Displays: SF Sensor Cable 15'	4039570	\$78
Standard Cable for Handheld Displays: Open End	4028338	\$238
Measurement Chamber	4029196	\$317
OCV Replacement Probe 2" to 3" pipes	4013237	\$687
OCV 4 - 20 mA Cable Plug with M16 Connection	4014143	\$88

Price Group 95

METPOINT® Spare Parts

■ replacement cables

	15' Cables		30' Cables		80' Cables	
Sensors SP21, SP11, SP61 and SD21	4025252	\$44	4034219	\$55	4034220	\$105
Sensors SF13 and SF53	4014064	\$57	4014065	\$74	4020081	\$136
Sensor SD23	4025253	\$107	4033570	\$195	4033571	\$243
Sensor OCV Compact (open ended cable)	4017332	\$90	4017333	\$158	4048189	\$292



Advanced Catalytic Systems

BEKOKAT®

for oil-free and germ-free compressed air

› Complete Catalytic Conversion Systems

BEKOKAT® Catalytic Conversion Systems

complete oil and bacteria removal systems for compressed air

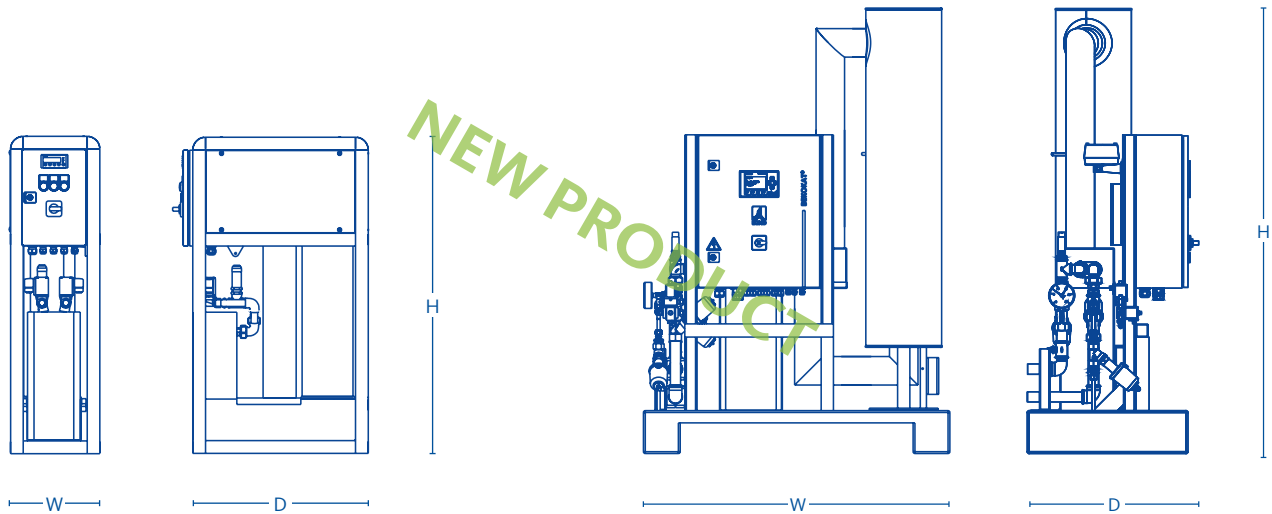

BEKOKAT®	iCC 010	iCC 035	iCC 070
Flow Rate (scfm)	10	35	70
Pipe Size (NPT)	1/2"	1"	1"
Voltage (VAC)	230 V / 1 Ph	230 V / 1 Ph	230 V / 1 Ph
Installed power (kW)	0.58	1.00	1.64
Average Power (kW)	0.20	0.52	0.86
Dimensions and Weight			
H x W x D (inches)	39 x 11 x 24	57 x 40 x 22	60 x 40 x 22
Weight (lbs)	135	309	386

Order ref.	4046760	4052718	4052419
Price (\$)	\$9,652	\$19,424	\$21,448

Price Group 45

REQUIRED INLET WATER SEPARATOR

Order ref.	4005005	4004735	4004736
Price (\$)	\$225	\$248	\$325

Price Group 82

OPTIONAL 1 µm PRE-FILTRATION

Order ref.	4015378	4005492	4005841
Price (\$)	\$287	\$352	\$439

Price Group 82

OPTIONAL EQUIPMENT

Bypass valve, mounted and tested	4043063	4025315	4025315
Price (\$)	\$1,465	\$1,689	\$1,689

Price Group 82

The residual oil content can be monitored continuously using the METPOINT® OCV Compact. When installing the BEKOKAT® downstream of a compressor with aftercooler, a water separator needs to be installed. Please consult our technical department before ordering.

- › Attainable residual oil at outlet: $\leq .003 \text{ mg/m}^3$
- › Oil-free air independent from ambient conditions
- › Produces germ-free, sterile air
- › ISO 8573-1, Class 1 certified
- › Min. / max. ambient conditions: 41 °F / 113 °F
- › Min. / max. inlet air temperature: 41 °F / 131 °F
- › Max. operating pressure: CC 035-425: 232 psig | CC10 & iCC 705: 160 psig

Maintenance Interval: < 8,000 hours
 Maintenance and Spare Parts: Page 140
 Extended Warranty: Page 144

BEKOKAT®	iCC 105	iCC 210	iCC 425	iCC 705
Flow Rate (scfm)	105	210	425	705
Pipe Size (NPT)	1¼"	1½"	2"	2½"
Voltage (VAC)	460 V / 3 Ph	460 V / 3 Ph	460 V / 3 Ph	460 V / 3Ph
Installed power (kW)	2.64	5.14	8.74	13.84
Average Power (kW)	1.33	2.17	3.26	3.75
Dimensions and Weight				
H x W x D (inches)	60 x 40 x 22	49 x 69 x 28	75 x 60 x 30	69 x 80 x 36
Weight (lbs)	441	717	1,169	1,636

Order ref.	4052719	4051082	4051081	4052720
Price (\$)	\$26,841	\$35,522	\$50,868	\$70,048

Price Group 45

REQUIRED INLET WATER SEPARATOR

Order ref.	4020397	4012257	4020440	4012260
Price (\$)	\$575	\$973	\$1,130	\$2,506

Price Group 82

OPTIONAL 1 µm PRE-FILTRATION

Order ref.	4020387	4016030	4020430	4003493
Price (\$)	\$492	\$769	\$974	\$2,180

Price Group 82

OPTIONAL EQUIPMENT

Bypass valve, mounted and tested	4025315	4037946	4037947	4037587
Price (\$)	\$1,689	\$2,179	\$2,463	\$3,849

Price Group 82

Correction Factors

Operating Pressure (psig)	20	40	60	80	90	100	110	120	130	140	160	180	200	230
Correction Factor	.30	.48	.65	.82	.91	1.00	1.09	1.17	1.26	1.35	1.52	1.70	1.87	2.13

The correction factors on this page provide an estimation of the performance that can be achieved with the model sizes shown. For precise sizing for your application, please contact your BEKO Technologies sales representative.

BEKOKAT® Maintenance

- replacement catalyst material for current and previous generations

Maintenance Interval: 24,000 hours

	iCC 035	iCC 070	iCC 105	iCC 210	iCC 425	iCC 705
Order ref.	4024471	4024472	4024473	4024474	4024475	4024476
Price (\$)	\$997	\$2,622	\$3,981	\$7,235	\$15,371	\$31,282

Price Group 45

BEKOKAT® Spare Parts

- for all model sizes and generations

	iCC / CC 035	iCC / CC 070	iCC / CC 105	
			up to serial no. CC180.07.051191	from serial no. CC180.07.0212118
Compressed Air Distributor	4024538	4024538	4024538	
Price (\$)	\$311	\$311	\$311	
Safety Valve 232 psi	4024552	4024552	4024552	
Price (\$)	\$181	\$181	\$181	
Electrical Inlet Valve	4024995	4024995	4024995	-
Price (\$)	\$812	\$812	\$812	-
Electrical Outlet Valve	4024996	4024996	4024996	-
Price (\$)	\$1,085	\$1,085	\$1,085	-
Pneumatic Inlet Valve	-	-	-	4025420
Price (\$)	-	-	-	\$409
Pneumatic Outlet Valve	-	-	-	4025421
Price (\$)	-	-	-	\$492
Pilot Valve	-	-	-	4026827
Price (\$)	-	-	-	\$543

Price Group 45

	iCC / CC 210		iCC / CC 425		iCC / CC 705
	up to serial no. CC360.07.091080	from serial no. CC360.07.091081	up to serial no. CC720.07.061075	from serial no. CC720.07.101086	
Compressed Air Distributor	4024539		4025195		4026828
Price (\$)	\$347		\$543		\$630
Safety Valve 160 psi	-		-		4026829
Price (\$)	-		-		\$654
Safety Valve 174 psi	4024553	-	4024553	-	-
Price (\$)	\$373	-	\$373	-	-
Safety Valve 232 psi	-	4024552	-	4024552	-
Price (\$)	-	\$181	-	\$181	-
Electrical Inlet Valve	-		-		-
Price (\$)	-		-		-
Electrical Outlet Valve	-		-		-
Price (\$)	-		-		-
Pneumatic Inlet Valve	-	4025422	-	4025427	4026825
Price (\$)	-	\$705	-	\$769	\$1,591
Pneumatic Outlet Valve	-	4025423	-	4025428	4026826
Price (\$)	-	\$794	-	\$877	\$1,759
Pilot Valve	-	4026827	-	4026827	4026827
Price (\$)	-	\$543	-	\$543	\$543

Price Group 45

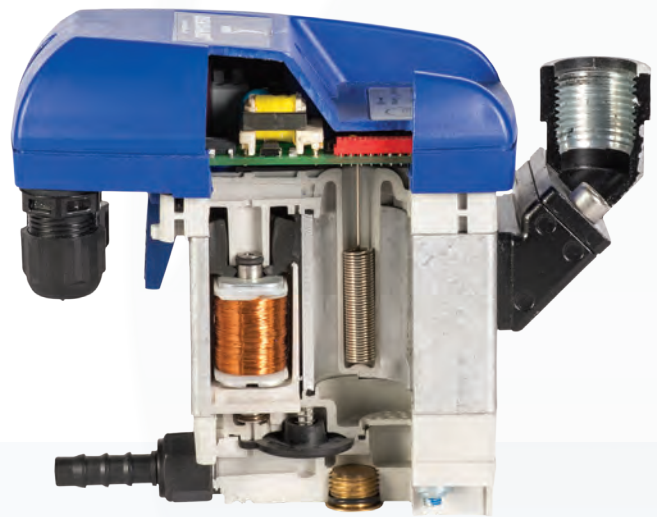

Education and Training

Courses and Products

providing professional knowledge about the industry

- › Industry Specific Training Courses
- › Air Treatment Cutaways
- › Condensate Technology Cutaway and Demo Products with Carrying Case
- › Instrumentation Demo Products with Carrying Case

Industry Training and Demo Products

highly applicable, useful and easy to understand courses and products



online, self-paced compressed air course covering compressed air basics, principles of filtration, drying, pressure dew point, and more

2-day EPA 608 certification class including all study materials, proctored exam, and certification card upon successful completion

Training	Course Offering	
Order ref.	Contact Your Regional Sales Manager	Contact Our Technical Service Department
Net Price (\$)	FREE	\$649 per person



cutaway of CLEARPOINT® filter with element and stand



cutaway of filter element with stand



cutaway of aluminum heat exchanger profile with stand



cutaway of hot gas bypass valve



cutaway of DRYPOINT® MDp with integrated pre-filter

Air Treatment	CLEARPOINT® Filtration		DRYPOINT® RA Refrigerant Dryer		DRYPOINT® M Membrane Dryer
Order ref.	4002785	4040053	4041105	4041106	4009819
Net Price (\$)	\$145	\$125	\$197	\$119	\$514



cutaway of BEKOMAT® 32 multi-voltage zero air loss drain



set of BEKOMAT® 3x series drains with one 31, one 32 cutaway, one 33 and universal heating kit in hard shell carrying case

Condensate Technology	BEKOMAT® Condensate Drains	
Order ref.	4024398	Contact Your Regional Sales Manager
Net Price (\$)	\$479	\$912



fully functioning touch screen display with data log, pressure dew point sensor and cables with hard shell carrying case



fully functioning touch screen display with data log, flow sensor and cables with hard shell carrying case

Instrumentation	METPOINT® BDL and Sensor Packages	
Order ref.	4054653	4047594
Net Price (\$)	\$2,138	\$3,131

Commercial Information

Extended Warranty Program Terms and Conditions

+3
Years on all
Products

ask your
**sales
representative**
for complete details
and extend your full
warranty today



At a Glance

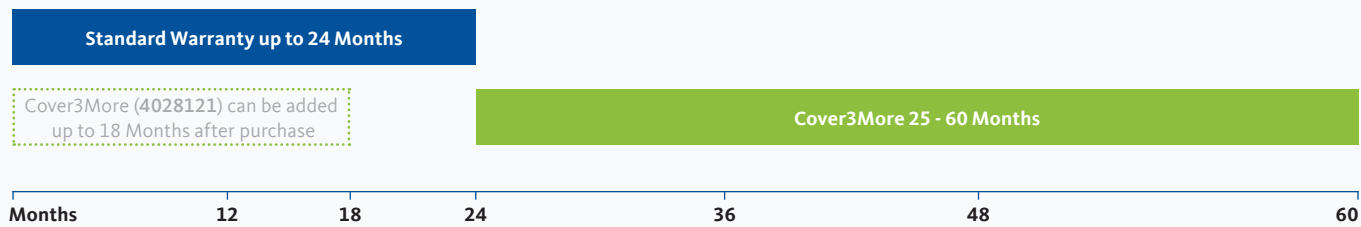

Cover3More is available on all our product lines

DRYPOINT® RA	Refrigerant Air Dryers	BEKOMAT®	Zero Air Loss Drains
DRYPOINT® X / AC	Desiccant Air Dryers	QWIK-PURE®/ÖWAMAT®	Oil-water Separators
DRYPOINT® M	Membrane Air Dryers	METPOINT®	Instrumentation
CLEARPOINT®	Filters and Water Separators	BEKOKAT®	Hydrocarbon Removal Systems

How it Works

1. Select the product or products that you wish to cover with the extended warranty.
2. Simply add 8% to the net price of each product or call your sales representative if you need help calculating your final net price.
3. Include order reference number **4028121** as a line item with your purchase order or purchase the warranty extension up to 18-months post-sale.

What we need from you: It's not much. In fact, if you are purchasing the Cover3More extended warranty with a new equipment purchase, all you have to do is include a line item on your order indicating which items you wish you cover, and we will take care of the rest. If you happen to be adding coverage to a product you've already taken delivery of, then all we need is the company name and contact information of the original purchaser, the product model number of the product to be covered, serial number, and original purchase order number or BEKO Technologies invoice number, and we will apply coverage appropriately. **Please feel free to contact us at +1 (800) 235-6797 to get started.**

All maintenance procedures, including filter element changes, must be carried out in accordance with the manual in order to maintain any warranty.

Terms and Conditions

the following terms and conditions of sale govern all purchases from BEKO Technologies, Corp. ("BEKO USA")

1. Price/Delivery.

All prices are "ex-works" BEKO USA's place of business and are exclusive of transportation costs, insurance, and applicable taxes. Title and risk of loss or damage pass upon tender of delivery of the product to the carrier. BEKO USA will arrange for transportation and insurance at Buyer's expense. The shipping date is an estimate and is subject to change by BEKO USA. The price stated includes only the product specified and is firm only for the period stated. Taxes shall be the responsibility of Buyer.

2. Acceptance.

All orders are subject to acceptance by BEKO USA at its place of business.

3. Delays.

BEKO USA will not be responsible or liable for any loss, damage, or delay caused or occasioned by acts of God, transportation delays, accidents, fire, strike, civil or military authority, by the requirements of any statute, order, or directive of any government authority, or by any other cause beyond BEKO USA's reasonable control.

4. Inspection.

Buyer shall promptly inspect the products upon receipt and shall notify BEKO USA in writing of any nonconformity or defect within 10 days after receipt by Buyer. In the event Buyer does not act within the time limit, Buyer agrees that it shall be conclusively presumed to have accepted the products and to have waived any defect discoverable upon reasonable inspection. Where any tender of delivery by BEKO USA is rejected by Buyer as a result of a non-conformity or defect, BEKO USA may seasonably notify the Buyer of BEKO USA's intention to cure and may then make a conforming delivery within a reasonable time, said reasonable time to be at least thirty (30) days following receipt of notice of Buyer that the goods are non-conforming or defective.

5. Payment/Security Interest.

Unless otherwise stated herein, the purchase price shall be payable to BEKO USA in U.S. dollars at BEKO USA's place of business, net 30 days from the invoice date. Amounts not paid when due will bear a late payment charge of 1.5% per month after 30 days. Buyer grants BEKO USA a purchase money security interest in the products and any proceeds thereof, as security for Buyer's obligation to pay the purchase price, and Buyer agrees to execute any financing statement or other instrument required to perfect such security interest. Buyer hereby agrees to BEKO USA's Terms and Conditions on the reverse side of the Invoice and grants BEKO USA a security interest, as defined by Article 9 of the Uniform Commercial Code, in the goods shipped by BEKO USA.

6. Warranty / Disclaimer.

All products manufactured by BEKO USA are warranted to the original buyer, for a period of 24-months. The warranty period begins on the date of shipment or upon final installation of product at BEKO USA's discretion. The products are warranted to be free of any defects in materials and workmanship, which render the products unfit for their intended use, and to conform to their specifications provided. Any warranty coverage including any extended warranty requires that all maintenance procedures, including filter element changes, must be carried out in accordance with the manual in order to maintain warranty coverage. For product lines DRYPOINT® RA, RA HT, RA LC and RS HP the warranty coverage is only provided if the following mandatory requirement is fulfilled: a CLEARPOINT® coalescing filter, Type-F [1 micron] or Type-S [0.01 micron] as manufactured by BEKO USA, must be installed directly at the inlet of the dryer. For product lines DRYPOINT® M, X and AC the warranty coverage is only provided if the following mandatory requirement is fulfilled: a CLEARPOINT® coalescing filter, Type-S [0.01 micron] as manufactured by BEKO USA, must be installed directly at the inlet of the dryer. For product lines DRYPOINT® RA, RA HT, RA LC and RS HP the heat exchanger is warranted to the original buyer, for a period of 60-months from the date of shipment or upon final installation of product at BEKO USA's discretion. The heat exchanger is warranted to be free of any defects in materials and workmanship, which render the heat exchanger to fail in its intended use or to conform to the original specifications provided. BEKO USA maintains, at their discretion, the option to offer the same warranty on the aforementioned product lines where no filter is present or another manufacturer's filter has been employed, provided that the previously stated performance and installation requirements, as well as the product quality standards of BEKO USA, have been met. The standard 24-month warranty for all products consists of a full warranty which includes parts and labor. The standard 60-month warranty specific to refrigerant air dryer heat exchangers consists of a full warranty which includes parts and labor. Labor costs are limited to a maximum hourly rate of \$85 (85 USD) and limited to certain maximum time allowances that have been predetermined by BEKO USA for a variety of specific maintenance and repair tasks. Incidental costs are not included. Refer to the [Technical Service Support and Warranty Policy](#), which is available for your review by accessing the hyperlink provided above or obtained as an electronic copy from the Technical Service section of [BEKO USA's official website](#). This Policy shall provide you with comprehensive information regarding product warranties, procedures, and reimbursement.

The optional 36-month warranty extension (i.e. Cover3More) is a limited extended warranty that covers parts only from months 25-60 and the extension does not apply to refrigerant air dryer heat exchangers. All of the aforementioned installation, performance, and quality requirements, however, must still be met in order to maintain extended warranty coverage. Failure to do so will render all warranties null and void. The limited extended warranty coverage may be purchased and applied to any of the BEKO USA product lines included in the scope of the Cover3More extended warranty program from the original date of sale up to 18-months thereafter. Extended warranty coverage may not be purchased during the final 6-months of the standard warranty coverage, which are months 19-24 from the date of shipment or at BEKO USA's discretion, the date of installation. The purchase price of the Cover3More limited extended warranty is not prorated and the current published purchase price is always applied. Should the extended warranty coverage be purchased post-delivery or sale then the serial number of all products to which the warranty shall be extended must be provided to BEKO USA at the time of purchase. Subject to terms in this Section, BEKO USA will repair or replace, at its option, any products or components that are found to be defective or nonconforming, provided that Buyer gives written notice of the defect or nonconformity within the warranty period. Buyer shall make the product or component available for BEKO USA's inspection or, at BEKO USA's option, shall return the product or component to BEKO USA FOB its manufacturing facility designated by BEKO USA. BEKO USA will return the product or component to Buyer, freight prepaid, to any location in the continental United States. This warranty shall be void in the event of: (a) Buyer's performing any warranty repair work to the product, whether directly or indirectly, without first obtaining written authorization from BEKO USA; (b) any modifications or additions to the product not previously expressly approved in writing by BEKO USA; (c) use of non-authorized replacement parts on the product; (d) misuse or failure to maintain or service the product in accordance with BEKO USA recommendations and guidelines. The warranty excludes all normal maintenance services. This warranty applies only if Buyer has followed BEKO USA's approved maintenance schedules and procedures. THIS WARRANTY IS IN LIEU OF ALL OTHER WARRANTIES OR OBLIGATIONS, EXPRESSED OR IMPLIED. BEKO USA EXPRESSLY DISCLAIMS ALL IMPLIED WARRANTIES OF MERCHANTABILITY OR FITNESS FOR A PARTICULAR PURPOSE. BUYER'S EXCLUSIVE REMEDY FOR BREACH OF WARRANTY IS REPLACEMENT OR REPAIR, AT BEKO USA'S OPTION. BUYER'S SOLE REMEDY IS LIMITED TO REPAIR OR REPLACEMENT OF NON-CONFORMING GOODS. THERE ARE NO WARRANTIES WHICH EXTEND BEYOND THE PROVISIONS OF THESE TERMS AND CONDITIONS.

7. Warning to Users.

BUYER ACKNOWLEDGES THAT USE OF THE BEKO USA PRODUCTS REQUIRES CAUTION ON THE PART OF USERS AND THAT FAILURE TO USE SUCH CAUTION CAN CAUSE SERIOUS PERSONAL INJURY. BUYER SHALL INSTRUCT ITS EMPLOYEES AND ANY OTHER PERSONS WHO MAY COME IN CONTACT WITH THE PRODUCTS ON PROPER USE AND SHALL PLACE APPROPRIATE WARNINGS IN LOCATIONS REASONABLY NECESSARY TO ALERT SUCH EMPLOYEES AND OTHER PERSONS TO THE NEED FOR CAUTION IN CONNECTION WITH USE OF THE PRODUCTS. BUYER SHALL INDEMNIFY AND HOLD HARMLESS BEKO USA FROM ANY LOSS, CLAIM, OR DAMAGES, INCLUDING ATTORNEYS' FEES AT TRIAL AND ON APPEAL, CAUSED IN WHOLE OR IN PART BY BUYER'S FAILURE TO COMPLY WITH THE REQUIREMENTS OF THIS SECTION.

8. Limitations of Liability.

EXCEPT AS OTHERWISE EXPRESSLY PROVIDED IN THESE TERMS AND CONDITIONS IN NO EVENT WILL BEKO USA BE LIABLE FOR ANY DIRECT, INDIRECT, SPECIAL, INCIDENTAL, OR CONSEQUENTIAL DAMAGES OF ANY KIND, SUSTAINED FROM ANY CAUSE RELATING TO THE PRODUCT OR ARISING OUT OF ANY LEGAL THEORY, WHETHER BREACH OF CONTRACT, NEGLIGENCE OR STRICT TORT LIABILITY. IN NO EVENT SHALL BEKO USA BE LIABLE TO BUYER FOR ANY CLAIM, WHETHER BASED UPON BREACH OF CONTRACT, NEGLIGENCE, STRICT TORT LIABILITY OR ANY OTHER LEGAL THEORY, ARISING OUT OF OR RELATING TO THE PRODUCTS SOLD, IN AN AMOUNT EXCEEDING THE PURCHASE PRICE OF THE SUBJECT PRODUCT. ANY LAWSUIT AGAINST BEKO USA, ITS OFFICERS, DIRECTORS, EMPLOYEES, OR AFFILIATES, ARISING OUT OF OR RELATING TO THE SUBJECT PRODUCT, MUST BE FILED WITHIN ONE YEAR FROM SHIPMENT OF THE PRODUCT BY BEKO USA.

9. Disputes.

THIS SALE TRANSACTION SHALL BE DEEMED TO HAVE BEEN MADE AND ENTERED INTO IN ATLANTA, FULTON COUNTY, GEORGIA. THESE TERMS AND CONDITIONS SHALL BE CONSTRUED UNDER THE LAWS OF THE STATE OF GEORGIA. BUYER HEREBY EXPRESSLY AGREES THAT FOR ALL ACTIONS OR PROCEEDINGS ARISING OUT OF OR RELATING TO THESE TERMS AND CONDITIONS OR THE PRODUCT BUYER WAIVES ALL RIGHTS TO A JURY TRIAL, AND JURISDICTION AND VENUE SHALL BE PROPER AND LIE SOLELY IN THE COURTS OF FULTON COUNTY, GEORGIA AND SHALL, ACCORDINGLY, BE HEARD ONLY IN SUCH COURTS. ANY DISPUTE, CONTROVERSY OR CLAIM ARISING OUT OF OR RELATED TO THESE TERMS AND CONDITIONS OR THE PRODUCT SHALL BE SOLELY AND EXCLUSIVELY RESOLVED BY BINDING ARBITRATION IN FULTON COUNTY, GEORGIA PURSUANT TO THE EXPEDITED PROCEDURES OF THE COMMERCIAL ARBITRATION RULES OF THE AMERICAN ARBITRATION ASSOCIATION THEN IN EFFECT. ANY ARBITRATION AWARD SHALL BE FINAL AND CONCLUSIVE AND A JUDGMENT THEREON MAY BE ENTERED IN THE SUPERIOR COURT OF FULTON COUNTY, GEORGIA. THE ARBITRATOR MAY AWARD ATTORNEYS' FEES AND COSTS.

10. Export Restrictions.

Buyer shall at all times comply with United States laws and regulations governing export control. Buyer shall not use, lease, or sell any products purchased from BEKO USA in any country, or to any other purchaser or lessee in any country of destination specified in Buyer's order, except in a manner expressly permitted by such laws and regulations.

11. Patents.

If Buyer becomes aware of any claim or allegation that a BEKO USA product infringes the patent or other rights of any third party, Buyer shall immediately notify BEKO USA in writing and shall give BEKO USA sufficient information to evaluate, defend, and possibly settle the claim. BEKO USA shall thereafter at its own expense and option: (a) settle the claim; (b) procure for Buyer the right to use the product; (c) replace or modify the product; (d) remove the product and refund the purchase price; or (e) defend the claim. If Buyer complies with its obligations under this paragraph, BEKO USA, using legal counsel of its exclusive choice, shall defend Buyer against any infringement claim based upon Buyer's use of the BEKO USA product and shall pay any costs and damages finally awarded by a court of competent jurisdiction based upon a finding that the BEKO USA product infringes the rights of a third party. If a court of competent jurisdiction enjoins use of the product, BEKO USA shall, at its option, undertake one of the options described in Clauses (b), (c), and (d) above or appeal such decision. This indemnity shall not apply to BEKO USA products that have been made to the specification or design of Buyer or to any product or part not manufactured by BEKO USA. The rights set forth in this paragraph shall be the sole and exclusive rights of Buyer with respect to patent and other intellectual property rights.

12. Returns.

Products may be returned to BEKO USA only with BEKO USA's prior written authorization. Refunds, restocking fees, and any other disputed amounts are subject to the exclusive discretion of BEKO USA for ALL products. BEKO USA reserves the right to refuse the return of any product at any time and for any reason. In order to receive credit, parts must be returned in their original, complete packaging and in unused condition. If a part is returned without the original packaging, BEKO USA will deduct the necessary amount from the credit to cover the cost of repackaging the return. Equipment and parts may be returned within 60-days from the date of purchase. All items are subject to a 10% restocking fee.

13. Precedence.

These terms and conditions take precedence over Buyer's additional or different terms and conditions, and BEKO USA's agreement to sell products to Buyer, and any acceptance by Buyer, are specifically limited to these terms and conditions. In the absence of Buyer's signature Buyer shall be bound by all of these terms and conditions: (a) 10 days after Buyer receives these terms and conditions unless written notice of objection is given to BEKO USA within the 10-day period; (b) when Buyer issues any instructions to BEKO USA and BEKO USA makes a substantial beginning of manufacture of the products or commitments for their procurement; (c) with respect to any products for which payment has been made and accepted or which Buyer has received and accepted.

14. Entire Agreement.

THESE TERMS AND CONDITIONS TOGETHER WITH ALL INVOICES FROM BEKO USA CONSTITUTE THE ENTIRE AGREEMENT BETWEEN THE PARTIES WITH RESPECT TO THE SUBJECT PRODUCTS, AND ANY REPRESENTATIONS, PROMISES, WARRANTIES OR STATEMENTS THAT DIFFER IN ANY WAY THEREFROM SHALL BE GIVEN NO FORCE OF EFFECT. THESE TERMS AND CONDITIONS MAY NOT BE MODIFIED EXCEPT IN WRITING SIGNED BY BEKO USA.

Air Filtration



Alternative Filter Elements

original manufacturer replacement elements

Contents

original manufacturer replacement elements

BEKO Technologies	CLEARPOINT® X25, X5, X1 and XA	150
	CLEARPOINT® AC and Duplex filters	151
BelAir / Friulair	FT Series Grade P, S, X and Z	152
Alternative Replacement Elements		
Atlas Copco	DD, PD, and QD	153
	Old DD, PD, and QD	154
Balston	MTA, MTB, MTC, MTD, MTE, MCC, MCD, and MCE	155
CompAir	A, B, C, D, E and CD	156
	X1, XA and AC	157
Deltech	810, K, KC, and Color Change	158
Domnick Hunter	1994 - 2005 PF, AO, AA, and AX	159
	1994 - 2005 AR, ACS, AC, MV, and Ammonia filters	160
	1986 - 1994 PF, AO, AA, AX, and ACS	161
	pre-1986 MS, EPO, AC, CT, AOTS, and AATS	162
Finite	PU, C, CU, QU and AU	163
Gardner Denver	G, P, C, and V	164
Great Lakes	EGP, EGC, GP, and GC	165
Hankison	9, 7, 6, and 5	166
	3, 1, 9 Stainless Steel, and 7 Stainless Steel	167
	6, 5, 3, and 1 Stainless Steel	168
	T, A and H Standard / T, A and H Stainless Steel	169
Ingersoll Rand	IRP, IRH, and IRC	170
Kaeser	FS, PF, OR, OX, and VF	171
Pneumatech	P, C, and A	172
Sullair	PF, PH, and PC	173
Ultrafilter	90 Series: PE, MF, SMF, AK, USR and FF	174
	90 Series: HT/CR and HT/NX and 80 Series: V, FF, MF and SMF	175
	80 Series: AK, SRF, and HT/CR and HT/NX	176
Walker Filtration	X25, X5, X1 and XA	177
	AC and MV	178
Zander	V, Z, X, and A	179
Zeks	P, G, H and A	180

All products contained herein are subject to your discount for Price Group 83

Previous Generation CLEARPOINT® Filter Housings

X25 / 25 Micron	Element Model	List Price USD
FA020	FE361X25	\$90
FA030	FE371X25	\$95
FA055	FE511X25	\$138
FA076	FE711X25	\$169
FA105	FE811X25	\$181
FA106	FE731X25	\$211
FA126	FE821X25	\$251
FA153	FE831X25	\$343
FA203	FE831X25	\$343
FA205	FE851X25	\$396
FA250	FE951X25	\$530
FA305	FE951X25	\$530
FA306	FE961X25	\$657
FA308	FE981X25	\$767
FA391	FE139X25	\$927
FA483	3 x FE088X25	\$1,526
FA484	4 x FE088X25	\$2,034
FA686	6 x FE088X25	\$2,965
FA688	8 x FE088X25	\$3,049
FA810	10 x FE088X25	\$5,084
FA816	16 x FE088X25	\$8,134
FA824	24 x FE088X25	\$12,202

X5 / 5 Micron	Element Model	List Price USD
FA020	FE361X5	\$90
FA030	FE371X5	\$95
FA055	FE511X5	\$138
FA076	FE711X5	\$169
FA105	FE811X5	\$181
FA106	FE731X5	\$211
FA126	FE821X5	\$251
FA153	FE831X5	\$343
FA203	FE831X5	\$343
FA205	FE851X5	\$396
FA250	FE951X5	\$530
FA305	FE951X5	\$530
FA306	FE961X5	\$657
FA308	FE981X5	\$767
FA391	FE139X5	\$927
FA483	3 x FE088X5	\$1,526
FA484	4 x FE088X5	\$2,034
FA686	6 x FE088X5	\$2,965
FA688	8 x FE088X5	\$3,049
FA810	10 x FE088X5	\$5,084
FA816	16 x FE088X5	\$8,134
FA824	24 x FE088X5	\$12,202

XA / .01 Micron	Element Model	List Price USD
FA020	FE361XA	\$90
FA030	FE371XA	\$95
FA055	FE511XA	\$138
FA076	FE711XA	\$169
FA105	FE811XA	\$181
FA106	FE731XA	\$211
FA126	FE821XA	\$251
FA153	FE831XA	\$343
FA203	FE831XA	\$343
FA205	FE851XA	\$396
FA250	FE951XA	\$530
FA305	FE951XA	\$530
FA306	FE961XA	\$657
FA308	FE981XA	\$767
FA391	FE139XA	\$927
FA483	3 x FE088XA	\$1,526
FA484	4 x FE088XA	\$2,034
FA686	6 x FE088XA	\$2,965
FA688	8 x FE088XA	\$3,049
FA810	10 x FE088XA	\$5,084
FA816	16 x FE088XA	\$8,134
FA824	24 x FE088XA	\$12,202

Previous Generation CLEARPOINT® Filter Housings

AC / Activated Carbon	Element Model	List Price USD
FA020	FE361AC	\$90
FA030	FE371AC	\$95
FA055	FE511AC	\$138
FA076	FE711AC	\$169
FA105	FE811AC	\$181
FA106	FE731AC	\$211
FA126	FE821AC	\$251
FA153	FE831AC	\$343
FA203	FE831AC	\$343
FA205	FE851AC	\$396
FA250	FE951AC	\$530
FA305	FE951AC	\$530
FA306	FE961AC	\$657
FA308	FE981AC	\$767
FA391	FE139AC	\$927
FA483	3 x FE088AC	\$1,526
FA484	4 x FE088AC	\$2,034
FA686	6 x FE088AC	\$2,965
FA688	8 x FE088AC	\$3,049
FA810	10 x FE088AC	\$5,084
FA816	16 x FE088AC	\$8,134
FA824	24 x FE088AC	\$12,202

Duplex Filter	Element Model	List Price USD
D020XAC	FE361XA 1 st Stage	\$90
	FE381AC 2 nd Stage	\$82
D030XAC	FE371XA 1 st Stage	\$95
	FE381AC 2 nd Stage	\$82
D045XAC	FE051XA 1 st Stage	\$154
	FE001AC 2 nd Stage	\$114

Previous Generation Belair / Friulair FT Series

Grade P / 5 Micron	Element Model	List Price USD
FT30P	FETP30	\$53
FT45P	FETP45	\$66
FT65P	FETP65	\$75
FT125P	FETP125	\$109
FT200P	FETP200	\$158
FT300P	FETP300	\$191
FT450P	FETP450	\$248
FT600P	FETP600	\$270
FT900P	FETP900	\$426
FT1500P	FETP1500	\$549

Grade S / 1 Micron	Element Model	List Price USD
FT30S	FETS30	\$53
FT45S	FETS45	\$66
FT65S	FETS65	\$75
FT125S	FETS125	\$109
FT200S	FETS200	\$158
FT300S	FETS300	\$191
FT450S	FETS450	\$248
FT600S	FETS600	\$270
FT900S	FETS900	\$426
FT1500S	FETS1500	\$549

Grade X / .01 Micron	Element Model	List Price USD
FT30X	FETX30	\$53
FT45X	FETX45	\$66
FT65X	FETX65	\$75
FT125X	FETX125	\$109
FT200X	FETX200	\$158
FT300X	FETX300	\$191
FT450X	FETX450	\$248
FT600X	FETX600	\$270
FT900X	FETX900	\$426
FT1500X	FETX1500	\$549

Grade Z / Activated Carbon	Element Model	List Price USD
FT30Z	FETZ30	\$53
FT45Z	FETZ45	\$66
FT65Z	FETZ65	\$75
FT125Z	FETZ125	\$109
FT200Z	FETZ200	\$158
FT300Z	FETZ300	\$191
FT450Z	FETZ450	\$248
FT600Z	FETZ600	\$270
FT900Z	FETZ900	\$426
FT1500Z	FETZ1500	\$549

Atlas Copco DD, PD and QD

Grade DD	Element Model	List Price USD
DD6	FD009X1	\$104
DD13	FD017X1	\$132
DD25	FD030X1	\$200
DD40	FD058X1	\$236
DD65	FD145X1	\$304
DD85	FD145X1	\$304
DD170	FD220X1	\$423
DD195	FD220X1	\$423
DD295	FD330X1	\$500
DD375	FD430X1	\$599
DD400	FD430X1	\$599
DD500	FD620X1	\$827
DD900	3 x FD330X1	\$1,500
DD500F	1 x FD330X1	\$500
DD900F	3 x FD330X1	\$1,500
DD1200F	4 x FD330X1	\$2,000
DD1800F	6 x FD330X1	\$3,000
DD3000F	10 x FD330X1	\$5,000
DD4800F	16 x FD330X1	\$8,000
DD7200F	24 x FD330X1	\$12,000

Grade PD	Element Model	List Price USD
PD6	FD009XA	\$104
PD13	FD017XA	\$132
PD25	FD030XA	\$200
PD40	FD058XA	\$236
PD65	FD145XA	\$304
PD85	FD145XA	\$304
PD195	FD220XA	\$423
PD295	FD220XA	\$423
PD375	FD330XA	\$500
PD400	FD430XA	\$599
PD500	FD430XA	\$599
PD900	FD620XA	\$827
PD500F	3 x FD330XA	\$1,500
PD900F	1 x FD330XA	\$500
DD900F	3 x FD330XA	\$1,500
PD1200F	4 x FD330XA	\$2,000
PD1800F	6 x FD330XA	\$3,000
PD3000F	10 x FD330XA	\$5,000
PD4800F	16 x FD330XA	\$8,000
PD7200F	24 x FD330XA	\$12,000

Grade QD	Element Model	List Price USD
QD6	FD009XA	\$104
QD13	FD017XA	\$132
QD25	FD030XA	\$200
QD40	FD058XA	\$236
QD65	FD145XA	\$304
QD85	FD145XA	\$304
QD170	FD220XA	\$423
QD195	FD220XA	\$423
QD295	FD330XA	\$500
QD375	FD430XA	\$599
QD400	FD430XA	\$599
QD500	FD620XA	\$827
QD900	3 x FD330XA	\$1,500
QD500F	1 x FD330XA	\$500
QD900F	3 x FD330XA	\$1,500
QD1200F	4 x FD330XA	\$2,000
QD1800F	6 x FD330XA	\$3,000
QD3000F	10 x FD330XA	\$5,000
QD4800F	16 x FD330XA	\$8,000
QD7200F	24 x FD330XA	\$12,000

Atlas Copco Old Generation DD, PD and QD

Grade DD (old)	Element Model	List Price USD
2901-0190-00	FD009X1	\$98
2901-0191-00	FD017X1	\$125
2901-0234-00	FD030X1	\$189
2901-0192-00	FD058X1	\$223
2901-0193-00	FD145X1	\$288
2906-0194-00	FD220X1	\$401
2906-0212-00	FD430X1	\$568
2906-0213-00	FD620X1	\$784

Grade PD (old)	Element Model	List Price USD
2901-0195-00	FD009XA	\$104
2901-0196-00	FD017XA	\$132
2901-0233-00	FD030XA	\$200
2901-0197-00	FD058XA	\$236
2901-0198-00	FD145XA	\$304
2901-0199-00	FD220XA	\$423
2906-0214-00	FD430XA	\$599
2906-0215-00	FD620XA	\$827

Grade QD (old)	Element Model	List Price USD
2901-0201-00	FD009AC	\$104
2901-0202-00	FD017AC	\$132
2901-0203-00	FD030AC	\$200
2901-0204-00	FD058AC	\$236
2901-0235-00	FD145AC	\$304
2906-0205-00	FD145AC	\$304
2906-0206-00	FD220AC	\$423
2906-0216-00	FD430AC	\$599
2901-0217-00	FD620AC	\$827

Balston MTA, MTB, MTC, MTD, MTE, MCC, MCD and MCE

Grade MTA	Element Model	List Price USD
050-05 AAQ	FMTA1232	\$8
050-11 AAQ	FMTA1257	\$9
100-09 AAQ	FMTA2551	\$9
100-12 AAQ	FMTA2564	\$11
100-18 AAQ	FMTA2127	\$12
100-25 AAQ	FMTA2178	\$16
150-19 AAQ	FMTA3152	\$27
200-16 AAQ	FMTA5189	\$28
200-30 AAQ	FMTA5213	\$29
200-35 AAQ	FMTA5230	\$32
200-80 AAQ	FMTA5476	\$38

Grade MTB	Element Model	List Price USD
050-05 AQ	FMTB1232	\$8
050-11 AQ	FMTB1257	\$9
100-09 AQ	FMTB2551	\$9
100-12 AQ	FMTB2564	\$11
100-18 AQ	FMTB2127	\$12
100-25 AQ	FMTB2178	\$16
150-19 AQ	FMTB3152	\$27
200-16 AQ	FMTB5189	\$28
200-30 AQ	FMTB5213	\$29
200-35 AQ	FMTB5230	\$32
200-80 AQ	FMTB5476	\$38

Grade MTC	Element Model	List Price USD
050-05 BQ	FMTC1232	\$8
050-11 BQ	FMTC1257	\$9
100-09 BQ	FMTC2551	\$9
100-12 BQ	FMTC2564	\$11
100-18 BQ	FMTC2127	\$12
100-25 BQ	FMTC2178	\$16
150-19 BQ	FMTC3152	\$27
200-16 BQ	FMTC5189	\$28
200-30 BQ	FMTC5213	\$29
200-35 BQ	FMTC5230	\$32
200-80 BQ	FMTC5476	\$38

Grade MTD	Element Model	List Price USD
050-05 CQ	FMTD1232	\$8
050-11 CQ	FMTD1257	\$9
100-09 CQ	FMTD2551	\$9
100-12 CQ	FMTD2564	\$11
100-18 CQ	FMTD2127	\$12
100-25 CQ	FMTD2178	\$16
150-19 CQ	FMTD3152	\$27
200-16 CQ	FMTD5189	\$28
200-30 CQ	FMTD5213	\$29
200-35 CQ	FMTD5230	\$32
200-80 CQ	FMTD5476	\$38

Grade MTE	Element Model	List Price USD
050-05 DQ	FMTE1232	\$8
050-11 DQ	FMTE1257	\$9
100-09 DQ	FMTE2551	\$9
100-12 DQ	FMTE2564	\$11
100-18 DQ	FMTE2127	\$12
100-25 DQ	FMTE2178	\$16
150-19 DQ	FMTE3152	\$27
200-16 DQ	FMTE5189	\$28
200-30 DQ	FMTE5213	\$29
200-35 DQ	FMTE5230	\$32
200-80 DQ	FMTE5476	\$38

Grade MCC	Element Model	List Price USD
050-05 BX	FMCC1232	\$12
050-11 BX	FMCC1257	\$14
100-09 BX	FMCC2551	\$15
100-12 BX	FMCC2564	\$17
100-18 BX	FMCC2127	\$30
100-25 BX	FMCC2178	\$32
150-19 BX	FMCC3152	\$36
200-16 BX	FMCC5189	\$40
200-30 BX	FMCC5213	\$42
200-35 BX	FMCC5230	\$45
200-80 BX	FMCC5476	\$72

Grade MCD	Element Model	List Price USD
050-05 CX	FMCD1232	\$12
050-11 CX	FMCD1257	\$14
100-09 CX	FMCD2551	\$15
100-12 CX	FMCD2564	\$17
100-18 CX	FMCD2127	\$30
100-25 CX	FMCD2178	\$32
150-19 CX	FMCD3152	\$36
200-16 CX	FMCD5189	\$40
200-30 CX	FMCD5213	\$42
200-35 CX	FMCD5230	\$45
200-80 CX	FMCD5476	\$72

Grade MCE	Element Model	List Price USD
050-05 DX	FMCE1232	\$12
050-11 DX	FMCE1257	\$14
100-09 DX	FMCE2551	\$15
100-12 DX	FMCE2564	\$17
100-18 DX	FMCE2127	\$30
100-25 DX	FMCE2178	\$32
150-19 DX	FMCE3152	\$36
200-16 DX	FMCE5189	\$40
200-30 DX	FMCE5213	\$42
200-35 DX	FMCE5230	\$45
200-80 DX	FMCE5476	\$72

Compair A, B, C, D, E and CD

Grade A	Element Model	List Price USD
CE 0005 A	FD009X25	\$104
CE 0010 A	FD017X25	\$132
CE 0018 A	FD030X25	\$200
CE 0036 A	FD058X25	\$236
CE 0087 A	FD145X25	\$304
CE 0087 A	FD145X25	\$304
CE 0087 A	FD145X25	\$304
CE 0132 A	FD220X25	\$423
CE 0132 A	FD220X25	\$423
CE 0198 A	FD330X25	\$500
CE 0258 A	FD430X25	\$599
CE 0258 A	FD430X25	\$599
CE 0372 A	FD620X25	\$827

Grade B	Element Model	List Price USD
CE 0005 B	FD009X1	\$104
CE 0010 B	FD017X1	\$132
CE 0018 B	FD030X1	\$200
CE 0036 B	FD058X1	\$236
CE 0087 B	FD145X1	\$304
CE 0087 B	FD145X1	\$304
CE 0087 B	FD145X1	\$304
CE 0132 B	FD220X1	\$423
CE 0132 B	FD220X1	\$423
CE 0198 B	FD330X1	\$500
CE 0258 B	FD430X1	\$599
CE 0258 B	FD430X1	\$599
CE 0372 B	FD620X1	\$827

Grade C	Element Model	List Price USD
CE 0005 C	FD009XA	\$104
CE 0010 C	FD017XA	\$132
CE 0018 C	FD030XA	\$200
CE 0036 C	FD058XA	\$236
CE 0087 C	FD145XA	\$304
CE 0087 C	FD145XA	\$304
CE 0087 C	FD145XA	\$304
CE 0132 C	FD220XA	\$423
CE 0132 C	FD220XA	\$423
CE 0198 C	FD330XA	\$500
CE 0258 C	FD430XA	\$599
CE 0258 C	FD430XA	\$599
CE 0372 C	FD620XA	\$827

Grade D	Element Model	List Price USD
CE 0005 D	FD009AC	\$104
CE 0010 D	FD017AC	\$132
CE 0018 D	FD030AC	\$200
CE 0036 D	FD058AC	\$236
CE 0087 D	FD145AC	\$304
CE 0087 D	FD145AC	\$304
CE 0087 D	FD145AC	\$304
CE 0132 D	FD220AC	\$423
CE 0132 D	FD220AC	\$423
CE 0198 D	FD330AC	\$500
CE 0258 D	FD430AC	\$599
CE 0258 D	FD430AC	\$599
CE 0372 D	FD620AC	\$827

Grade E	Element Model	List Price USD
CE 0005 E	FD009X1	\$104
CE 0010 E	FD017X1	\$132
CE 0018 E	FD030X1	\$200
CE 0036 E	FD058X1	\$236
CE 0087 E	FD145X1	\$304
CE 0087 E	FD145X1	\$304
CE 0087 E	FD145X1	\$304
CE 0132 E	FD220X1	\$423
CE 0132 E	FD220X1	\$423
CE 0198 E	FD330X1	\$500
CE 0258 E	FD430X1	\$599
CE 0258 E	FD430X1	\$599
CE 0372 E	FD620X1	\$827

Grade CD	Element Model	List Price USD
CE 0005 C & CE 0005 D	FD009XA FD006AC	\$104 \$104
CE 0008 C & CE 0008 D	FD017XA FD013AC	\$132 \$104
CE 0018 C & CE 0015 D	FD030XA FD025AC	\$200 \$199
CE 0036 C & CE 0024 D	FD058XA FD040AC	\$236 \$235
CE 0087 C & CE 0039 D	FD145XA FD085AC	\$304 \$305
CE 0087 C & CE 0051 D	FD145XA FD085AC	\$304 \$305

Compair X1, XA and AC

Grade X1	Element Model	List Price USD
98245/121	FCOM21X1	\$103
98245/122	FCOM22X1	\$132
98245/123	FCOM23X1	\$201
98245/125	FCOM25X1	\$235
98245/126	FCOM26X1	\$305
98245/127	FCOM27X1	\$423
98245/128	FCOM28X1	\$500
98245/129	FCOM29X1	\$827
98245/130	FCOM30X1	\$599

Grade XA	Element Model	List Price USD
98245/141	FCOM41XA	\$103
98245/142	FCOM42XA	\$132
98245/143	FCOM43XA	\$201
98245/145	FCOM45XA	\$235
98245/146	FCOM46XA	\$305
98245/147	FCOM47XA	\$423
98245/148	FCOM48XA	\$500
98245/149	FCOM49XA	\$827
98245/150	FCOM50XA	\$599

Grade AC	Element Model	List Price USD
98245/161	FCOM61AC	\$106
98245/162	FCOM62AC	\$108
98245/163	FCOM63AC	\$115
98245/164	FCOM64AC	\$225
98245/165	FCOM65AC	\$146
98245/166	FCOM66AC	\$250
98245/167	FCOM67AC	\$423
98245/168	FCOM68AC	\$527
98245/169	FCOM69AC	\$872
98245/170	FCOM70AC	\$632

Grade X1 (old)	Element Model	List Price USD
98245/21	FCOM22X1	\$132
98245/22	FCOM23X1	\$201
98245/23	FCOM25X1	\$235
98245/25	FCOM26X1	\$305
98245/27	FCOM27X1	\$423
98245/28	FCOM28X1	\$500
98245/29	FCOM29X1	\$827

Grade XA (old)	Element Model	List Price USD
98245/41	FCOM42XA	\$129
98245/42	FCOM43XA	\$197
98245/43	FCOM45XA	\$228
98245/45	FCOM46XA	\$295
98245/47	FCOM47XA	\$411
98245/48	FCOM48XA	\$486
98245/49	FCOM49XA	\$804

Grade AC (old)	Element Model	List Price USD
98245/62	FCOM62AC	\$106
98245/65	FCOM65AC	\$140
98245/67	FCOM67AC	\$411
98245/68	FCOM68AC	\$486

Deltech 801, K, K and Color Change

810 Series	Element Model	List Price USD
811E	FDE811E	\$127
812E	FDE812E	\$184
813E	FDE813E	\$261
814E	FDE814E	\$360
815E	FDE815E	\$474
816E	FDE816E	\$615
817E	FDE817E	\$756
818E	FDE818E	\$855
819E	FDE819E	\$1,063
820E	2 x FDE820E	\$1,389
821E	3 x FDE820E	\$2,082
822E	4 x FDE820E	\$2,775
823E	6 x FDE820E	\$4,163
824E	8 x FDE820E	\$5,550
825E	10 x FDE820E	\$6,939
826E	15 x FDE820E	\$10,406
827E	20 x FDE820E	\$13,875
828E	25 x FDE820E	\$17,343
829E	30 x FDE820E	\$20,812

K Series*	Element Model	List Price USD
6K11E	FDAC110AC	\$414
6K11E (R)	FDAC110AC	\$414
6K12E	FDAC120AC	\$664
6K12E (R)	FDAC120AC	\$664
6K13E	FDAC130AC	\$1,061
6K13E (R)	FDAC130AC	\$1,061
6K14E	FDAC140AC	\$1,737
6K14E (R)	FDAC140AC	\$1,737
6K15E	FDAC150AC	\$2,120
6K15E (R)	FDAC150AC	\$2,120
6K16E	FDAC160AC	\$1,626
6K16E (R)	FDAC160AC	\$1,626

KC Series*	Element Model	List Price USD
6KC11E	FDAC110ACC	\$458
6KC12E	FDAC120ACC	\$728
6KC13E	FDAC130ACC	\$1,161
6KC14E	FDAC140ACC	\$1,908
6KC15E	FDAC150ACC	\$2,329
6KC16E	FDAC160ACC	\$1,784

100 Series Color Change*	Element Model	List Price USD
6K110E	FDE6110E	\$291
6K110E (R)	FDE6110E	\$291
6K120E	FDE6120E	\$466
6K120E (R)	FDE6120E	\$466
6K130E	FDE6130E	\$738
6K130E (R)	FDE6130E	\$738
6K140E	FDE6140E	\$1,218
6K140E (R)	FDE6140E	\$1,218
6K150E	FDE6150E	\$1,487
6K150E (R)	FDE6150E	\$1,487
6K160E	FDE4160E	\$1,143
6K160E (R)	FDE4160E	\$1,143
4170E (R)	FDE4170E	\$1,391

*Price includes six (6) replacement filter elements

Domnick Hunter 1994-2005 PF, AO, AA and AX

Grade PF	Element Model	List Price USD
K009PF	FD009X25	\$104
K017PF	FD017X25	\$132
K030PF	FD030X25	\$200
K058PF	FD058X25	\$236
K145PF	FD145X25	\$304
K220PF	FD220X25	\$423
K330PF	FD330X25	\$500
K430PF	FD430X25	\$599
K620PF	FD620X25	\$827

Grade AO	Element Model	List Price USD
K009AO	FD009X1	\$104
K017AO	FD017X1	\$132
K030AO	FD030X1	\$200
K058AO	FD058X1	\$236
K145AO	FD145X1	\$304
K220AO	FD220X1	\$423
K330AO	FD330X1	\$500
K430AO	FD430X1	\$599
K620AO	FD620X1	\$827

Grade AA	Element Model	List Price USD
K009AA	FD009XA	\$104
K017AA	FD017XA	\$132
K030AA	FD030XA	\$200
K058AA	FD058XA	\$236
K145AA	FD145XA	\$304
K220AA	FD220XA	\$423
K330AA	FD330XA	\$500
K430AA	FD430XA	\$599
K620AA	FD620XA	\$827

Grade AX	Element Model	List Price USD
K009AX	FD009XAA	\$127
K017AX	FD017XAA	\$156
K030AX	FD030XAA	\$240
K058AX	FD058XAA	\$276
K145AX	FD145XAA	\$361
K220AX	FD220XAA	\$526
K330AX	FD330XAA	\$600
K430AX	FD430XAA	\$718
K620AX	FD620XAA	\$990

Domnick Hunter 1994-2005 AR, ACS, AC, MV and NH

Grade AR	Element Model	List Price USD
K009AR	FD009X1	\$104
K017AR	FD017X1	\$132
K030AR	FD030X1	\$200
K058AR	FD058X1	\$236
K145AR	FD145X1	\$304
K220AR	FD220X1	\$423
K330AR	FD330X1	\$500
K430AR	FD430X1	\$599
K620AR	FD620XA	\$827

Grade ACS	Element Model	List Price USD
K009ACS	FD009AC	\$104
K017ACS	FD017AC	\$132
K030ACS	FD030AC	\$200
K058ACS	FD058AC	\$236
K145ACS	FD145AC	\$304
K220ACS	FD220AC	\$423
K330ACS	FD330AC	\$500
K430ACS	FD430AC	\$599
K620ACS	FD620AC	\$827

Grade AC	Element Model	List Price USD
K006AC	FD006AC	\$104
K013AC	FD013AC	\$104
K025AC	FD025AC	\$199
K040AC	FD040AC	\$235
K065AC	FD065AC	\$230
K085AC	FD085AC	\$305

Grade MV	Element Model	List Price USD
K025PL	FD025MV	\$156
K040PL	FD040MV	\$182
K085PL	FD085MV	\$242
K195PL	FD195MV	\$332
K400PL	FD400MV	\$481

Ammonia 1 micron	Element Model	List Price USD
C12MSDBNH3	FD12BX1NH3	\$283
C24MSDBNH3	FD24BX1NH3	\$405
C245MSDBNH4	FD24BX1NH4	\$681
C120MSDBNH5	FD24BX1NH5	\$356
C250MSDBNH6	FD24BX1NH6	\$505
C360MSDBNH7	FD360BX1NH7	\$835

Ammonia .01 micron	Element Model	List Price USD
C12DBNH3	FD12BNH3	\$283
C24DBNH3	FD24BNH3	\$405
C245DBNH4	FD24BNH4	\$681
C120DBNH5	FD24BNH5	\$356
C250DBNH6	FD24BNH6	\$505
C360DBNH7	FD360BNH7	\$835

Domnick Hunter 1986-1994 PF, AO, AA, AX and ACS

Grade PF	Element Model	List Price USD
K006PF	FD006X25	\$104
K013PF	FD013X25	\$132
K025PF	FD025X25	\$200
K040PF	FD040X25	\$236
K085PF	FD085X25	\$304
K195PF	FD195X25	\$423
K295PF	FD295X25	\$500
K400PF	FD400X25	\$599
K500PF	FD500X25	\$827

Grade AO	Element Model	List Price USD
K006AO	FD006X1	\$104
K013AO	FD013X1	\$132
K025AO	FD025X1	\$200
K040AO	FD040X1	\$236
K085AO	FD085X1	\$304
K195AO	FD195X1	\$423
K295AO	FD295X1	\$500
K400AO	FD400X1	\$599
K500AO	FD500X1	\$827

Grade AA	Element Model	List Price USD
K007AA	FD007XA	\$132
K011AA	FD011XA	\$200
K035AA	FD035XA	\$236
K060AA	FD060XA	\$304
K120AA	FD120XA	\$423
K200AA	FD200XA	\$500
K250AA	FD250XA	\$500
K300AA	FD300XA	\$827
K360AA	FD360XA	\$827

Grade AX	Element Model	List Price USD
K006AX	FD006XAA	\$98
K013AX	FD013XAA	\$125
K025AX	FD025XAA	\$189
K040AX	FD040XAA	\$223
K085AX	FD085XAA	\$289
K195AX	FD195XAA	\$401
K295AX	FD295XAA	\$474
K400AX	FD400XAA	\$568
K500AX	FD500XAA	\$784

Grade ACS	Element Model	List Price USD
K006ACS	FD006ACS	\$104
K013ACS	FD013ACS	\$132
K025ACS	FD025ACS	\$200
K040ACS	FD040ACS	\$236
K085ACS	FD085ACS	\$304
K195ACS	FD195ACS	\$423
K295ACS	FD295ACS	\$500
K400ACS	FD400ACS	\$599
K500ACS	FD500ACS	\$827

Domnick Hunter Pre-1986 MS, EPO, AC, CT, AOTS and AATS

Grade MS	Element Model	List Price USD
C4MS	FD4X1	\$156
C8MS	FD8X1	\$233
C12MSD	FD12DX1	\$409
C12MS	FD12X1	\$274
C12MSDB	FD12BX1	\$409
C24MSDB	FD24BX1	\$481
C155MSD	FD155X1	\$401
C245MSD	FD245X1	\$795

Grade EPO	Element Model	List Price USD
C2EPO	FD2XA	\$92
C3EPO	FD3XA	\$151
C4EPO	FD4XA	\$173
C8EPO	FD8XA	\$253
C12EPO	FD12XA	\$294
C24EPO	FD24XA	\$485
C12D	FD12DXA	\$423
C12DB	FD12BXA	\$423
C24DB	FD24BXA	\$485
C155D	FD155XA	\$460
C185D	FD185XA	\$465
C245D	FD245XA	\$827
C305D	FD305XA	\$723

Grade AC	Element Model	List Price USD
C4AC	FD4AC	\$165
C8AC	FD8AC	\$248
C12AC	FD12AC	\$291
C12ACDB	FD12ACB	\$431
C24ACDB	FD24ACB	\$511
C155ACD	FD155AC	\$452
C245ACD	FD245AC	\$843
ABN1	FD013AC	\$75
E011AC	FD011AC	\$101
E060AC	FD060AC	\$143
E120AC	FD120AC	\$431
E200AC	FD200AC	\$511
E250AC	FD250AC	\$511
E300AC	FD300AC	\$827
E360AC	FD360AC	\$827

Grade CT	Element Model	List Price USD
C3CT	FD3MV	\$149
C4CT	FD4MV	\$168
C8CT	FD8MV	\$249
C12CT	FD12MV	\$76
C12CTDB	FD12BMV	\$339
C24CTDB	FD24BMV	\$481
C125CTD	FD125MV	\$362
C155CTD	FD155MV	\$448
C185CTD	FD185NFBMV	\$772
C245CTD	FD245MV	\$827
E011CT	FD011MV	\$163
E035CT	FD035MV	\$191
E060CT	FD060MV	\$252
E120CT	FD120MV	\$347
E250CT	FD250MV	\$481
E360CT	FD360MV	\$827

Grade AATS	Element Model	List Price USD
E007AATS	FD007TXA	\$147
E011AATS	FD011TXA	\$147
E035AATS	FD0357XA	\$261
E060AATS	FD060TXA	\$341
E085AATS	FD085TXA	\$341
E120AATS	FD120TXA	\$477
K195AATS	FD195TXA	\$477
E200AATS	FD200TXA	\$477
E250AATS	FD250TXA	\$548
K295AATS	FD300TXA	\$548
E300AATS	FD360TXA	\$905
E360AATS	FD360TXA	\$905
K500AATS	FD360TXA	\$905

Finite PU, C, CU, QU and AU

Grade PU	Element Model	List Price USD
3PU10-25	FN100253PU	\$27
3PU10-050	FN100503PU	\$44
3PU15-060	FN150603PU	\$55
3PU15-095	FN150953PU	\$65
3PU25-130	FN251303PU	\$132
3PU25-187	FN251873PU	\$154
3PU25-235	FN252353PU	\$165
3PU35-280	FN352803PU	\$303
3PU51-280	FN512803PU	\$499
3PU85-250	FN852503PU	\$687
3PU85-360	FN853603PU	\$887

Grade C	Element Model	List Price USD
C10-025	FN10025C	\$30
C10-050	FN10050C	\$48
C15-060	FN15060C	\$56
C15-095	FN15095C	\$74

*Substitute for grade reference 10, 8, 6, 4 or 2

Grade CU	Element Model	List Price USD
CU10-25	FN100253CU	\$31
CU10-050	FN100503CU	\$50
CU15-060	FN150603CU	\$62
CU15-095	FN150953CU	\$80
CU25-130	FN251303CU	\$150
CU25-187	FN251873CU	\$154
CU25-235	FN252353CU	\$197
CU35-280	FN352803CU	\$347
CU51-280	FN512803CU	\$522
CU85-250	FN852503CU	\$694
CU85-360	FN853603CU	\$754

*Substitute for grade reference 10, 8, 6, 4 or 2

Grade QU	Element Model	List Price USD
QU10-025	FN100253QU	\$49
QU10-050	FN100503QU	\$83
QU15-060	FN150603QU	\$107
QU15-095	FN150953QU	\$130
QU25-130	FN251303QU	\$250
QU25-187	FN251873QU	\$265
QU25-235	FN252353QU	\$329
QU35-280	FN352803QU	\$617
QU51-280	FN512803QU	\$617
QU85-260	FN852503QU	\$789
QU85-360	FN853603QU	\$1,024

*Substitute for grade reference 10, 8, 6, 4 or 2

Grade AU	Element Model	List Price USD
AU10-25	FN10025AC	\$31
AU10-050	FN10050AC	\$50
AU15-060	FN15060AC	\$62
AU15-095	FN15095AC	\$80
AU25-130	FN25130AC	\$150
AU25-187	FN25187AC	\$154
AU25-235	FN25235AC	\$197
AU35-280	FN35280AC	\$347
AU51-280	FN51280AC	\$522
AU85-250	FN85250AC	\$694
AU85-360	FN85360AC	\$754

Gardner Denver G, P, C and V

Grade G	Element Model	List Price USD
FSH30GE	FWFH30GE	\$108
FSH65GE	FWFH65GE	\$164
FSH75GE	FWFH75GE	\$173
FSH100GE	FWFH100GE	\$195
FSH150GE	FWFH150GE	\$225
FSH225GE	FWFH225GE	\$254
FSH300GE	FWFH300GE	\$294
FSH450GE	FWFH450GE	\$371
FSH650GE	FWFH650GE	\$432
FSH700GE	FWFH700GE	\$464
FSH1000GE	FWFH1000GE	\$547
FSH1250GE	FWFH1250GE	\$717
FSH1500GE	FWFH1500GE	\$800

Grade P	Element Model	List Price USD
FSH30PE	FWFH30PE	\$108
FSH65PE	FWFH65PE	\$164
FSH75PE	FWFH75PE	\$173
FSH100PE	FWFH100PE	\$195
FSH150PE	FWFH150PE	\$225
FSH225PE	FWFH225PE	\$254
FSH300PE	FWFH300PE	\$294
FSH450PE	FWFH450PE	\$371
FSH650PE	FWFH650PE	\$432
FSH700PE	FWFH700PE	\$464
FSH1000PE	FWFH1000PE	\$547
FSH1250PE	FWFH1250PE	\$717
FSH1500PE	FWFH1500PE	\$800

Grade V	Element Model	List Price USD
FSH30VE	FWFH30VE	\$108
FSH65VE	FWFH65VE	\$164
FSH75VE	FWFH75VE	\$173
FSH100VE	FWFH100VE	\$195
FSH150VE	FWFH150VE	\$225
FSH225VE	FWFH225VE	\$254
FSH300VE	FWFH300VE	\$294
FSH450VE	FWFH450VE	\$371
FSH650VE	FWFH650VE	\$432
FSH700VE	FWFH700VE	\$464
FSH1000VE	FWFH1000VE	\$547
FSH1250VE	FWFH1250VE	\$717
FSH1500VE	FWFH1500VE	\$800

Great Lakes EGP, EGC, GP and GC

Grade EGP	Element Model	List Price USD
EGP-25	FN10025PU	\$28
EGP-30	FN10025PU	\$28
EGP-40	FN10025PU	\$28
EGP-65	FN10050PU	\$45
EGP-80	FN10050PU	\$45
EGP-130	FN15060PU	\$55
EGP-170	FN15060PU	\$55
EGP-230	FN15095PU	\$66
EGP-250	FN20130PU	\$90
EGP-370	FN20130PU	\$90
EGP-420	FN20130PU	\$90
EGP-540	FN20187PU	\$115
EGP-415/600	FN25130PU	\$129
EGP-625	FN25187PU	\$154
EGP-700	FN25187PU	\$154
EGP-920	FN25235PU	\$165
EGP-1250	FN25280PU	\$223
EGP-1330/1660	FN35280PU	\$303
EGP-1650	FN35280PU	\$303
EGP-2500	FN51280PU	\$499
EGP-3300	FN85250PU	\$529

Grade EGC	Element Model	List Price USD
EGC-15	FN10025CU6	\$31
EGC-20	FN10025CU6	\$31
EGC-40	FN10050CU6	\$50
EGC-50	FN10050CU6	\$50
EGC-80	FN15060CU6	\$63
EGC-100	FN15060CU6	\$66
EGC-140	FN15095CU6	\$80
EGC-220	FN20130CU6	\$101
EGC-250	FN20130CU6	\$101
EGC-325	FN20187CU6	\$134
EGC-255/350	FN25130CU6	\$150
EGC-350	FN25130CU6	\$150
EGC-375	FN25187CU6	\$154
EGC-420	FN25187CU6	\$154
EGC-550	FN25235CU6	\$197
EGC-750	FN25235CU6	\$197
EGC-900	FN35280CU6	\$347
EGC-1000	FN35280CU6	\$347
EGC-1500	FN51280CU6	\$614
EGC-2000	FN85250CU6	\$785

Grade GP	Element Model	List Price USD
EGP-25	FN10025PU	\$28
EGP-30	FN10025PU	\$28
EGP-40	FN10025PU	\$28
EGP-65	FN10050PU	\$45
EGP-80	FN10050PU	\$45
EGP-130	FN15060PU	\$55
EGP-170	FN15060PU	\$55
EGP-230	FN15095PU	\$66
EGP-415	FN20130PU	\$90
EGP-600	FN25187PU	\$115
EGP-750	FN25187PU	\$115
EGP-1035	FN25235PU	\$165
EGP-1330	FN35280PU	\$223
EGP-1660	FN35280PU	\$223
EGP-2500	FN51280PU	\$499
EGP-3300	FN85250PU	\$529

Grade GC	Element Model	List Price USD
EGA-15	FN10025AC	\$31
EGA-20	FN10025AC	\$31
EGA-25	FN10025AC	\$50
EGA-40	FN10050AC	\$50
EGA-50	FN10050AC	\$63
EGA-80	FN15060AC	\$66
EGA-100	FN15060AC	\$80
EGA-140	FN15095AC	\$101
EGA-220	FN20130AC	\$101
EGA-250	FN20130AC	\$134
EGA-325	FN20187AC	\$150
EGA-255/350	FN25130AC	\$150
EGA-375	FN25187AC	\$154
EGA-420	FN25187AC	\$154
EGA-550	FN25235AC	\$197
EGA-750	FN25280AC	\$197
EGA-1000	FN35280AC	\$347
EGA-800/1000	FN35280AC	\$347
EGA-1500	FN51280AC	\$614
EGA-2000	FN85250AC	\$785

Hankison 9, 7, And 5

Grade 9	Element Model	List Price USD
E9-12	FHKX5-12	\$62
E9-16	FHKX5-16	\$72
E9-20	FHKX5-20	\$104
E9-24	FHKX5-24	\$116
E9-28	FHKX5-28	\$158
E9-32	FHKX5-32	\$224
E9-36	FHKX5-36	\$294
E9-40	FHKX5-40	\$363
E9-44	FHKX5-44	\$376
E9-48	FHKX5-48	\$403
E9-54	FHKX5-54	\$367
E9-PV	FHKX5-PV	\$403

Grade 7	Element Model	List Price USD
E7-12	FHKX1-12	\$62
E7-16	FHKX1-16	\$72
E7-20	FHKX1-20	\$104
E7-24	FHKX1-24	\$116
E7-28	FHKX1-28	\$158
E7-32	FHKX1-32	\$224
E7-36	FHKX1-36	\$294
E7-40	FHKX1-40	\$363
E7-44	FHKX1-44	\$376
E7-48	FHKX1-48	\$403
E7-54	FHKX1-54	\$367
E7-PV	FHKX1-PV	\$403

Grade 5	Element Model	List Price USD
E5-12	FHKXA-12	\$62
E5-16	FHKXA-16	\$72
E5-20	FHKXA-20	\$104
E5-24	FHKXA-24	\$116
E5-28	FHKXA-28	\$158
E5-32	FHKXA-32	\$224
E5-36	FHKXA-36	\$294
E5-40	FHKXA-40	\$363
E5-44	FHKXA-44	\$376
E5-48	FHKXA-48	\$403
E5-54	FHKXA-54	\$367
E5-PV	FHKXA-PV	\$403

Hankison 3, 1, 9 Stainless Steel And 7 Stainless Steel

Grade 3	Element Model	List Price USD
E3-12	FHKXAA-12	\$56
E3-16	FHKXAA-16	\$67
E3-20	FHKXAA-20	\$92
E3-24	FHKXAA-24	\$148
E3-28	FHKXAA-28	\$185
E3-32	FHKXAA-32	\$207
E3-36	FHKXAA-36	\$266
E3-40	FHKXAA-40	\$326
E3-44	FHKXAA-44	\$345
E3-48	FHKXAA-48	\$462
E3-54	FHKXAA-54	\$335
E3-PV	FHKXAA-PV	\$374

Grade 1	Element Model	List Price USD
E1-12	FHKAC-12	\$80
E1-16	FHKAC-16	\$88
E1-20	FHKAC-20	\$109
E1-24	FHKAC-24	\$184
E1-28	FHKAC-28	\$231
E1-32	FHKAC-32	\$261
E1-36	FHKAC-36	\$288
E1-40	FHKAC-40	\$380
E1-44	FHKAC-44	\$406
E1-48	FHKAC-48	\$564
E1-54	FHKAC-54	\$389
E1-PV	FHKAC-PV	\$420

Grade 9 Stainless Steel	Element Model	List Price USD
E6-12S	FHKX5-12	\$70
E6-16S	FHKX5-16	\$80
E6-20S	FHKX5-20	\$114
E6-24S	FHKX5-24	\$121
E6-28S	FHKX5-28	\$174
E6-32S	FHKX5-32	\$244
E6-36S	FHKX5-36	\$322
E6-40S	FHKX5-40	\$397
E6-44S	FHKX5-44	\$310
E6-48S	FHKX5-48	\$443
E6-54S	FHKX5-54	\$403
E6-PVS	FHKX5-PV	\$443

Grade 7 Stainless Steel	Element Model	List Price USD
E5-12S	FHKX1-12	\$61
E5-16S	FHKX1-16	\$71
E5-20S	FHKX1-20	\$96
E5-24S	FHKX1-24	\$121
E5-28S	FHKX1-28	\$155
E5-32S	FHKX1-32	\$165
E5-36S	FHKX1-36	\$207
E5-40S	FHKX1-40	\$219
E5-44S	FHKX1-44	\$233
E5-48S	FHKX1-48	\$259
E5-54S	FHKX1-54	\$249
E5-PVS	FHKX1-PV	\$261

Hankison Stainless Steel 6, 5, 3 and 1

Grade 6 Stainless Steel	Element Model	List Price USD
E6-12S	FHKX1-12-SS	\$61
E6-16S	FHKX1-16-SS	\$71
E6-20S	FHKX1-20-SS	\$96
E6-24S	FHKX1-24-SS	\$121
E6-28S	FHKX1-28-SS	\$155
E6-32S	FHKX1-32-SS	\$165
E6-36S	FHKX1-36-SS	\$207
E6-40S	FHKX1-40-SS	\$219
E6-44S	FHKX1-44-SS	\$233
E6-48S	FHKX1-48-SS	\$259
E6-54S	FHKX1-54-SS	\$249
E6-PVS	FHKX1-PV-SS	\$261

Grade 5 Stainless Steel	Element Model	List Price USD
E5-12S	FHKXA-12-SS	\$75
E5-16S	FHKXA-16-SS	\$80
E5-20S	FHKXA-20-SS	\$107
E5-24S	FHKXA-24-SS	\$155
E5-28S	FHKXA-28-SS	\$194
E5-32S	FHKXA-32-SS	\$220
E5-36S	FHKXA-36-SS	\$290
E5-40S	FHKXA-40-SS	\$330
E5-44S	FHKXA-44-SS	\$375
E5-48S	FHKXA-48-SS	\$466
E5-54S	FHKXA-54-SS	\$341
E5-PVS	FHKXA-PV-SS	\$389

Grade 3 Stainless Steel	Element Model	List Price USD
E3-12S	FHKXAA-12-SS	\$81
E3-16S	FHKXAA-16-SS	\$88
E3-20S	FHKXAA-20-SS	\$110
E3-24S	FHKXAA-24-SS	\$174
E3-28S	FHKXAA-28-SS	\$208
E3-32S	FHKXAA-32-SS	\$233
E3-36S	FHKXAA-36-SS	\$293
E3-40S	FHKXAA-40-SS	\$359
E3-44S	FHKXAA-44-SS	\$411
E3-48S	FHKXAA-48-SS	\$511
E3-54S	FHKXAA-54-SS	\$440
E3-PVS	FHKXAA-PV-SS	\$427

Grade 1 Stainless Steel	Element Model	List Price USD
E1-12S	FHKAC-12-SS	\$97
E1-16S	FHKAC-16-SS	\$100
E1-20S	FHKAC-20-SS	\$127
E1-24S	FHKAC-24-SS	\$204
E1-28S	FHKAC-28-SS	\$256
E1-32S	FHKAC-32-SS	\$288
E1-36S	FHKAC-36-SS	\$321
E1-40S	FHKAC-40-SS	\$411
E1-44S	FHKAC-44-SS	\$462
E1-48S	FHKAC-48-SS	\$611
E1-54S	FHKAC-54-SS	\$420
E1-PVS	FHKAC-PV-SS	\$475

Hankison T, A And H Standard and Stainless Steel

Grade T	Element Model	List Price USD
0731-3	FHK7313P	\$57
0731-4	FHK7314P	\$84
0731-5	FHK7315P	\$109
0731-6	FHK7316P	\$157
0731-7	FHK7317P	\$199
0731-8	FHK7318P	\$200
0731-9	FHK7319P	\$208

Grade A	Element Model	List Price USD
0713-2	FHK7132C	\$75
0713-3	FHK7133C	\$96
0713-4	FHK7134C	\$155
0713-5	FHK7135C	\$224
0713-6	FHK7136C	\$287
0713-7	FHK7137C	\$345
0713-11	FHK71311C	\$370
0713-12	FHK71312C	\$334

Grade H	Element Model	List Price USD
0715-2	FHK7152C	\$92
0715-3	FHK7153C	\$114
0715-4	FHK7154C	\$191
0715-5	FHK7155C	\$277
0715-6	FHK7156C	\$310
0715-7	FHK7157C	\$401
0715-11	FHK71511C	\$424
0715-12	FHK71512C	\$389

Grade T Stainless Steel	Element Model	List Price USD
0731-3S	FHK7313P-SS	\$78
0731-4S	FHK7314P-SS	\$107
0731-5S	FHK7315P-SS	\$130
0731-6S	FHK7316P-SS	\$182
0731-7S	FHK7317P-SS	\$227
0731-8S	FHK7318P-SS	\$227
0731-9S	FHK7319P-SS	\$265

Grade A Stainless Steel	Element Model	List Price USD
0713-2S	FHK7132C-SS	\$92
0713-3S	FHK7133C-SS	\$115
0713-4S	FHK7134C-SS	\$185
0713-5S	FHK7135C-SS	\$265
0713-6S	FHK7136C-SS	\$315
0713-7S	FHK7137C-SS	\$379
0713-11S	FHK71311C-SS	\$427
0713-12S	FHK71312C-SS	\$365

Grade H Stainless Steel	Element Model	List Price USD
0715-2S	FHK7152C-SS	\$109
0715-3S	FHK7153C-SS	\$123
0715-4S	FHK7154C-SS	\$214
0715-5S	FHK7155C-SS	\$305
0715-6S	FHK7156C-SS	\$342
0715-7S	FHK7157C-SS	\$429
0715-11S	FHK71511C-SS	\$420
0715-12S	FHK71512C-SS	\$420

Ingersoll Rand IRP, IRC and IRH

Grade IRP	Element Model	List Price USD
IRP 25	FDE850X1	\$106
IRP 47	FDE850X1	\$106
IRP 65	FDE851X1	\$130
IRP 110	FDE852X1	\$157
IRP 180	FDE870X1	\$201
IRP 220	FDE871X1	\$201
IRP 280	FDE872X1	\$234
IRP 385	FDE876X1	\$307
IRP 580	FDE101X1	\$405
IRP 750	FDE102X1	\$405
IRP 1100	FDE111X1	\$449
IRP 1350	FDE113X1	\$487
IRP 1775	FDE201X1	\$745

Grade IRC	Element Model	List Price USD
IRC 25	FDE850AC	\$106
IRC 47	FDE853AC	\$130
IRC 65	FDE854AC	\$157
IRC 110	FDE854AC	\$157
IRC 180	FDE873AC	\$201
IRC 220	FDE874AC	\$201
IRC 580	FDE112AC	\$449
IRC 750	FDE121AC	\$487

Kaeser FS, PF, OR, OX and VF

Grade FS	Element Model	List Price USD
USFS20	FHKX5-12	\$61
USFS35	FHKX5-16	\$71
USFS60	FHKX5-20	\$103
USFS100	FHKX5-24	\$117
USFS170	FHKX5-28	\$157
USFS250	FHKX5-32	\$224
USFS375	FHKX5-36	\$293
USFS485	FHKX5-40	\$363
USFS625	FHKX5-44	\$375
USFS780	FHKX5-48	\$403
USFS500	FHKX5-54	\$367
USFSPV	FHKX5-PV	\$403

Grade PF	Element Model	List Price USD
USPF20	FHKX1-12	\$61
USPF35	FHKX1-16	\$71
USPF60	FHKX1-20	\$103
USPF100	FHKX1-24	\$117
USPF170	FHKX1-28	\$157
USPF250	FHKX1-32	\$224
USPF375	FHKX1-36	\$293
USPF485	FHKX1-40	\$363
USPF625	FHKX1-44	\$375
USPF780	FHKX1-48	\$403
USPF500	FHKX1-54	\$367
USPPV	FHKX1-PV	\$403

Grade OR	Element Model	List Price USD
USOR20	FHKXA-12	\$61
USOR35	FHKXA-16	\$71
USOR60	FHKXA-20	\$103
USOR100	FHKXA-24	\$117
USOR170	FHKXA-28	\$157
USOR250	FHKXA-32	\$224
USOR375	FHKXA-36	\$293
USOR485	FHKXA-40	\$363
USOR625	FHKXA-44	\$375
USOR780	FHKXA-48	\$403
USOR500	FHKXA-54	\$367
USORPV	FHKXA-PV	\$403

Grade OX	Element Model	List Price USD
USOX20	FHKXAA-12	\$61
USOX35	FHKXAA-16	\$71
USOX60	FHKXAA-20	\$103
USOX100	FHKXAA-24	\$117
USOX170	FHKXAA-28	\$157
USOX250	FHKXAA-32	\$224
USOX375	FHKXAA-36	\$293
USOX485	FHKXAA-40	\$363
USOX625	FHKXAA-44	\$375
USOX780	FHKXAA-48	\$403
USOX500	FHKXAA-54	\$367
USOXPV	FHKXAA-PV	\$403

Grade VF	Element Model	List Price USD
USVF20	FHKAC-12	\$61
USVF35	FHKAC-16	\$71
USVF60	FHKAC-20	\$103
USVF100	FHKAC-24	\$117
USVF170	FHKAC-28	\$157
USVF250	FHKAC-32	\$224
USVF375	FHKAC-36	\$293
USVF485	FHKAC-40	\$363
USVF625	FHKAC-44	\$375
USVF780	FHKAC-48	\$403
USVF500	FHKAC-54	\$367
USVFPV	FHKAC-PV	\$403

Pneumatech P, C and A

Grade P	Element Model	List Price USD
P25-10	FN10050PU	\$45
P50-10	FN10050PU	\$45
P60-15	FN15060PU	\$55
P95-15	FN15095PU	\$66
P130-20	FN20130PU	\$90
P187-20	FN20187PU	\$115
P130-25	FN25130PU	\$129
P235-25	FN25235PU	\$165
P280-25	FN25280PU	\$223
P280-35	FN35280PU	\$303
P280-51	FN51280PU	\$499
P250-85	FN85250PU	\$529
P360-85	FN85360PU	\$741

Grade C	Element Model	List Price USD
*25-10	FN10025CU6	\$31
*50-10	FN10050CU6	\$50
*60-15	FN15060CU6	\$66
*95-15	FN15095CU6	\$80
*130-20	FN20130CU6	\$101
*187-20	FN20187CU6	\$134
*130-25	FN25130CU6	\$150
*187-25	FN25187CU6	\$154
*235-25	FN25235CU6	\$197
*280-25	FN25280CU6	\$201
*280-35	FN35280CU6	\$347
*280-51	FN51280CU6	\$614
*250-85	FN85250CU6	\$785
*360-85	FN85360CU6	\$641

*Substitute for grade reference C or Q

Grade A	Element Model	List Price USD
A25-10	FN10025AC	\$31
A50-10	FN10050AC	\$50
A60-15	FN15060AC	\$62
A95-15	FN15095AC	\$101
A130-20	FN20130AC	\$101
A187-20	FN20187AC	\$150
A130-25	FN25130AC	\$150
A187-25	FN25187AC	\$154
A235-25	FN25235AC	\$197
A280-25	FN25280AC	\$197
A280-35	FN35280AC	\$347
A280-51	FN51280AC	\$614
A250-85	FN85250AC	\$785
A280-85	FN85250AC	\$785
A360-85	FN85360AC	\$641

Sullair PF, PH and PC

Grade PF	Element Model	List Price USD
25 0024 423	FD009X1	\$103
25 0024 424	FD017X1	\$132
25 0024 425	FD030X1	\$199
25 0024 426	FD058X1	\$235
25 0024 427	FD145X1	\$304
25 0024 428	FD220X1	\$423
25 0024 429	FD330X1	\$500
25 0024 430	FD620X1	\$827
25 0024 644	FD430X1	\$599

Grade PH	Element Model	List Price USD
25 0024 431	FD009XA	\$103
25 0024 432	FD017XA	\$132
25 0024 433	FD030XA	\$199
25 0024 434	FD058XA	\$235
25 0024 435	FD145XA	\$304
25 0024 436	FD220XA	\$423
25 0024 437	FD330XA	\$500
25 0024 438	FD620XA	\$827
25 0024 645	FD430XA	\$599

Grade PC	Element Model	List Price USD
25 0024 439	FD220AC	\$526
25 0024 440	FD330AC	\$600
25 0024 441	FD620AC	\$990
25 0024 646	FD430AC	\$718

Ultrafilter 90 Series

Grade PE	Element Model	List Price USD
PE 0205	FUV0205	\$75
PE 0305	FUV0305	\$83
PE 0310	FUV0310	\$93
PE 0410	FUV0410	\$101
PE 0420	FUV0420	\$138
PE 0520	FUV0520	\$190
PE 0525	FUV0525	\$226
PE 0725	FUV0725	\$278
PE 0730	FUV0730	\$352
PE 1030	FUV1030	\$411
PE 1530	FUV1530	\$540
PE 2030	FUV2030	\$636
PE 3030	FUV3030	\$786
PE 3050	FUV3050	\$1009

Grade MF	Element Model	List Price USD
MF 0205	FUMF0205	\$83
MF 0305	FUMF0305	\$97
MF 0310	FUMF0310	\$106
MF 0410	FUMF0410	\$117
MF 0420	FUMF0420	\$154
MF 0520	FUMF0520	\$210
MF 0525	FUMF0525	\$248
MF 0725	FUMF0725	\$307
MF 0730	FUMF0730	\$381
MF 1030	FUMF1030	\$449
MF 1530	FUMF1530	\$583
MF 2030	FUMF2030	\$696
MF 3030	FUMF3030	\$865
MF 3050	FUMF3050	\$1,100

Grade SMF	Element Model	List Price USD
SMF 0205	FUSM0205	\$92
SMF 0305	FUSM0305	\$107
SMF 0310	FUSM0310	\$117
SMF 0410	FUSM0410	\$133
SMF 0420	FUSM0420	\$184
SMF 0520	FUSM0520	\$235
SMF 0525	FUSM0525	\$273
SMF 0725	FUSM0725	\$336
SMF 0730	FUSM0730	\$411
SMF 1030	FUSM1030	\$487
SMF 1530	FUSM1530	\$627
SMF 2030	FUSM2030	\$755
SMF 3030	FUSM3030	\$936
SMF 3050	FUSM3050	\$1,191

Grade AK	Element Model	List Price USD
AK 0205	FUAC0205	\$83
AK 0305	FUAC0305	\$97
AK 0310	FUAC0310	\$106
AK 0410	FUAC0410	\$117
AK 0420	FUAC0420	\$154
AK 0520	FUAC0520	\$210
AK 0525	FUAC0525	\$248
AK 0725	FUAC0725	\$307
AK 0730	FUAC0730	\$382
AK 1030	FUAC1030	\$449
AK 1530	FUAC1530	\$583
AK 2030	FUAC2030	\$696
AK 3030	FUAC3030	\$861
AK 3050	FUAC3050	\$1,100

Grade USR	Element Model	List Price USD
USR 02/05	FUSR0205	\$281
USR 03/05	FUSR0305	\$327
USR 03/10	FUSR0310	\$360
USR 04/10	FUSR0410	\$385
USR 04/20	FUSR0420	\$401
USR 05/20	FUSR0520	\$449
USR 05/25	FUSR0525	\$503
USR 07/25	FUSR0725	\$626
USR 07/30	FUSR0730	\$717
USR 10/30	FUSR1030	\$874
USR 15/30	FUSR1530	\$1,023
USR 20/30	FUSR2030	\$1,322
USR 30/30	FUSR3030	\$1,526
USR 30/50	FUSR3050	\$2,591

Grade FF	Element Model	List Price USD
FF 02/05	FUFF0205	\$92
FF 03/05	FUFF0305	\$107
FF 03/10	FUFF0310	\$116
FF 04/10	FUFF0410	\$130
FF 04/20	FUFF0420	\$169
FF 05/20	FUFF0520	\$231
FF 05/25	FUFF0525	\$273
FF 07/25	FUFF0725	\$336
FF 07/30	FUFF0730	\$421
FF 10/30	FUFF1030	\$495
FF 15/30	FUFF1530	\$641
FF 20/30	FUFF2030	\$767
FF 30/30	FUFF3030	\$946
FF 30/50	FUFF3050	\$1,210

Ultrafilter 90 Series

Grade HT/CR or HT/NX	Element Model	List Price USD
FF 0205	FUFF0205	\$83
FF 0305	FUFF0305	\$97
FF 0310	FUFF0310	\$106
FF 0410	FUFF0410	\$117
FF 0420	FUFF0420	\$154
FF 0520	FUFF0520	\$211
FF 0525	FUFF0525	\$248
FF 0725	FUFF0725	\$307
FF 0730	FUFF0730	\$382
FF 1030	FUFF1030	\$449
FF 1530	FUFF1530	\$583
FF 2030	FUFF2030	\$696
FF 3030	FUFF3030	\$865
FF 3050	FUFF3050	\$1,100

Please state model and grade when ordering!

For example: FUFF0520HT/NX - Not doing so will cause your order to be delayed.

Ultrafilter 80 Series

Grade V	Element Model	List Price USD
V 3/1	FUV310	\$106
V 3/1.5	FUV315	\$120
V 4/1.5	FUV415	\$150
V 4/2.5	FUV425	\$189
V 5/2.5	FUV525	\$240
V 5/3	FUV530	\$292
V 10/3	FUV103	\$397
V 15/3	FUV153	\$526
V 20/3	FUV203	\$614
V 30/3	FUV303	\$755
V 30/5	FUV305	\$936

Grade FF	Element Model	List Price USD
FF 3/1	FUFF310	\$106
FF 3/1.5	FUFF315	\$120
FF 4/1.5	FUFF415	\$150
FF 4/2.5	FUFF425	\$189
FF 5/2.5	FUFF525	\$240
FF 5/3	FUFF530	\$292
FF 10/3	FUFF103	\$397
FF 15/3	FUFF153	\$526
FF 20/3	FUFF203	\$614
FF 30/3	FUFF303	\$755
FF 30/5	FUFF305	\$936

Grade MF	Element Model	List Price USD
MF 3/1	FUMF310	\$112
MF 3/1.5	FUMF315	\$133
MF 4/1.5	FUMF415	\$165
MF 4/2.5	FUMF425	\$209
MF 5/2.5	FUMF525	\$269
MF 5/3	FUMF530	\$329
MF 10/3	FUMF103	\$449
MF 15/3	FUMF153	\$582
MF 20/3	FUMF203	\$694
MF 30/3	FUMF303	\$861
MF 30/5	FUMF305	\$1,098

Grade SMF	Element Model	List Price USD
SMF 3/1	FUSM310	\$120
SMF 3/1.5	FUSM315	\$143
SMF 4/1.5	FUSM415	\$181
SMF 4/2.5	FUSM425	\$234
SMF 5/2.5	FUSM525	\$300
SMF 5/3	FUSM530	\$368
SMF 10/3	FUSM103	\$487
SMF 15/3	FUSM153	\$626
SMF 20/3	FUSM203	\$755
SMF 30/3	FUSM303	\$935
SMF 30/5	FUSM305	\$1,190

Ultrafilter 80 Series

Grade AK	Element Model	List Price USD
AK 3/1	FUAC310	\$120
AK 3/1.5	FUAC315	\$143
AK 4/1.5	FUAC415	\$181
AK 4/2.5	FUAC425	\$234
AK 5/2.5	FUAC525	\$299
AK 5/3	FUAC530	\$368
AK 10/3	FUAC103	\$487
AK 15/3	FUAC153	\$626
AK 20/3	FUAC203	\$755
AK 30/3	FUAC303	\$935
AK 30/5	FUAC305	\$1,190

Grade SRF	Element Model	List Price USD
SRF 3/1	FUSR310	\$360
SRF 3/1.5	FUSR315	\$373
SRF 4/1.5	FUSR415	\$385
SRF 4/2.5	FUSR425	\$401
SRF 5/2.5	FUSR525	\$503
SRF 5/3	FUSR530	\$516
SRF 10/3	FUSR103	\$874
SRF 15/3	FUSR153	\$1,023
SRF 20/3	FUSR203	\$1,322
SRF 30/3	FUSR303	\$1,526
SRF 30/5	FUSR305	\$2,591

Grade HT/CR or HT/NX	Element Model	List Price USD
FF/MF/SMF 3/1	FUFF / FUMF / FUSM310	\$138
FF/MF/SMF 3/1.5	FUFF / FUMF / FUSM315	\$174
FF/MF/SMF 4/1.5	FUFF / FUMF / FUSM415	\$211
FF/MF/SMF 4/2.5	FUFF / FUMF / FUSM425	\$234
FF/MF/SMF 5/2.5	FUFF / FUMF / FUSM525	\$291
FF/MF/SMF 5/3	FUFF / FUMF / FUSM530	\$388
FF/MF/SMF 10/3	FUFF / FUMF / FUSM730	\$437
FF/MF/SMF 15/3	FUFF / FUMF / FUSM153	\$718
FF/MF/SMF 20/3	FUFF / FUMF / FUSM203	\$880
FF/MF/SMF 30/3	FUFF / FUMF / FUSM303	\$1,083
FF/MF/SMF 30/5	FUFF / FUMF / FUSM305	\$1,326

Please state model and grade when ordering!

For example: FUFF730HT/NX - Not doing so will cause your order to be delayed.

Walker Filtration X25, X5, X1 and XA

Grade X25	Element Model	List Price USD
E361X25	FE361X25	\$90
E371X25	FE371X25	\$95
E511X25	FE511X25	\$138
E711X25	FE711X25	\$169
E811X25	FE811X25	\$181
E731X25	FE731X25	\$211
E821X25	FE821X25	\$251
E831X25	FE831X25	\$343
E851X25	FE851X25	\$396
E1251X25	FE951X25	\$530
E1261X25	FE961X25	\$657
E1281X25	FE981X25	\$767
E88X25	FE088X25	\$526

Grade X5	Element Model	List Price USD
E361X5	FE361X5	\$90
E371X5	FE371X5	\$95
E511X5	FE511X5	\$138
E711X5	FE711X5	\$169
E811X5	FE811X5	\$181
E731X5	FE731X5	\$211
E821X5	FE821X5	\$251
E831X5	FE831X5	\$343
E851X5	FE851X5	\$396
E1251X5	FE951X5	\$530
E1261X5	FE961X5	\$657
E1281X5	FE981X5	\$767
E88X5	FE088X5	\$526

Grade X1	Element Model	List Price USD
E361X1	FE361X1	\$90
E371X1	FE371X1	\$95
E511X1	FE511X1	\$138
E711X1	FE711X1	\$169
E811X1	FE811X1	\$181
E731X1	FE731X1	\$211
E821X1	FE821X1	\$251
E831X1	FE831X1	\$343
E851X1	FE851X1	\$396
E1251X1	FE951X1	\$530
E1261X1	FE961X1	\$657
E1281X1	FE981X1	\$767
E88X1	FE088X1	\$526

Grade XA	Element Model	List Price USD
E361XA	FE361XA	\$90
E371XA	FE371XA	\$95
E511XA	FE511XA	\$138
E711XA	FE711XA	\$169
E811XA	FE811XA	\$181
E731XA	FE731XA	\$211
E821XA	FE821XA	\$251
E831XA	FE831XA	\$343
E851XA	FE851XA	\$396
E1251XA	FE951XA	\$530
E1261XA	FE961XA	\$657
E1281XA	FE981XA	\$767
E88XA	FE088XA	\$526

Walker Filtration AC and MV

Grade AC	Element Model	List Price USD
E361AC	FE361AC	\$90
E371AC	FE371AC	\$95
E511AC	FE511AC	\$138
E711AC	FE711AC	\$169
E811AC	FE811AC	\$181
E731AC	FE731AC	\$211
E821AC	FE821AC	\$251
E831AC	FE831AC	\$343
E851AC	FE851AC	\$396
E1251AC	FE951AC	\$530
E1261AC	FE961AC	\$657
E1281AC	FE981AC	\$767
E88AC	FE088AC	\$526

Medical Vacuum	Element Model	List Price USD
E511MV	FE511MV	\$137
E521MV	FE521MV	\$169
E811MV	FE811MV	\$180
E821MV	FE821MV	\$251
E831MV	FE831MV	\$343
E851MV	FE851MV	\$395
E1261MV	FE961MV	\$657
E1281MV	FE981MV	\$767
E88MV	FE088MV	\$526

Zander V, Z, X and A

Grade V	Element Model	List Price USD
1030 V	FZV1030	\$64
1050 V	FZV1050	\$97
1070 V	FZV1070	\$123
1140 V	FZV1140	\$147
2010 V	FZV2010	\$190
2020 V	FZV2020	\$253
2030 V	FZV2030	\$313
2050 V	FZV2050	\$410
3050 V	FZV3050	\$474
3075 V	FZV3075	\$572
5060 V	FZV5060	\$760
5075 V	FZV5075	\$825

Grade Z	Element Model	List Price USD
1030 Z	FZZ1030	\$64
1050 Z	FZZ1050	\$97
1070 Z	FZZ1070	\$123
1140 Z	FZZ1140	\$147
2010 Z	FZZ2010	\$190
2020 Z	FZZ2020	\$253
2030 Z	FZZ2030	\$313
2050 Z	FZZ2050	\$410
3050 Z	FZZ3050	\$474
3075 Z	FZZ3075	\$572
5060 Z	FZZ5060	\$760
5075 Z	FZZ5075	\$825

Grade X	Element Model	List Price USD
1030 X	FZX1030	\$64
1050 X	FZX1050	\$97
1070 X	FZX1070	\$123
1140 X	FZX1140	\$147
2010 X	FZX2010	\$190
2020 X	FZX2020	\$253
2030 X	FZX2030	\$313
2050 X	FZX2050	\$410
3050 X	FZX3050	\$474
3075 X	FZX3075	\$572
5060 X	FZX5060	\$760
5075 X	FZX5075	\$825

Grade A	Element Model	List Price USD
1030 A	FZA1030	\$64
1050 A	FZA1050	\$97
1070 A	FZA1070	\$123
1140 A	FZA1140	\$147
2010 A	FZA2010	\$190
2020 A	FZA2020	\$253
2030 A	FZA2030	\$313
2050 A	FZA2050	\$410
3050 A	FZA3050	\$474
3075 A	FZA3075	\$572
5060 A	FZA5060	\$760
5075 A	FZA5075	\$825

Zeks P, G, H and A

Grade P	Element Model	List Price USD
E15P	FEZK015X5	\$64
E30P	FEZK030X5	\$97
E32P	FEZK032X5	\$123
E65P	FEZK065X5	\$149
E80P	FEZK080X5	\$190
E100P	FEZK100X5	\$253
E150P	FEZK150X5	\$313
E250P	FEZK250X5	\$410
E300P	FEZK300X5	\$474
E500P	FEZK500X5	\$576
E650P	FEZK650X5	\$760
E1000P	FEZK1000X5	\$825
E1250P	FEZK1250X5	\$489
E1600P	FEZK1600X5	\$654

Grade G	Element Model	List Price USD
E15G	FEZK015X1	\$56
E30G	FEZK030X1	\$58
E32G	FEZK032X1	\$64
E65G	FEZK065X1	\$80
E80G	FEZK080X1	\$106
E100G	FEZK100X1	\$141
E150G	FEZK150X1	\$159
E250G	FEZK250X1	\$279
E300G	FEZK300X1	\$296
E500G	FEZK500X1	\$373
E650G	FEZK650X1	\$406
E1000G	FEZK1000X1	\$511
E1250G	FEZK1250X1	\$559
E1600G	FEZK1600X1	\$747

Grade H	Element Model	List Price USD
E15H	FEZK015XAA	\$56
E30H	FEZK030XAA	\$58
E32H	FEZK032XAA	\$64
E65H	FEZK065XAA	\$80
E80H	FEZK080XAA	\$106
E100H	FEZK100XAA	\$141
E150H	FEZK150XAA	\$159
E250H	FEZK250XAA	\$279
E300H	FEZK300XAA	\$296
E500H	FEZK500XAA	\$373
E650H	FEZK650XAA	\$406
E1000H	FEZK1000XAA	\$511
E1250H	FEZK1250XAA	\$559
E1600H	FEZK1600XAA	\$747

Grade A	Element Model	List Price USD
E15A	FEZK015AC	\$56
E30A	FEZK030AC	\$58
E32A	FEZK032AC	\$64
E65A	FEZK065AC	\$80
E80A	FEZK080AC	\$106
E100A	FEZK100AC	\$141
E150A	FEZK150AC	\$159
E250A	FEZK250AC	\$279
E300A	FEZK300AC	\$296
E500A	FEZK500AC	\$373
E650A	FEZK650AC	\$406
E1000A	FEZK1000AC	\$511
E1250A	FEZK1250AC	\$559
E1600A	FEZK1600AC	\$747

Reliable | Efficient | Innovative

What can we do for you?



BEKO TECHNOLOGIES CORP.
900 Great Southwest Pkwy SW
Atlanta, GA 30336
USA
Phone +1 (404) 924-6900
www.bekousa.com

